

## Module 4b: Sedimentation and Wetlands for Stormwater Control

Excerpted from: Pitt, R. *Stormwater Quality Management*, forthcoming.

Introduction .....	3
Expected Detention Pond Performance .....	4
Potential Detention Pond Problems .....	4
Wet Detention Pond Design Guidelines to Minimize Potential Problems.....	5
Required Stormwater Detention Pond Maintenance.....	5
Basic Wet Detention Pond Design Guidelines .....	6
Wet Detention Pond Costs.....	6
Pond Size Calculation.....	6
Background.....	7
Multiple Benefits of Detention Facilities.....	7
Dry Ponds .....	8
Wet Detention Ponds.....	8
Extended Detention (Combination) Ponds .....	9
Roof Storage.....	9
Up-Sized Pipes .....	9
Underground Rock-Filled Detention .....	9
Use with Other Controls .....	10
Examples of Detention Pond Performance.....	10
Chemical Assisted Sedimentation .....	10
Full-scale Demonstrations .....	14
Oil/Water Separators .....	18
Gravity Separation.....	19
Coalescing Plate Interceptor Oil/Water Separators .....	20
Impingement Coalescers and Filtration Devices .....	21
Maintenance of Oil/Water Separators.....	21
Performance of Oil/Water Separators for Treating Stormwater .....	22
Problems With Wet Detention Ponds .....	23
Safety of Wet Detention Ponds.....	23
Nuisance Conditions in Wet Detention Ponds and Degraded Water Quality .....	25
Attitudes of Nearby Residents and Property Values.....	25
Maintenance Requirements of Wet Detention Ponds .....	26
Routine Maintenance Requirements.....	26
Mowing.....	26
Debris and Litter Removal.....	26
Inspections.....	27
Sediment Removal from Wet Detention Ponds.....	27
Problems with Contaminated Sediments in Wet Detention Ponds .....	28
Vegetation Removal from Wet Detention Ponds.....	28
Detention Pond Costs .....	29
Guidelines To Enhance Pond Performance .....	32
Insect Control and Fish Stocking.....	32
Aquatic Plants for Detention Ponds.....	32
Locating Ponds .....	40
Pond Surface Area and Shape.....	45
Pond Water Depth .....	45
Pond Side Slopes .....	46

Internal Baffles .....	46
Outlet Structures .....	46
Emergency Spillways .....	47
Multiple Detention Ponds and their use With Other Control Devices .....	47
Enhancing Pond Performance During Severe Winter Conditions .....	47
Detention Pond Design Fundamentals .....	49
Upflow Velocity .....	50
Effects of Short-Circuiting on Particulate Removals in Wet Detention Ponds.....	53
Residence Time and Extended Detention Ponds .....	56
Particle Size .....	58
Particle Settling Velocities .....	63
Pond Water Losses and Liners .....	65
Clay Blankets.....	69
Waterproof Linings.....	69
Flow Rate Reductions In Water Quality Ponds .....	69
Control of Pollutants Other Than Suspended Solids .....	69
Natural Bacterial Dieoff in Detention Ponds .....	71
Design Based on NURP Detention Pond Monitoring Results .....	72
Importance of Reservoir Routing .....	74
Introduction To Storage-Indication Method .....	74
Outflow Rates From Discharge Control Devices .....	74
Stage-Area and Storage-Indication Curve Development.....	78
Storage-Indication Calculation Procedure .....	80
Selecting Outflow Control Devices To Meet Water Quality Objectives .....	87
Wet Pond Design Criteria for Water Quality.....	89
The Use of the DETPOND Program to Statistically Evaluate Wet Pond Performance.....	96
Example Pond Performance Using Suggested Design Specifications and DETPOND.....	97
DETPOND Verification using Data Collected at the Monroe St. Detention Pond, Madison, WI.....	102
Method of Investigation.....	106
Data Analysis and Observations .....	106
Hydrograph/Flow Calibration.....	106
Particle Size Distributions and Short-Circuiting.....	114
Monroe St. Pond Verification Conclusions .....	115
Verification Based on Measured Performance at a Landfill Pond in Birmingham, AL .....	116
Issues Associated with Using a Continuous Record of Rains vs. a Single Event Storm .....	120
Stream Habitat Benefits Associated with Peak Flow Reduction Criteria .....	121
Untreated Flows Associated with Single-Event Criteria .....	122
Benefits of Using Continuous, Long-Term Simulations .....	122
Example Use of DETPOND and Wet Detention Pond Analyses .....	127
Analysis of the Wet Stormwater Detention Pond for the Brook Highland Shopping Center .....	127
General Quality Criteria .....	127
Background Information Related to Site Evaluation .....	128
Analysis of Design Storms .....	128
Analyses Using Long-Term Rainfall Records.....	130
Design Storm Runs Using DETPOND.....	132
Site Photographs .....	133
The Use of DETPOND to Evaluate Wet Detention Pond for Minneapolis-St. Paul Airport.....	135
Long-Term Rain and Runoff Analyses for Minneapolis .....	135
Estimated Performance of Minneapolis-St. Paul International Airport Pond Design.....	137
Bypass of Excessive Flows around Pond .....	142
Short-Circuiting Factor Effects.....	143
Sizing and Performance of Airport Wet Detention Pond Based on Simple Design Criteria .....	146
Suggested Pond Modifications to Enhance Performance .....	149
Special Issues Associated with Wet Detention Ponds at Airports .....	149

DETPOND Input File for Proposed Minneapolis Airport Wet Detention Pond.....	150
DETPOND Output File for Proposed Minneapolis-St. Paul International Airport Wet Detention Pond (1952 – 1989).....	151
Design Suggestions for In-Receiving Water Detention.....	151
Retro-fit Examples for Providing Water Quality Benefits in Existing Dry Detention Ponds.....	155
Evaluation and Recommended Modifications to a Small Dry Stormwater Detention Pond.....	155
Background Information Related to Site Evaluation.....	157
Analysis of Design Storms.....	157
Analysis Using Actual Long-Term Rainfall Records.....	159
Design Storm Runs Using DETPOND.....	162
Photographs of the Dry Detention Pond at the Stonecrest Apartments.....	163
Retrofit of Dry Detention Pond in Sunnyvale, CA.....	165
Site Description.....	165
Treatment Concepts and Retrofitting Objectives.....	166
Description of Sunnyvale Retrofit Activities.....	166
Problems Encountered.....	167
Monitoring Program.....	167
Flooding Analysis, Storm Hydrology, Water Quality and Sediment Monitoring Results.....	168
Cost Effectiveness Evaluation.....	171
Conclusions.....	172
Retrofit Case Examples from the Center for Watershed Protection (Claytor 1998).....	173
Example of Retrofitting an Existing Stormwater Detention Facility, Wheaton Branch, Montgomery County, Maryland.....	173
Example of a Retrofit in a Highway Right-of-Way, Bear Gutter Creek, Westchester County, New York.....	175
Conclusions.....	176
References.....	177
Appendix A: User Guide for DETPOND.....	192
Example Design Calculations and Evaluation Using DETPOND.....	192
Steps in Entering Data for Evaluation in DETPOND.....	197
Example 1: Create a Rain File for Use in DETPOND.....	209
Example 2: Edit the Rain File Created in Example 1.....	210
Example 3: Create a Rain File from CD ROM Data.....	211
Example 4: Stochastically Generate a Rain File.....	212
Example 5: Create a Particle Size Distribution File.....	213

## Introduction

This chapter discusses one of the most often used and most effective stormwater control practice: wet detention ponds. There are many stormwater control practices, but all are not suitable in every situation. It is important to understand which controls are suitable for the site conditions and can also achieve the required goals. This will assist in the realistic evaluation for each practice of: the technical feasibility, implementation costs, and long-term maintenance requirements and costs. It is also important to appreciate that the reliability and performance of many of these controls have not been well established, with some still in the development stage. This is not to say that emerging controls cannot be effective, however, they do not have a large amount of historical data on which to base designs or to be confident that performance criteria will be met under the local conditions. The most promising and best understood stormwater control practices are wet detention ponds. Less reliable in terms of predicting performance, but showing promise, are stormwater filters, wetlands, and percolation basins (Roesner, *et al.* 1989). Grass swales also have shown great promise during the EPA's Nationwide Urban Runoff Program (NURP) (EPA 1983) and other research projects. During the last 10 to 20 years, much additional experience has been gained with many stormwater practices, especially source controls and stream restoration efforts. An effective stormwater management program likely must contain elements of many control practices to be most cost-effective. The combinations of practices that are most efficient for a specific area must be selected based on many site specific conditions and local objectives. In almost all cases, however, the use of wet detention ponds is an important stormwater control that should be given serious consideration.

Wet detention ponds are also one of the most robust stormwater control practices available. Although a good maintenance program is necessary to ensure the best performance and minimize associated problems, many stormwater ponds have functioned well with minimal maintenance. In addition, as long as certain design guidelines are followed, many design details that are worthwhile to consider do not create critical problems if incorrectly implemented. Finally, it is possible to retro-fit stormwater ponds and correct many of these problems as experience dictates. These robust attributes are rare for most stormwater control practices. As an example, a study of 11 types of stormwater quality and quantity control practices used in Prince George's County, Maryland (Metropolitan Washington Council of Governments 1992) was conducted to examine their performance and longevity. This report concluded that several types of the stormwater control practices had either failed or were not performing as well as intended. Generally, wet ponds, artificial marshes, sand filters, and infiltration trenches achieved moderate to high levels of removal for both particulate and soluble pollutants. Only wet ponds and artificial marshes were found to function for a relatively long time without frequent maintenance. Control practices which were found to perform poorly included infiltration basins, porous pavements, grass filters, swales, smaller "pocket" wetlands, extended detention dry ponds, and oil/grit separators. Infiltration stormwater controls had high failure rates which could often be attributed to poor initial site selection and/or lack of proper maintenance. The poor performance of some of the controls was likely a function of poor design, improper installation, inadequate maintenance, and/or unsuitable placement of the control. Greater attention to these details would probably reduce the failure rate of these practices. The wet ponds and artificial marshes were much more robust and functioned adequately under a wider range of marginal conditions.

The majority of stormwater treatment practices are most effective for the removal of particulate forms of pollutants only, especially the settleable solids fraction. Removal of dissolved, or colloidal, pollutants is minimal and therefore pollution prevention or control at the sources offers a more effective way to control the dissolved pollutants. Fortunately, most toxic stormwater pollutants (heavy metals and organic compounds) are mostly associated with stormwater particulates (Pitt, *et al.* 1995). Therefore, the removal of the solids will also remove much of the pollutants of interest. Notable exceptions of potential concern include: nitrates, chlorides, zinc, pathogens, 1,3-dichlorobenzene, fluoranthene, and pyrene. Stormwater ponds mostly utilize sedimentation as the main pollutant removal mechanism. However, chemical and biological mechanisms are also available, especially when the pond is appropriately planted with wetland vegetation. Stormwater ponds, while costly, also generally add substantial value to adjacent property, if designed and maintained well. The following are general conclusions pertaining to stormwater detention facilities.

### ***Expected Detention Pond Performance***

- Dry ponds have little documented direct water quality benefits due to scouring of bottom sediments. Decreased receiving water velocities will decrease receiving water bank erosion and will improve aquatic habitat, however.
- Wet ponds have been extensively monitored under a wide variety of conditions. If well designed and properly maintained, suspended solids removals of 70 to 90% can be obtained. BOD<sub>5</sub> and COD removals of about 70%, nutrient removals of about 60 to 70%, and heavy metal removals of about 60 to 95% can also be obtained. Limited bacteria control (maybe up to 50%) can be expected in the absence of disinfection. Wet ponds can also be designed to obtain significant flood control benefits.

### ***Potential Detention Pond Problems***

- Wet ponds can require about three to six years to obtain an ecological balance. During the initial unstable period, excessive algal growths, fish kills, and nuisance odors may occur.
- Wet ponds can have poor water quality and water contact recreation and consumptive fishing should be discouraged.
- Careful watershed-wide planning is needed to insure composite flood control benefits from many ponds in a watershed.

### ***Wet Detention Pond Design Guidelines to Minimize Potential Problems***

- Keep pond shape simple to encourage good water circulation. The length should be about three to five times the width for maximum detention efficiency and the inlets and outlets need to be widely spaced to minimize short-circuiting.
- Need at least three and preferably six feet of permanent standing water over most of the pond to protect sediments from scouring, to decrease light penetration (to minimize rooted aquatic plant growths), and to increase winter survival of fish.
- Increase flushing during dry weather, possibly with groundwater, to improve water quality. Reduce contaminated baseflows from entering the pond through source controls.
- Correct pond side slopes are very important to improve safety and aesthetics and to minimize mosquito problems and excessive rooted plant growths. An underwater shelf near the pond edge needs to be planted with rooted aquatic plants to prevent children's access to deep water, to improve pond aesthetics, to increase pollutant removals through biochemical processes, and to improve aquatic habitat. If waterfowl are desired users of the pond, then no more than one-half of the pond perimeter should be heavily planted. The following general dimensions for pond side slopes are suggested:

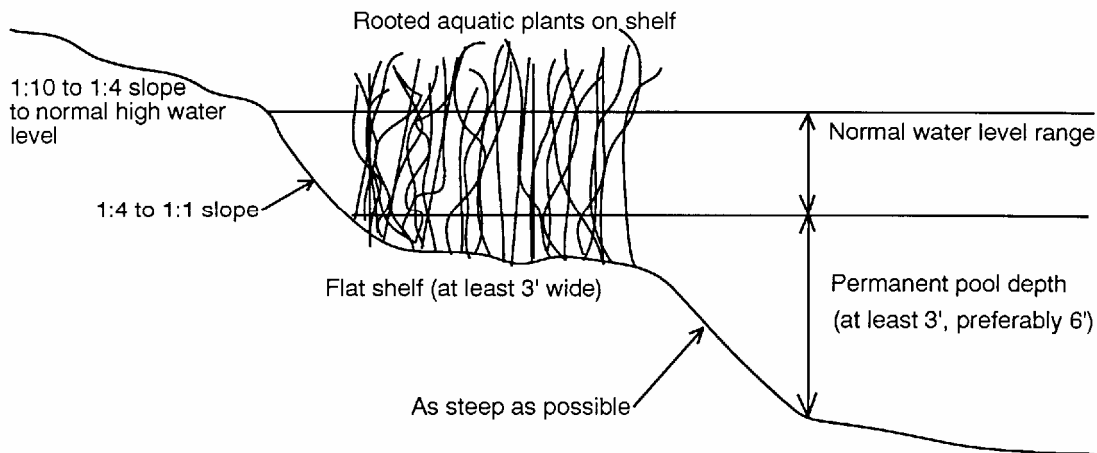

- Outlet structures should be designed for low outflows during low pond depths to maximize particulate retention. Place underwater dams or deeper sediment trapping forebays near pond inlets to decrease required dredging areas. Provide a drain to completely de-water the pond for easier maintenance.
- Protect the inlet and outlet areas from scour erosion and cover the inlets and outlets with appropriate safety gratings. Provide an adequate emergency spillway. Minimize water elevation changes to discourage mosquito problems.

### ***Required Stormwater Detention Pond Maintenance***

- If the pond does not require any maintenance, it is not producing very many water quality benefits. Ponds need to be periodically dredged to remove contaminated bottom sediments.
- Plan extra pond depth for sacrificial volume to lengthen dredging intervals (approximately one inch per year, much more in forebays). Also plan for heavy equipment access to pond edges.
- Remove excessive algae to prevent decomposition and nutrient cycling and associated nuisance conditions.

### ***Basic Wet Detention Pond Design Guidelines***

- Engineering design guidelines (covering such things as foundations, fill materials, embankments, gratings, anti-seep collars, and emergency spillway construction), such as published by the U.S. Natural Resources Conservation Service and the Corps of Engineers must be followed.

- Pond size is dictated mostly by desired particle control and water outflow rate. The following table is an estimate of pond surface requirements for different land uses and conditions. Five  $\mu\text{m}$  control will remove all particles greater than five  $\mu\text{m}$  from the runoff water and corresponds to about 90% suspended solids reductions in urban runoff. Twenty  $\mu\text{m}$  control will result in about 65% suspended solids reductions.

Percent of drainage area required as pond for:

<u>Land Use</u>	<u>5 <math>\mu\text{m}</math> control</u>	<u>20 <math>\mu\text{m}</math> control</u>
Totally paved areas	3.0 percent	1.1 percent
Freeways	2.8	1.0
Industrial areas	2.0	0.8
Commercial areas	1.7	0.6
Institutional areas	1.7	0.6
Residential areas	0.8	0.3
Open space areas	0.6	0.2
Construction sites	1.5	0.5

### ***Wet Detention Pond Costs***

- Initial wet detention pond construction costs are roughly estimated to be about \$40,000 per acre of pond surface (excluding land costs).

- Maintenance costs are estimated to be about \$1500 per pond surface acre per year.

### ***Pond Size Calculation***

- The following table shows the minimum pond surface area (acres) required for different freeboard elevations above the invert of 60 degree and 90 degree V-notch weirs, for both five and twenty  $\mu\text{m}$  particle control:

Head (feet)	Discharge (cfs)	60° V-notch weir		90° V-notch weir		
		Min. surface acres for:		Discharge (cfs)	Min. surface acres for:	
		5 $\mu\text{m}$	20 $\mu\text{m}$		5 $\mu\text{m}$	20 $\mu\text{m}$
0.5	0.25	0.044	0.004	0.45	0.08	0.006
1	1.4	0.25	0.02	2.4	0.42	0.03
1.5	3.9	0.69	0.06	6.7	1.2	0.1
2	8.0	1.4	0.11	14	2.5	0.2
3	22	3.9	0.32	40	7.1	0.6
4	45	7.9	0.65	81	14	1.2

A discussion of wet detention pond design procedures must include three very important publications that all stormwater managers should have. Tom Schueler's *Controlling Urban Runoff: A Practical Manual for Planning and Designing Urban Best Management Practices* (1987) includes many alternative wet pond designs for various locations and conditions. *Watershed Protection Techniques* is a periodical published by Schueler at the Center for Watershed Protection (Ellicott City, Maryland) and includes many summaries of current stormwater management research, including new developing design procedures and performance data for detention ponds. In addition, Peter Stahre's and Ben Urbonas's book on *Stormwater Detention for Drainage, Water Quality and CSO Management* (1990) includes in-depth discussions on many detention pond design and operational issues.

## **Background**

Detention ponds are probably the most common management practice for the control of stormwater sediment. If properly designed, constructed, and maintained, they can be very effective in controlling a wide range of pollutants and peak runoff flow rates. In an early 1980 survey of cities in the U.S. and Canada, the American Public Works Association found more than 2,000 wet ponds, more than 6,000 dry ponds, more than 3,000 parking lot multi-use detention areas, and more than 500 rooftop storage facilities (Smith 1982). About half of the wet detention ponds were publicly owned. In some areas of the U.S., detention ponds have been required for some time and are therefore much more numerous than elsewhere. In Montgomery County, Maryland, as an example, detention ponds were first required in 1971, with more than 100 facilities planned during that first year, and about 50 actually constructed. By 1978, more than 500 detention facilities had been constructed in Montgomery County alone (Williams 1982). In DuPage County, Illinois, near Chicago, more than 900 stormwater detention facilities (some natural) receive urban runoff (McComas and Sefton 1985).

There is probably more information concerning the design and performance of detention ponds in the literature than for any other stormwater control device. Wet detention ponds are also a very robust method for reducing stormwater pollutants. They typically show significant pollutant reductions as long as a few basic design-related attributes are met (most important being size). Many details are available to enhance performance, and safety, that should be followed. Many processes are responsible for the pollutant removals observed in wet detention ponds. Physical sedimentation is the most significant removal mechanism. However, biological and chemical processes can also contribute important pollutant reductions. The extensive use of aquatic plants, in a controlled manner, can provide additional pollutant removals. Magmedov, *et al.* (1996), for example, report on the use of wetlands for treatment of stormwater runoff in the UK and in the Ukraine, including design guidelines. Wet detention ponds also are suitable for enhancement with chemical and advanced physical processes. Lamella separators, air floatation, filtration, and UV disinfection are examples of treatment enhancements being investigated in France (Bernard, *et al.* 1996; Delporte 1996).

Ellis (1993) describes design guidelines for a reed bed wetland for the treatment of stormwater. These are compact control practices that have little standing water. Most of the removal of pollutants occurs in the root zone of the selected wetland plants, with pretreatment provided by a grit chamber and possibly a grass filter. A small micropool can also be used after the reed bed. It is expected that these wetlands would provide from 50 to 90% reductions of suspended solids, and up to 90% removal of heavy metals.

Little information has been provided in the literature on the performance of artificial wetlands in cold climates for stormwater treatment. Dormant plants provide ineffective mechanisms for pollutant removal, plus scour of previously retained pollutants may increase during periods of dormancy. It is recommended that stormwater wetlands be used as polishing treatment devices, after pretreatment with more robust devices (such as wet detention ponds), in areas having severe weather. Flows should also be diverted around wetland treatment systems whenever the plants are dormant, except for necessary flows to sustain natural moisture conditions. Harvesting of aquatic plants is also probably needed in wetland treatment systems. Decomposition of plants readily release nutrients and other organic material that may degrade water quality.

### ***Multiple Benefits of Detention Facilities***

The most common multiple benefit of detention facilities built for water quality improvements is flood control. If appropriately designed, wet detention ponds can provide significant peak flow rate reductions. Ponds by themselves provide little runoff volume reductions, but can be designed in conjunction with infiltration devices to provide water quality in addition to peak flow rate and water volume reduction benefits. In order to provide flood control benefits, substantial freeboard storage above the normal wet pond elevation must be provided. This has been commonly done in open space land uses such as parks and golf courses where periodic short-term flooding does not detract from the other uses of the land.

Many people enjoy wetlands (including wet detention ponds) in urban settings. Adams, *et al.* (1982) reports a typical comment from a resident living near a wet detention pond in Columbia, Maryland: "...now that they've matured, we're reaping rewards from all the wildlife using the ponds." Numerous ducks, herons, egrets, songbirds, mammals, and amphibians have been observed and highly prized by residents living near these small artificial

wetlands. Establishing natural aquatic vegetation (rooted macrophytes) on the shallow shelf edges of the ponds make them more attractive to wildlife and enhances their beauty.

Fishing is also popular in many wet detention facilities, especially by children, although fish consumption should usually be discouraged due to the possibility of accumulations of toxic substances. Recreational fishing in wet detention facilities using catch and release is currently enjoyed by many.

The integration of properly designed, constructed, and maintained wet detention ponds into parks and linear green (and blue) belts can provide substantial community benefits, even if the water quality in the ponds is less than “good” (Jones and Jones 1982). Flood control, non-contact recreation, non-consumptive fishing, education, and aesthetics benefits have all been achieved at many wet detention ponds.

### ***Dry Ponds***

Dry ponds have been extensively used throughout the U.S. and other countries (EPA 1983). These ponds have been constructed to reduce peak runoff rates (peak shaving), with typically little consideration given to runoff quality improvement. Their main purpose has therefore been in flood control by reducing flows and water elevations in the receiving waters. These flow reductions can also improve the aquatic habitat by reducing flushing of fish and other organisms from urban creeks (Pitt and Bissonnette 1984). Flow reductions also reduce downstream channel bank erosion and bottom scour. The use of many dry ponds in a watershed, without regard to their accumulative effect, can actually increase downstream flooding or channel scour problems (McCuen, *et al.* 1984). The delayed discharge of a mass of water from a dry pond may be superimposed on a more critical portion of the receiving water hydrograph.

Because these ponds are normally dry and only contain water for relatively short periods of time, they can be constructed as part of parking lots, athletic fields, tennis courts and other multi-use areas. Their outlets are designed to transmit all flows up to a specific design flow rate, after which excess flows are temporarily backed-up. In many cases, they only contain water during a few rains each year.

Several dry detention ponds were examined as part of the NURP program, with monitored pollutant removals ranging from insignificant to quite poor (EPA 1983). Sedimentation may occur in dry ponds, but only during the major storms when flows are retained in the pond. The deposited material must be removed after each treated rain, or it can easily be resuspended by later rains and washed into the receiving waters. Adler (1981) found that new sediment deposits have little cohesion and without removal as part of a maintenance program, or without several feet of overlaying water, bottom scour is probable. Because of the poor documented stormwater pollutant control effectiveness of dry detention ponds, they cannot, by themselves, be recommended as viable water quality control measures. However, they can be very effective when used in conjunction with other stormwater control practices (such as between a wet detention pond and an infiltration or grass filter area).

### ***Wet Detention Ponds***

Wet detention ponds maintain several feet of water in a permanent pool. The runoff water is detained for varying periods of time, depending on the pond detention volume and the storm runoff flow rate and duration. Detention times (residence) can vary from several minutes for small ponds receiving high flows to many days for large ponds receiving relatively small flows. Monitored performance of wet ponds during the NURP program ranged from poor to excellent, generally depending on the size of the detention pond relative to the watershed area served and storm characteristics (EPA 1983). Sedimentation is the main pollutant removal process, but biological processes can also substantially reduce concentrations of soluble nutrients by converting them into algae and by providing substrate for beneficial bacteria. If the algae is removed from the detention pond, nutrient discharges to the receiving waters can be reduced. If algae is not harvested from the ponds, dead algae can be decomposed back into soluble nutrient forms (and exert biochemical oxygen demand) either in the detention pond or in the receiving water. Wet ponds can be very effective in the control of stormwater runoff flows and pollutants, but must be carefully designed and maintained to prevent nuisance conditions from developing.



### ***Extended Detention (Combination) Ponds***

Extended detention, or combination wet/dry ponds, are normally dry, but have special outlets that cause the slow release of impounded water. They are therefore not as conveniently used for other uses, such as parking lots. Outlet modifications can be easily made to existing dry ponds to make them into extended detention ponds and significantly improve their stormwater pollutant control effectiveness (EPA 1983). Since they are normally dry and lack a protective water cover over the deposited sediment, they must be frequently maintained to remove accumulated sediment before a flushing rain occurs. Biological activity is restricted, reducing the potential of high nutrient removals, but they also have reduced potentials for nuisance algal growths and mosquito production. Depending on their design, extended detention ponds may behave as artificial wetlands, grass filters or percolation ponds, with much greater pollutant removal benefits, compared to dry ponds.

### ***Roof Storage***

Specialized detention “ponds” include roof storage of water. These behave like dry ponds, as permanent standing water is not desirable. Roof water runoff rates can be substantially reduced by temporary detaining roof water. Very few particulates are found in roof runoff waters (Pitt and McLean 1986), so rooftop particulate sedimentation is not very important. The reduction of roof runoff flow rates can significantly reduce erosion near downspouts and “slower” roof runoff can be more easily treated by infiltration devices. Plastic rings with holes, or gravel, can be placed around roof drain inlets to slow water runoff from roofs. Water depths of two or three inches can be safely held on most roofs, with roof runoff rates reduced to about 0.6 cubic feet per second per acre of roof (Ontario 1984).

Rospond (1976) studied the effects of roof storage on site hydrology and found it to be very effective in reducing peak flows. He found that substantial cost savings resulted because of reduced pipe savings, even when considering the extra structural costs associated with strengthening the roofing systems. Controlling roof runoff rates also allows significant savings when infiltration devices are also needed. By storing runoff on the roof, infiltration trenches to store runoff from periods of peak rain intensities are not needed. Simple surface percolation areas created by site grading and landscaping may be sufficient for most cases. Substantial cost savings would then be realized because excavation of trenches and purchased filter fabric and rock fill would not be needed. Long term maintenance of the infiltration area would also be less of a problem with a surface percolation area as compared with an infiltration trench system.

### ***Up-Sized Pipes***

Enlarged pipe sections have been used to create in-line detention within the storm drainage system. These large pipe sections slow the water velocity and provide a sump for sediment. They remove suspended sediment through sedimentation and bed load sediment by trapping. An up-sized pipe section was monitored in Lansing, Michigan as part of a NURP project (Luzkow, *et al.* 1981). This device had a 54” inlet pipe entering a 144’ section of 96” up-sized pipe. A 48” outlet pipe was used. All pipes had their crowns aligned, were made of reinforced concrete, and were at slightly less than a 1% slope. The performance of this device was variable, but much larger in-line systems (such as the deep tunnels in Chicago and Milwaukee for the control of combined sewer overflows) can be expected to have much more consistent and better performance. The required maintenance of underground devices that collect large amounts of sediment may be difficult, however. The Lansing, Michigan, tests of the up-sized pipes found particulate residue removals of about 30 to 50 percent. Large quantities of trapped bed load were also retained, but BOD<sub>5</sub> and nutrient removals were quite low (Luzkow, *et al.* 1981).

### ***Underground Rock-Filled Detention***

Another form of underground sedimentation, rock filled detention reservoirs, has been used in very high density commercial areas in the New York City and Boston areas (Heimbuch 1981). These are created under buildings during building excavation and are designed for peak flow reduction and not for pollutant removal. Collected stormwater is distributed through finger type perforated galleries that are rock filled. The stormwater is detained underground and slowly released through a control orifice. These devices are most suitable where excessive rock is produced during excavation. Even though the volumes of the galleries are about three times the volumes required for cisterns that are not rock filled, the rock filled system is substantially less expensive because of the structural support provided and the unfinished walls. Maintenance to remove deposited sediment is not possible, but the distribution

system minimizes clogging. Excess volume must be provided for sediment storage for the life of the project. Sediment removal performance may possibly decrease and sediment scour may increase with time.

### ***Use with Other Controls***

Detention facilities can be easily used in conjunction with other stormwater control devices. Upland infiltration can be used to treat parking lot and roof runoff, substantially reducing the size of “downstream” detention facilities. Even with source area controls, detention facilities can be very important in industrial areas to help treat dry weather urban runoff. A series of control devices has been described by Hawley, *et al.* (1981) that uses a preliminary sedimentation trap, followed by a grass filter strip and a wet detention pond. This arrangement would substantially decrease sedimentation (and required maintenance) and substantially reduce nuisance conditions in the detention facility.

### ***Examples of Detention Pond Performance***

There have been many studies that have examined detention pond performance. They included laboratory settling column tests, pilot scale laboratory experiments, and full scale field experiments. Colston (1974), during laboratory tests, found that fifteen minutes of quiescent settling removed about 80 percent of the suspended solids, 60 percent of the COD and 50 percent of turbidity from urban runoff. Davis (1979) found significant reductions in indicator and pathogenic bacteria with plain sedimentation. Dalrymde, *et al.* (1979), also found that one hour of settling reduced suspended solids concentrations by 80 to 90 percent. Grizzard, *et al.* (1986) described a series of settling column studies which examined pollutant concentration changes with time for several types of runoff samples having various residue concentrations. This information related quite well with their limited field observations. The samples having high concentrations of suspended solids experienced very high percentage removals in short time periods (about 85% removal after only two hours). Samples having low initial suspended solids concentrations required much longer settling times to achieve the same percentage removals (about 48 hours of settling for 85% removal). Low particulate pollutant concentrations for all samples however, were found after about 10 to 15 hours of settling.

### ***Chemical Assisted Sedimentation***

Chemical addition has been used for many years in water treatment, and in lake management. More recently, full-scale implementations of chemical assisted settling has been used for the treatment of stormwater in wet detention ponds or at outfalls into small urban lakes. The chemicals tested and used include alum (generally a complex of aluminum and sulfate), ferric chloride, and aluminum chloride compounds, plus various coagulant aids.

The addition of alum in Colston’s (1974) tests further increased the reduction of particulate residue, COD, and turbidity to about 85 to 97 percent. Gietz (1981), in a series of laboratory tests in Ontario, found that an alum dosage of 4 to 6 mg/L was the most effective for highly polluted runoff. Over-dosages of alum and ferric chloride generally gave poor results. He found that it was difficult to add the correct dosage of coagulant because of the changing pollutant concentrations in the runoff. Low flow velocities also reduced mixing effectiveness and may require mechanical assistance. The flocs that were formed with the coagulants were easily disturbed by runoff turbulence.

Kronis (1982), in a series of Ontario bench and pilot scale tests, found that disinfection of stormwater with NaOCl at 5 mg/L available chlorine reduced fecal coliform populations to less than 10 organisms per 100 ml. He identified alum dosages of 30 mg/L as a preferred flocculant, with 10 to 30 percent increases in removals of particulate residue, BOD<sub>5</sub>, COD, and total phosphorus as compared to plain sedimentation. However, chemical assisted settling generally produced moderate and erratic reductions in bacteria populations. Disinfection in wet detention ponds may be expensive, but it may be the only feasible method of significantly reducing bacteria populations in areas with serious bacteria problems.

Heinzmann (1993) described the development of a coagulation and flocculation treatment procedure for stormwater in Berlin. He found that because the stormwater was weakly buffered and was very soft, a polyaluminum chloride, with a cationic coagulant aid (polyacrylamid), was most suitable. A constant dosage of 0.06 mmol/L (as Al) was used, resulting in pH levels always greater than 6. The constant dosage was possible because the pH and buffering capacity of the stormwater was relatively constant during storms. He found that the best enhanced stormwater treatment process used coagulation and flocculation in a pipe designed for both microfloc and macrofloc formation, and final separation by filtration. The filtration was much better than the one hour sedimentation typically used in

Berlin sedimentation tanks. He did find that a six minute flocculation time was sufficient before filtration. He found significant removals of phosphorus (<0.2 mg/L), organic compounds (including PCB and PAHs), solids (<5 mg/L), lead and copper. However, very poor removal of zinc was noted, and pollution prevention (decreased use of galvanized metals) was recommended. In the one-hour sedimentation tanks, without any chemical addition, the phosphorus (about 0.5 mg/L) and solids (about 50 mg/L) effluent concentrations were not nearly as low. The costs for this enhanced treatment (7 to 10 DM/m<sup>3</sup> in 1990) was about 10 to 40% higher than with the ordinary one-hour sedimentation tanks alone.

Pitt and Dunkers (1992 and 1995a) described a full-scale stormwater treatment plant, using the Karl Dunkers' system for treatment of separate stormwater and lake water. This system has been operating since 1981 in Lake Rönningesjön, near Stockholm, Sweden. The treatment facility uses ferric chloride and polymer precipitation and crossflow lamella clarifiers for the removal of phosphorus. Excess flows are temporarily stored before treatment inside an in-lake flow balancing tank (the Flow Balancing Method, or FBM). The stored excess stormwater is then pumped from the flow balancing storage tanks to the treatment facility during dry weather. The overall phosphorus removal rate for the 11 years from 1981 through 1991 was about 17 kg/year. About 40% of the phosphorus removal occurred in the FBM from sedimentation processes, while the remaining occurred in the chemical treatment facility. This phosphorus removal would theoretically cause a reduction in phosphorus concentrations of about 10 µg/L per year in the lake, or a total phosphorus reduction of about 100 µg/L during the data period since the treatment system began operation. About 70% of this phosphorus removal was associated with the treatment of stormwater, while about 30% was associated with the treatment of lake water. The lake phosphorus concentration improvements averaged about 50 µg/L. This was only about one-half of the theoretical improvement, probably because of sediment-water interchange of phosphorus, or other unmeasured phosphorus sources.

The 1996 NALMS (North American Lakes Management Society) conference in Minneapolis/St. Paul included several presentations describing the use of alum for stormwater treatment. Harper and Herr (1996) describe the historical use of alum to treat stormwater entering Lake Ella in Tallahassee, FL, which began in 1986. A liquid slurry of alum is injected into the major storm drainage entering the lake, on a flow-weighted basis during rains. The alum forms precipitates with phosphorus, suspended solids, and heavy metals, which then settle in the lake. This treatment system resulted in immediate and substantial improvements to Lake Ella water quality. There are currently 23 alum stormwater treatment systems in Florida. Harper and Herr (1996) report that alum treatment of stormwater has consistently achieved 90% reductions in total phosphorus, 50 to 70% reductions in total nitrogen, 50 to 90% reductions in heavy metals, and >99% reductions in fecal coliform bacteria. The precipitates of the phosphorus and heavy metals have been shown to be extremely stable over a wide range of dissolved oxygen and pH conditions.

Herr and Harper (1996) also reported on a very large alum project at Lake Maggiore in St. Petersburg, FL. This 156 ha lake receives stormwater from a 927 ha watershed. Water quality problems were noted as early as the 1950s that included fish kills, algal blooms, nuisance macrophyte algal growths, and high bacteria levels. An environmental assessment determined that an 80% reduction in the annual phosphorus discharges from the stormwater and baseflow would result in an acceptable trophic status for the lake. Five alum treatment plants were then designed and will be operational in August 1997, comprising the largest alum stormwater treatment system ever built.

An alum pilot-scale treatment system for stormwater, located in Minnesota, was described by Kloiber and Brezonik (1996). This system injected 1 mg/L (as Al) alum into a storm sewer at a pumping station just upstream of a 1.2 acre wet detention pond. The few minutes travel time between injection and the pond allowed 75 to 80% reductions in soluble reactive phosphorus. However, the pond retained only 40% of the added aluminum, increasing to 70% when a coagulant aid was used. The lowest total aluminum concentration in the pond effluent was 0.26 mg/L, still exceeding the water quality standard. They concluded that closer evaluations of the toxicity and bioavailability of the aluminum associated with alum stormwater treatment is needed. During treatability tests of stormwater from critical source areas, Pitt, *et al.* (1995) found that alum addition significantly increased the toxicity of the water (as indicated using the Microtox screening procedure).

Pitt is currently conducting a series of chemical addition treatability tests for stormwater. He is examining alum, ferric chloride, and ferric sulfate (all with and without organic polymers), and organic polymers alone. He is also testing the benefits of adding a microsand (75 to 150 µm) as a coagulant aid. Preliminary findings indicate that ferric

chloride with the microsand is the most effective chemical for treating stormwater. The concentrations of the ferric chloride are in the range of 30 to 80 mg/L, and the microsand is added to produce a turbidity of about 200 NTU. Heavy metals (copper, lead, and zinc, in both particulate and filterable forms) and toxicants (as indicated by the Microtox™ screening test) removals have been greater than 80%, with many tests greater than 95%. Phosphates are also significantly reduced (by about 50%). Alum added toxicity (possibly through zinc contamination in the alum, or by the dissolved aluminum) and many of the polymers also added COD and toxicity. It is not yet clear how sensitive dosage control will have to be in order to provide acceptable levels of heavy metal control. Figures 1 through 6 show typical heavy metal removals for several chemical addition tests.

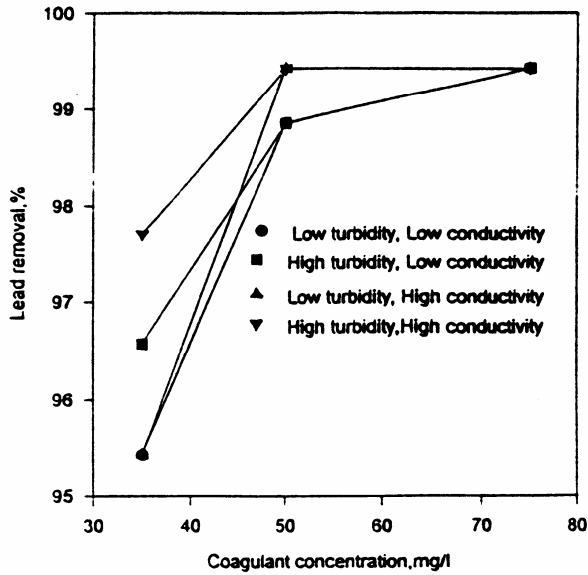

Figure 1. Lead removal using ferric chloride.

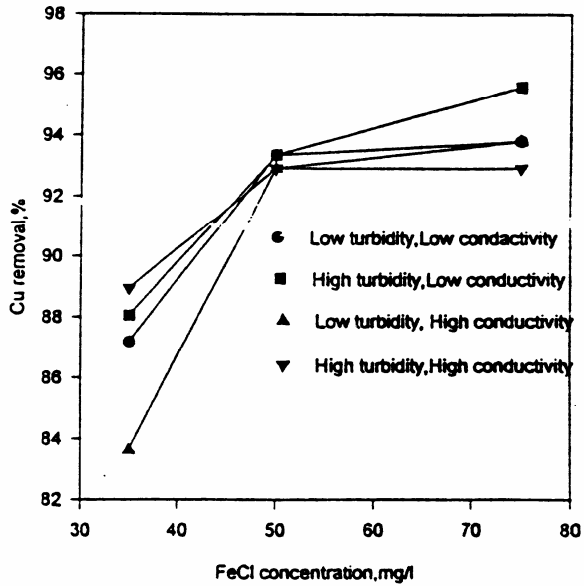

Figure 2. Copper removal using ferric chloride.

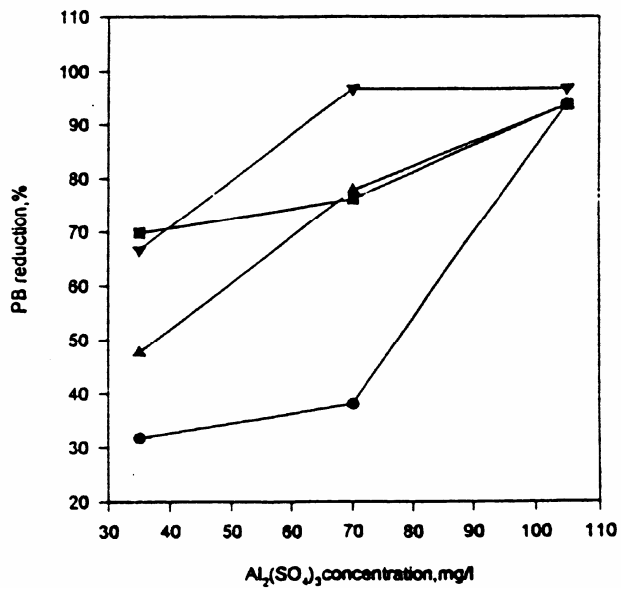

Figure 3. Lead removal using alum ( $Al_2(SO_4)_3$ )

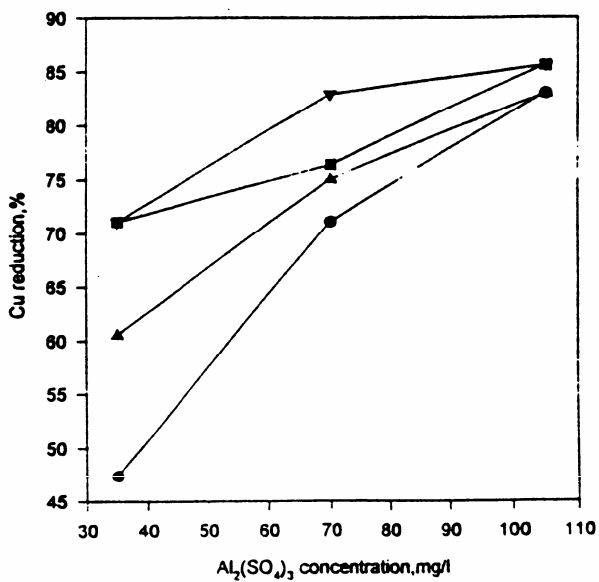

Figure 4. Copper removal using alum ( $Al_2(SO_4)_3$ )

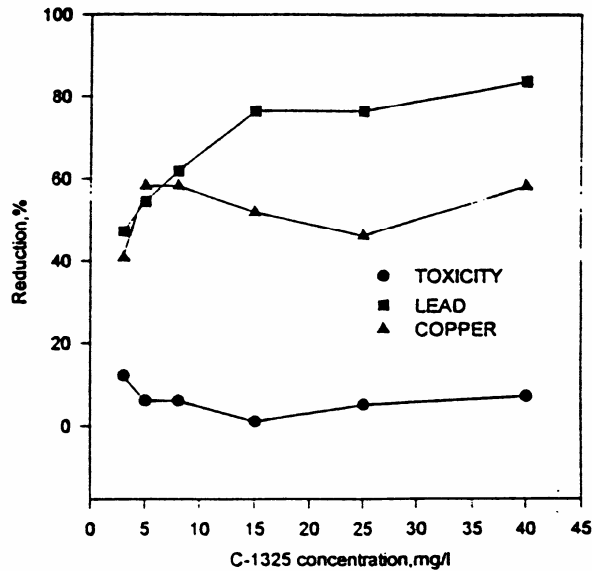

Figure 5. Metals and toxicant reductions using organic polymer (C-1325).

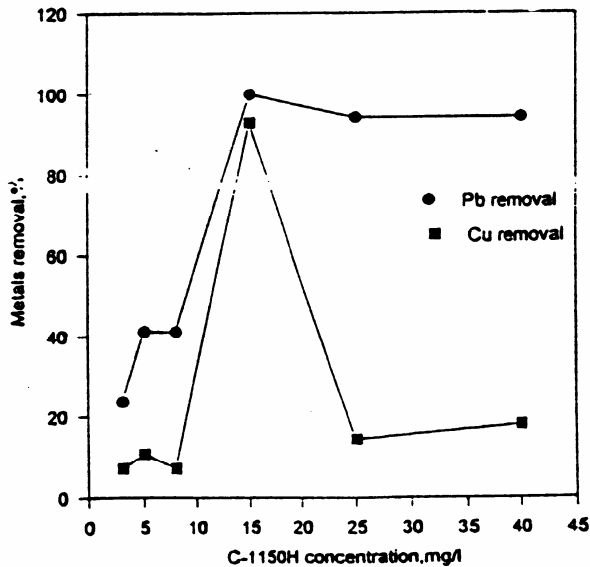

Figure 6. Metals removed using organic polymer (C-1150H).

### Full-scale Demonstrations

The use of detention ponds for both water quality and quantity benefits is relatively new. Wet pond stormwater quality benefits have been commonly reported in the literature since the 1970s, while the water quality benefits of dry detention ponds have only recently been adequately described (Hall 1990).

The Nationwide Urban Runoff Program included full-scale monitoring of nine wet detention ponds (EPA 1983). The Lansing project included two up-sized pipes, plus a larger detention pond. The NURP project located in Glen Ellyn (west of Chicago) monitored a small lake, the largest pond monitored during the NURP program. Ann Arbor, Michigan, monitoring included three detention ponds, Long Island, New York, studied one pond, while the

Washington D.C. project included one pond. About 150 storms were completely monitored at these ponds, and the performances ranged from negative removals for the smallest up-sized pipe installation, to more than 90 percent removal of suspended solids at the largest wet ponds. The best wet detention ponds also reported BOD5 and COD removals of about 70 percent, nutrient removals of about 60 to 70 percent, and heavy metal removals of about 60 to 95 percent.

The Lansing NURP project monitored a wet detention pond (Luzkow, *et al.* 1981). The monitored pond was located on a golf course (receiving urban runoff from an adjacent residential and commercial area). Suspended solids removals were about 70 percent for moderate rains (10 to 25 mm rains) while phosphorus removals were usually greater than 50 percent. Total Kjeldahl nitrogen removals ranged from about 30 to 50 percent. The removals of these pollutants increased with increasing storm size because of the larger quantities of pollutants carried by the larger storms. During small storms, most of the discharge water was displaced water from preceding storms which was still relatively polluted. For rains smaller than about 0.25 inches, the discharge pollutant yields were typically greater than the input yields for most of the pollutants.

Hey and Schaefer (1983), as part of a NURP project, reported substantial urban runoff improvements for a small Chicago area (Glen Ellyn) lake that was about ten percent of the residential area served. Lake monitoring indicated about 85 percent suspended solids removals, even with residence times substantially longer than the four hours reported to give 95 percent suspended solids removals during lab tests. They felt that flocculation was responsible for the differences between the lab tests and the observed field results. Total phosphorus removals were about 35 percent, while heavy metal (copper, lead, and zinc) removals were about 75 percent.

Two wet detention ponds near Toronto, Ontario, were monitored from 1977 through 1979 (Brydges and Robinson 1986). Lake Aquitaine is 1.9 ha in size and receives runoff from a 43 ha urban watershed. Observed pollutant reductions were about 70 to 90 percent for suspended solids, 25 to 60 percent for nitrogen, and about 80 percent for phosphorus. The much smaller Lake Wabukayne (0.8 ha) received runoff from a much larger urban area (186 ha). The smaller Lake Wabukayne experienced much smaller pollutant reductions: about 30 percent for suspended solids, less than 25 percent for nitrogen, and 10 to 30 percent for phosphorus.

Oliver, *et al.* (1981), monitored a small lake detention facility in Rolla, Missouri. Suspended solids yield reductions averaged about 88 percent, with 54 and 60 percent yield reductions for COD and total phosphorus. Organic nitrogen yields were reduced by about 22 percent.

Gietz (1983) studied a 1.3 ha wet detention pond serving a 60 ha urban watershed near Ottawa, Ontario. Batch operation of the pond resulted in substantial pollutant control improvements for particulate residue, bacteria, phosphorus, and nitrate nitrogen. Continuous operation gave slightly better performance for BOD5 and organic nitrogen. Suspended solids reductions were about 80 to 95 percent, BOD5 reductions were about 35 to 45 percent, bacteria was reduced by about 50 to 95 percent, phosphorus by about 70 to 85 percent, and organic nitrogen by about 45 to 50 percent.

Numerous additional detention pond performance studies have been conducted in the years since the Nationwide Urban Runoff Program. Yousef, *et al.* (1986) reported some long-term nutrient removal information for a detention pond in Florida having very long residence times and substantial algal and rooted aquatic plant growths. He found 80 to 90 percent removals of soluble nutrients due to plant uptake. Particulate nutrient removals, however, were quite poor (about ten percent). These particulate nutrient forms were mostly nitrogen and phosphorus that were tied up with the plant cells and not the particulate nutrient forms that were discharged to the pond with the runoff (Driscoll 1986). It is difficult to design a detention pond to obtain a desired net removal of nutrients (soluble plus particulate forms) because of the plant uptake and conversion of soluble forms to particulate cellular forms. If the plants are not removed from the detention pond, the particulate cellular nutrients will be released back into the water as more available (soluble) forms during periods of plant die-off. The role of aquatic plants in nutrient (and other pollutant) removals for cold climatic conditions is not well understood. Substantial releases of pollutants that had been "removed" by aquatic plants during the growing season when the plants die back in the fall is expected, resulting in substantially less removals than indicated by warm weather monitoring alone.

Hvitved-Jacobsen, *et al.* (1987) along with Martin and Miller (1987) described pollutant removal benefits of wet detention ponds. Niemczynowicz (1990) described stormwater detention pond practices in Sweden. Van Buren, *et al.* (1996) also reported on the performance of a on-stream pond located in Kingston, Ontario. They describe their monitoring activities and measures taken to enhance performance.

Hvitved-Jacobsen, *et al.* (1994) examined the most effective treatment systems for treating urban and highway runoff in Denmark. They concluded that wet detention ponds were the most efficient and suitable solution for the removal of most pollutants of concern from both highway and urban runoff. Denmark does not have any effluent standards and the acceptable pollutant discharges are therefore determined based on specific receiving water requirements. They concluded that CSO problems were causing acute receiving water effects (hydraulic problems, oxygen depletion, high bacterial pollution, etc.), requiring treatment designs based on design storm concepts. However, both urban and highway runoff were mostly causing accumulative (chronic) effects (associated with suspended solids, toxicants, and nutrient discharges) and treatment designs therefore need to be based on long-term pollutant mass discharge reductions. It was evident that relatively low concentrations of pollutants must be reduced, and that large volumes of water must be treated in a short time period. For these reasons, and for the specific pollutants of concern, they concluded that wet detention ponds were the most effective option, even though the first wet detention pond was only constructed in Denmark in 1989. Their recommended design was based on: detention pond volume (about 250 m<sup>3</sup> per effective hectare of drainage area), water depth, pond shape, use of plants (covering at least 30% of the water surface), and the use of a grit removal forebay. This pond design was evaluated using the computer program MOUSE/SAMBA for long-term simulations using Aalborg, Denmark, rains. The resulting mass removals using this design were excellent for suspended solids (80 to 90%) phosphorus (60 to 70%) and heavy metals (40 to 90%).

Mayer, *et al.* (1996) examined sediment and water quality conditions in four wet detention ponds in Toronto. They found that poor water circulation in the summer months between rains decreased the pond water quality, especially for dissolved oxygen and nutrients. Anaerobic conditions near the pond water-sediment interface in two of the ponds caused elevated ammonia concentrations. They felt that decomposition of nitrogenous organic matter (from terrestrial and aquatic plant debris) was the likely source of the ammonia. They also found prolific algal growths in the same two ponds in the summer, with chlorophyll a concentrations of about 30 µg/L. The chlorophyll a concentrations in the other two ponds were much lower, between about 3 and 10 µg/L.

Maxted and Shaver (1996) examined the biological and habitat characteristics downstream from several headwater wet detention ponds in Delaware to measure beneficial effects. They found that the ponds did not improve the habitat conditions or several benthic indices, compared to similar sites without ponds, when the watershed impervious cover exceeded about 20%. They stress that more research is needed examining other stream indicators, especially in less developed watersheds and in other parts of the country. They concluded that riparian zone protection, which is commonly overlooked in extensively developed watersheds, needs much more attention. The use of stormwater management practices apparently only is able to overcome part of the detrimental effects of development.

Stanley (1996) examined the pollution removal performance at a dry detention pond in Greenville, NC, during eight storms. The pond was 0.7 ha in size and the watershed was 81 ha of mostly medium density single family residential homes, with some multifamily units, and a short commercial strip. The observed reductions were low to moderate for suspended solids (42 to 83%), phosphate (-5 to 36%), nitrate nitrogen (-52 to 21%), ammonia nitrogen (-66 to 43%), copper (11 to 54%), lead (2 to 79%), and zinc (6 to 38%). Stanley also summarized the median concentration reductions at dry detention ponds studied by others, shown in Table 1. In all cases, the removals of the stormwater pollutants is substantially less than would occur at well designed and operated wet detention ponds. The resuspension of previously deposited sediment during subsequent rains was typically noted as the likely cause of these low removals. The conditions at the Greenville pond were observed three years after its construction. The most notable changes was that the pond bottom and interior banks of the perimeter dike were covered with weeds and many sapling trees (mostly willows), indicating that the interior areas have been too wet to permit mowing. The perforated riser was also partially clogged and some pooling was occurring near the pond outlet. It seemed that the dry pond was evolving into a wetlands. The monitoring activity was conducted a few months after the pond was constructed and was not affected by these changes. Stanley felt that the wetlands environment, with the woody



vegetation, if allowed to spread, could actually increase the pollutant trapping performance of the facility. With continued no maintenance, the dry pond will eventually turn into a wet pond, with a significant permanent pool. The pollutant retention capability would increase, at the expense of decreased hydraulic benefits and less flood protection than originally planned. Maintenance problems in dry ponds had also been commonly noted in earlier Maryland surveys.

**Table 1. Summary of Dry Detention Pond Pollutant Removal Capability (Stanley 1996).**

	Detention pond name and location						
	Lakeridge northern Virginia <sup>a</sup>	London northern Virginia <sup>b</sup>	Stedwick Montgomery Co., Md. <sup>c</sup>	Maple Run Austin, Tex. <sup>d</sup>	Oakhampton Baltimore, Md. <sup>e</sup>	Lawrence Kans. <sup>f</sup>	Greenville, N.C. <sup>g</sup>
Watershed, acres	88	11	34	28	17	12	200
Imperviousness, %						49	
Hours to drain after filling	1-2	<10	6-12	-9		6-16	75
Storms monitored	28	27	25	17		19	8
Removal efficiencies, %							
TSS	14	29	70	30	87	3	71
TP	20	40	13	18	26	19	14
PO <sub>4</sub> -P	-6				-12	0	26
TN	10	25	24	35			26
NO <sub>3</sub> -N	9			52	-10	20	-2
NH <sub>4</sub> -N				55	54	69	9
TOC				30		-3	10
POC							45
DOC							-6
Cu				31			26
Pb		39	62	29		66	55
Zn	-10	24	57	-38		65	26

Each study differs with respect to pond design, number of storms monitored, pollutant removal calculation techniques, and monitoring techniques. Therefore, exact comparisons cannot be made.

<sup>a</sup> MWCOG (1983); <sup>b</sup> OWML (1987); <sup>c</sup> Schueler and Helfrich (1988); <sup>d</sup> City of Austin, 1991 personal communication, cited in Schueler *et al.* (1992); <sup>e</sup> Baltimore Department of Public Works (1989); <sup>f</sup> Pope and Hess (1988); <sup>g</sup> this study.

The benefits of off-line stormwater detention ponds were examined by Nix and Durrans (1996). Off-line ponds (side-stream ponds) are designed so that only the peak portion of a stream flow is diverted to the pond (by an in-stream diversion structure). They are designed to reduce the peak flows from developed areas, with no direct water quality benefits, and are typically dry ponds. Off-line ponds are smaller (by as much as 20 to 50%) than on-line ponds (where the complete storm flow passes through the pond) for the same peak flow reductions. However, the outflow hydrographs from the two types of ponds are substantially different. The off-line ponds produce peak outflows earlier and the peak flows do not occur for as long a period of time. If located in the upper portion of a watershed, off-line ponds may worsen flooding problems further downstream, whereas downstream on-line ponds tend to worsen basin outlet area flooding. Off-line dry ponds can be used in conjunction with on-line wet ponds to advantage to provide both water quality and flood prevention benefits. Off-line ponds have an advantage in that they do not interfere with the passage of fish and other wildlife and they do not have to dramatically affect the physical character of the by-passed stream itself. On-line dry ponds would substantially degrade the stream habitat by removing cover and radically changing the channel dimensions. The peak flow rate reductions can also have significant bank erosion benefits in the vicinity of the pond, although these benefits would be decreased further downstream.

Yu, *et al.* (1996) monitored seven wetlands in Virginia for the Virginia Department of Transportation (VDOT). A total of 25 events had been evaluated, with the best pollution retention being more than 50% for suspended solids, about 30% for COD, and over 80% for orthophosphate, at a well-designed and well-maintained facility. They found

no harm to the wetland vegetation due to the highway runoff. They are also creating an Arc/Info GIS system to allow the VDOT to track the more than 200 mitigation wetlands that they have already constructed, plus the additional ones needed in the future. A stormwater model was also developed, specifically to predict pollution retention in the mitigation wetlands. They are using a modification of WASP4, with a multi-layered (sediment and water column) bucket wetland system.

Schueler (1996) summarized research on submerged bed wetland treatment systems for treating stormwater. Many wastewater treatment facilities have used submerged bed wetlands for polishing treatment. They have used rock or gravel media to grow emergent wetland plants. The wastewater slowly flows through a shallow rock-filled trench, where particulates settle and microbial and algal activity breakdown, and roots uptake, some of the pollutants. Schueler points out that most stormwater wetlands only treat surface flows and questions whether enhanced pollutant removal would occur with subsurface treatment also. He summarized a study conducted in Orlando, FL, by Tim Egan (of Dyer, Riddle, Mills and Precourt, Inc.) that tested several different submerged wetland cells for the treatment of stormwater, including two cells that were only filled with rock or crushed re-cycled concrete, and no plants. The stormwater was pretreated in a holding pond before being pumped into the cells. This pretreatment is necessary to reduce clogging and to equalize the flow rates through the cells. The reported average mass removal rates were: 81% for suspended solids, 78% for fecal coliforms, 75% for nitrate nitrogen, 14% for orthophosphate, 21% for copper, 73% for lead, and 55% for zinc. Interestingly, the crushed concrete filled cell performed better than any of the planted cells, probably because of the higher pH of the water in that cell. The rock surfaces were apparently more important than the root surfaces for pollutant removal by creating a larger surface area for epilithic algae and microbes.

Reed bed wetlands have been extensively used in the UK to treat CSO discharges at small treatment works. In Severn Trent, the local water department had more than 700 facilities serving less than 2,000 people (Green and Martin 1996). They had installed 55 reed bed systems by 1994, and plan to construct more, as resources allow. Detailed monitoring and tracer studies have been initiated at some of these facilities to confirm the stringent discharge limits that apply. The beds are constructed as shallow excavations lined with plastic or clay and then are filled with 5 to 10 mm diameter gravel to a depth of about 0.6 m. The water levels are checked at least weekly, and any evaporation is made up with secondary effluent. In one critical location, the overflow concentration limits are: 40 mg/L for BOD5, 60 mg/L for suspended solids, and 15 mg/L for ammonia nitrogen. They found that the reed beds provided consistent water quality improvements throughout the overflow hydrographs, although the initial improvement was mostly through dilution and dispersion. Continued pollutant reductions showed that pollutant uptake in the system was occurring, however.

The StormTreat™ system is a modular control device that includes sedimentation and plants (Allard, *et al.* 1996). One unit is 2.9 m in diameter and has a capacity of 5,260 L. The recommended detention time in the wetland portion of the unit (2,880 L) is 5 days. Multiple tanks are usually used at sites. Two tanks would be needed at a 0.4 ha paved site in order to capture 0.6 cm of runoff, if pre-treatment is provided. Five units would be needed otherwise. The units cost about \$US 4,000 each, including installation. Four events have been monitored at one site and show high removals of bacteria (83%), suspended solids (95%), COD (75%), orthophosphate (32%), dissolved nitrogen (44%), lead (65%), and zinc (90%). Other modular units commercially available for critical site treatment that rely mostly on sedimentation for pollutant removal include the Vortechs™ unit (from Vortech, Portland, ME), the Stormceptor™ (from Stormceptor Corp., Rockville, MD), and the Pollutec CDS™ unit (from CDS Technologies, Alpharetta, GA). These units may be promising for critical source area control, however, long-term monitoring data is needed for these units before their actual performance and maintenance requirements can be determined with confidence.

### ***Oil/Water Separators***

This section briefly examines the most widely available oil/water separation technologies and their expected ability to treat stormwater, as they are commonly assumed to be equivalent to detention facilities, but on a small scale. These devices include gravity separators (including API separators and separation vaults), coalescing plates separators, and cartridge filters added to oil/water separators. These devices are extensively used to treat industrial wastewaters and have been shown to be effective in those applications for which they were designed. These units perform best at very high levels of oil contamination, such as may be found at some industrial locations. About 90%

reductions in oil are possible if the influent oil concentrations are greater than about 10,000 mg/L. Reductions of about 50% would occur at influent oil concentrations of about 200 mg/L. Very little reduction is expected at levels less than about 100 mg/L. Little information is available demonstrating their effectiveness in treating stormwater, which usually has oil contamination levels of much less than 100 mg/L.

Other oil/water reduction technologies are used in some industrial applications, including separation tanks (typically small tanks used in shops that produce very small wastewater flows), and centrifuge separators (which require high energy demands and high maintenance, and are utilized in off-shore drilling operations). Neither of these technologies would be appropriate for the diffuse locations and highly irregular stormwater flows from critical source areas and are therefore not addressed in this report.

### **Gravity Separation**

Gravity separation relies on the density differences between oil and water. Oil will rise to the water surface unless some other contributing factor such as a solvent or detergent interferes with the process. For gravity units, this density difference is the only mechanism by which separation occurs. Other technologies, such as air flotation, coalescing plates, and impingement coalescing filters, enhance the separation process by mechanical means.

Gravity separators are the most basic type of separator and are the most widely used. They have few, if any, moving parts and require little maintenance with regard to the structure or operation of the device. Usually, separators are designed to meet the criteria of the American Petroleum Institute (API), and are fitted with other devices such as coalescing plate interceptors (CPI) and filters. Even though these separators are effective in removing free and unstable oil emulsions, they are ineffective in removing most emulsions and soluble oil fractions (Ford 1978). Furthermore, it is important to remember that no gravity oil/water separation device will have a significant impact on many of the other important stormwater pollutants, requiring additional treatment (Highland Tank).

#### Conventional American Petroleum Institute (API) Oil/Water Separator

The conventional API oil/water separator consists of a large chamber divided by baffles into three sections. The first chamber acts as an equalization chamber where grit and larger solids settle and turbulent flow slows before entering the main separation chamber. Often, manufacturers suggest the use of a catchbasin or interceptor tank as a pretreatment device so that coarse material will be kept from entering the oil/water separation tank. After entering the main chamber, solids settle to the bottom and oil rises to the top, according to Stokes' law. Larger API oil/water separators contain a sludge scraper which continually removes the captured settled solids into a sludge pit. The oil is also removed by an oil skimmer operating on the water surface. At the end of the separation chamber, all oil particles having a diameter of larger than the critical size have theoretically risen to the surface and have been removed by an oil skimmer. Small API units usually do not contain an oil skimmer, sludge scraper, or sludge pit. While they are less costly due to the absence of moving parts, they require more frequent cleaning and maintenance. These smaller units have been shown to be as effective as the larger more expensive units, if they receive proper maintenance at regular intervals.

The API (1990) stipulates that if their design criteria are met, then the separator will remove all oil droplets greater than about 150  $\mu\text{m}$  in diameter. The API reports that retention times are usually greater than the actual design values since actual flows are usually smaller than design flows, hence smaller droplets are removed most of the time. This finding is confirmed by Ruperd (1993) in a study of an oil/water separator treatment device in the community of Velizy, France. Also, API tanks are known to effectively remove large amounts of oil, including slugs of pure oil, and will not be overwhelmed (Tramier 1983). Studies have also shown that these separators can produce effluents down to 30 ppm (Delaine 1995), routinely at 30-150 ppm, with occasional concentrations above 150 ppm, depending upon the flow rate, and hence the retention times (Ford 1978).

The API has stated that very few separators with ratios of surface area to flow within the API design range achieved effluent oil concentrations lower than 100 ppm (API 1990). Therefore, the API separator is a recommended system for the removal of solids and gross oil as a pretreatment device upstream of another treatment system, if additional pollutants of concern are present, or if more stringent effluent standards are to be met.

The following is a partial list of oil/water separator manufacturers in the U.S.:

- Highland Tank and Manufacturing Co., One Highland, Rd. Stoystown, PA 15563
- McTighe Industries, P.O. Box 928, Mitchell, SD 57301-0928
- Xerxes Corp., 7901 Xerxes Rd. Minneapolis, MN 55431-1253

### Separation Vaults

Separation vaults are variations on the API oil/water separator design. They are usually either septic tanks or utility vaults that have been fitted with baffles in the manner of an API separator. They are usually poured in place or manufactured locally. Surveys of these vaults in King County, Washington, revealed that they had main chamber depths of 1.2 – 1.5 m (4 – 5 ft), widths of 1.2 – 1.8 m (4 – 6 ft), and lengths of about 1.8 m (6 ft). These vaults are not necessarily designed according to the previously stated API methods and therefore are termed separation vaults to differentiate them from conventional API oil/water separators (King County 1995). These vaults can theoretically achieve removal of all oil droplets of 75  $\mu\text{m}$  in size, or greater, however, practical removal sizes would probably be in excess of 150  $\mu\text{m}$ .

### **Coalescing Plate Interceptor Oil/Water Separators**

The coalescing plate interceptor (CPI) oil/water separators are simply conventional API oil/water separators and separator vaults with sets of parallel plates added to the main separation chamber. As small droplets of oil enter the plates, they rise until they encounter the next plate. Other drops also rise and coalesce. As the drops become larger, the buoyant forces acting on them become greater, eventually forcing the drops to slide off the plates and to rise quickly to the surface.

The total horizontal separator area requirement is reduced by the use of parallel plates by compacting the effective separation area into a limited space. The total area is the sum of the area of each plate projected on the horizontal plane, along with the open surface area of the separator itself. According to vendors, the use of coalescing plates can reduce spatial requirements of separators up to two-fold on width and ten-fold on length when used in place of a conventional separator without plates. Plates also help to dampen turbulence in the system, thus helping to maintain laminar flow. Oil collected from these systems has a lower water content than from conventional separators. The overall effluent oil content has been reported to be 60% lower for parallel-plate systems, with a higher proportion of small oil droplets recovered (Brunsmann 1962).

The earliest models of CPI separators used horizontal parallel plates. Currently, two types of parallel-plate separators are marketed: the cross-flow inclined plate separator and the down-flow inclined plate separator. In the cross-flow separator, flow enters the plates from the side and oil and sludge accumulates above and below the current. As oil and sludge build up, the oil then breaks free and rises, while the sludge descends to the separator bottom. In a down-flow separator, the water flows downward while oil rises to the above plate, and after coalescence, rises counter to the current to the top, while sludge will descend, helped along by the current.

The plates themselves are corrugated to improve oil and sludge collection. Vertical gutters are placed along the sides of the plates themselves at the influent and effluent points to aid in the collection of oils and solids. The plates are tilted at an angle of 45° - 60°, allowing sludge and oil to slide off, preventing clogging and resulting in lower maintenance requirements. A 45° angle has been found to be most effective for oil removal (Thanh and Thipsuwan 1978), but a 60° angle would reduce maintenance requirements further by insuring less clogging. However, a greater angle would also reduce the effective surface area as the effective surface is equal to the projection of the plates onto the horizontal plane (Branion 1978).

CPI separators have been found to remove droplets down to 30 to 60  $\mu\text{m}$  size (Ryan 1986; Romano 1990), and have been found to produce effluent concentrations in the range of 10 to 20 ppm (Delaine 1995; Dull 1984; Ryan 1986). CPI separators are a good treatment choice if the wastewater contains smaller droplets and possibly some unstable emulsions with larger diameter droplet sizes. Dissolved oil, stable emulsions, or a large amount of unstable emulsions would decrease the performance of the coalescing plate interceptor separators.

The API notes that it is difficult to describe the separation process in a parallel plate separator due to the variability of plate size, spacing, and inclination. They recommend that users rely on the empirically-derived recommendations of the plate unit vendors when selecting a coalescing plate interceptor separator.

### **Impingement Coalescers and Filtration Devices**

Filtration devices are used as post-treatment after separation in coalescing plate separators, and greatly improves the removal efficiency of a system. Many systems utilize these devices for treatment of industrial runoff; however, they are occasionally used in stormwater applications as well (Aires 1995). The most common type used is a vertical tube coalescer which has a random matrix of vertical tubes made of polypropylene fitted together in bundles. These bundles are placed towards the end of the separation tank before the outlet and after the coalescing plates; however, some manufacturers use these devices in place of plate systems. Oleophilic (oil-loving) filters provide a maximum coalescing surface, as well as helping to create a more laminar flow. These types of devices can provide better oil removal than a tank fitted only with coalescing plates, often with effluents suitable for direct discharge into surface waters.

Solids are trapped in sharp turns or crevices while oils are removed by two mechanisms occurring within the filters. First, the small passages in the filters allow the oil droplets to come in contact with each other and coalesce together. Second, the oleophilic properties of the media attract oil droplets and hold them until they coalesce with other trapped droplets until they eventually break free and rise to the surface.

The cartridge bundles can be removed and cleaned for reuse, although disposable filters are sometimes used. Disposable cartridge filters have the benefit of having simple maintenance requirements: when filters become clogged or saturated, they are simply removed and discarded. However, this process in itself may be a drawback in that the cartridges may need to be disposed of as a hazardous waste. Further, the cost of filters may be high and quickly reduce any benefit gained from reduced maintenance. Filters are typically made from fiberglass, nylon, polypropylene, and polyurethane foam; and are normally recommended as a secondary stage of treatment after gross solids and oil have been removed (Webb 1991).

Other problems exist with filter cartridges as well. Filters are easily clogged, even when pretreatment occurs. Also, if stable emulsions are present, surfactants will poison the filter by interfering with the surface-wetting properties of the filter (Tabakin, *et al.* 1978). Despite these problems, filters are known to remove oil to concentrations as low as 10 ppm, with all droplets greater than 20  $\mu\text{m}$  being removed (Xerxes Corp).

### **Maintenance of Oil/Water Separators**

Problems with oil/water separators can be attributed largely to poor maintenance by allowing waste materials to accumulate in the system to levels that hinder performance and to levels that can be readily scoured during intermittent high flows. When excess oil accumulates, it will be forced around the oil retention baffle and make its way into the discharge stream. Also, sludge buildup is a major reason for failure. As waste builds up, the volume in the chamber above the sludge layer is reduced and therefore the retention time is also reduced, allowing oil to be discharged. Therefore, the efficiency of oil/water separators in trapping and retaining solids and hydrocarbons depends largely upon how they are maintained. They must be designed for ease of maintenance and be frequently maintained. Apparently, few oil/water separators built for stormwater control are adequately maintained.

Manufacturers of prefabricated oil/water separators, as well as the American Petroleum Institute, all recommend periodic inspection and maintenance. Some manufacturers advise that these devices be cleaned twice per year, even if the device is apparently working properly. However, it is best if the devices are inspected after every rainfall to determine the rate of hydrocarbon and sludge buildup. The most effective maintenance schedule can then be obtained for each individual device. French researchers also advocate this approach, by developing individual maintenance schedules after intensive observations for six months (Aires 1995).

Ease of maintenance must be considered when designing separators, including providing easy access. Maintenance on these devices is accomplished by using suction equipment, such as a truck mounted vacuum utilized by personnel trained to handle potentially hazardous waste. The vacuum is used to skim off the top oil layer and the device is then drained. In larger devices, the corrugated plates are left in place, but otherwise, they are lifted out along with any

other filter devices that are present. The sludge is then vacuumed out or shoveled out and any remaining solids are loosened by spraying hot water at normal pressure.

Maintenance of parallel plate units and coalescing filters is similar. The separator is drained and the plates are washed by spraying. If there is inadequate space, then the plates will need to be lifted from the separator for effective cleaning. Cleaning should occur when coating of the plates is evident and before accumulations begin to clog the spaces. Cleaning of polypropylene coalescing tubes is also accomplished by lifting out the tube bundles and cleaning with a hose or high pressure water spray to remove accumulated oil and grit. Sludge is removed from underneath the coalescer supports and the coalescers are then replaced. No soaps or detergents are used in cleaning polypropylene components as they would destroy the oleophilic nature of the material.

### **Performance of Oil/Water Separators for Treating Stormwater**

Manufacturers state that efficiencies observed during testing of oil/water separators are on the order of 97 – 99% for the removal of oil from wastewater. The test method typically applies oil to a paved washpad, with water added via a sprinkler system to simulate rainfall. Oil is of a specified density (typically 0.72 – 0.95). These synthetic events are necessary to evaluate the performance of a separator but do not necessarily reflect the processes which occur during actual rainfall conditions where rapidly changing flows rates, unknown oil mixtures, and other pollutants are present. Published research is difficult to find on how these units actually perform once placed in operation.

Interception of solid particles through settling, and flotation of oils and other floatables are processes occurring within an oil/water separator. French studies have shown that the average SS removal efficiency of separators is about 50% (Aires 1995). Oil/water separation requires an ascending speed of about 8 m/h, while the settling velocity of solids require descending velocities on the order of 1 to 3 m/h. At rates of 20% of the design flow rate, about 80% of the solids are removed; at 30% of the design flow rate, about 50% of the solids are removed. Negative removals also occur as the result of resuspension of previously settled material (Legrand, *et al.* 1994).

In many instances, pretreatment tanks are placed before the oil/water separator to remove settleable solids before stormwater enters the separator. A study in Velizy, France, found that the SS removal efficiency of a separator, placed downstream of a settling pond, was about 13%. This low value was attributed to the fact that solids had been allowed to settle during pretreatment, and therefore influent to the device had a low content of only the most difficult to remove solids (Ruperd 1993).

When the concentration of the oil in the wastewater is high, the oil removal efficiency increases. In Velizy, France, Ruperd (1993) found that oil/water separators fitted with cross current separators had removal efficiencies ranging from zero to 90%, with an average of 47%. Low efficiencies were associated with low influent levels and greater efficiencies were associated with higher influent levels. This finding supports those of Tramier (1983), stated earlier, that separators are effective in removing large amounts of oil when the oil concentrations are elevated.

The Metropolitan Washington Council of Governments (Washington, D.C.) has conducted a survey of 109 separator vaults in suburban Maryland and subsequently examined 17 in detail to determine their long-term effectiveness (Schueler and Shepp 1993). These separators were used for controlling runoff from areas associated with automobile usage. These separators were either pre-cast or poured in place concrete structures consisting of one, two or three chambers. The results of this study revealed that the amount of trapped sediments within separators varied from month to month and that the contained waters were commonly completely displaced during even minor storms (Shepp and Cole 1992).

Of the original 109 separators that were observed in the survey, devices less than one year old were effective in trapping sediments. Devices older than one year appeared to lose as much sediment than they retained (Shepp and Cole 1992). Not one of these separators had received maintenance since their installation. Survey observations suggested no net accumulation of sediment over time, in part because they received strong variations in flow. Of the 109 separators surveyed in this suburban Maryland study, 100% had received no maintenance, 1% needed structural repair, 6% were observed to have clogged trash racks, 84% contained high oil concentrations in the sediments trapped in their first chamber, 77% contained high oil concentrations in the sediments trapped in their second

chambers, 27% contained high oil and floatables loading in their first chambers, and 23% contained high oil and floatables loading in their second chambers.

Numerous manufacturers have developed small prefabricated separators to remove oils and solids from runoff. These separators are rarely specifically designed and sized for stormwater discharges, but usually consist of modified oil/water separators. Solids are intended to settle and oils are intended to rise within these separators, either by free fall/rise or by counter-current or cross-current lamella separation. Many of these separators have been installed in France, especially along highways (Rupperd 1993). Despite the number of installations, few studies have been carried out in order to assess their efficiency (Aires and Tabuchi 1995).

The historical use of oil/water separators to treat stormwater has been shown to be ineffective for various reasons, especially lack of maintenance and poor design for the relatively low levels of oils present in most stormwaters (Schueler 1994). Stormwater treatment test results from Fourage (1992), Rupperd (1993) and Legrand, *et al.* (1994) show that these devices are usually greatly under-sized. They may possibly work reasonably well at flow rates between 20 and 30% of their published design hydraulic capacities. For higher flow rates, the flow is very turbulent (the Reynolds numbers can be higher than 6000), and improvements in settling by using lamella plates is very poor. These devices need to be cleaned very frequently. If they are not cleaned, the deposits are scoured during storm events, with negative efficiencies. However, the cleaning is usually manually conducted, and expensive. In addition, the maintenance job is not very easy because the separators are very small. Some new devices are equipped with automatic sediment extraction pumps which should be a significant improvement. Currently, these researchers have found that the cleaning frequencies are very insufficient and the stormwater quality benefits from using oil/water separators are very limited.

### **Problems With Wet Detention Ponds**

Wet detention ponds may experience various operating and nuisance problems. The following discussion attempts to describe these negative aspects of wet ponds, as reported in the literature, and to describe how they have been overcome through specific designs.

#### ***Safety of Wet Detention Ponds***

The most important wet detention pond design guidelines are to maintain public safety. The following discussion briefly summarizes common suggestions to maintain and improve safety at wet detention facilities. Death by drowning is the most common safety concern associated with wet detention ponds. Marcy and Flack (1981) state that drownings in general most often occur because of slips and falls into water, unexpected depths, cold water temperatures, and fast currents. Four methods to minimize these problems include: eliminate or minimize the hazard, keep people away, make the onset of the hazard gradual, and provide escape routes. Many of the design suggestions and specifications contained in this discussion are intended to accomplish these methods.

Jones and Jones (1982) consider safety and landscaping together because landscaping can be an effective safety element. They feel that appropriate slope grading and landscaping can provide a more desirable approach than wide-spread fencing around a wet detention pond. Fences are expensive to install and maintain and usually produce unsightly pond edges. They collect trash and litter, challenge some individuals who like to defy barriers, and impede emergency access if needed. Marcy and Flack (1981) state that limited fencing may be appropriate in special areas. When the pond side slopes cannot be made gradual (such as when against a railroad right-of-way or close to a roadway), steep sides having submerged retaining walls may be needed. A chain link fence located directly on the top of the retaining wall very close to the water's edge would be needed (to prevent human occupancy of the narrow ledge on the water side of the fence). Another area where fencing may be needed is at the inlet or outlet structures. However, fencing usually gives a false sense of security, as most can be easily crossed (Eccher 1991).

A following discussion on pond side slopes stresses gradual slopes near the water edge and a submerged ledge close to shore. Aquatic plants on the ledge would decrease the chance of continued movement to deeper water and thick vegetation on shore near the water edge would discourage access to the water edge and decrease the possibility of falling into the water accidentally. Pathways should not be located close to the water's edge, or turn abruptly near the water.

Marcy and Flack (1981) also encourage the placement of escape routes in the water whenever possible. These could be floats on cables, ladders, hand-holds, safety nets, or ramps. They should not be placed to encourage entrance into the water.

The use of inlet and outlet trash racks and antivortex baffles is also needed to prevent access to locations having dangerous water velocities. Several types are recommended by the NRCS (SCS 1982), as shown on Figure 7. Racks need to have openings smaller than about 6 inches to prevent people from passing through them and need to be placed where water velocities are less than three feet per second to allow people to escape (Marcy and Flack 1981). Besides maintaining safe conditions, racks also help keep trash from interfering with the outlet structures operation.

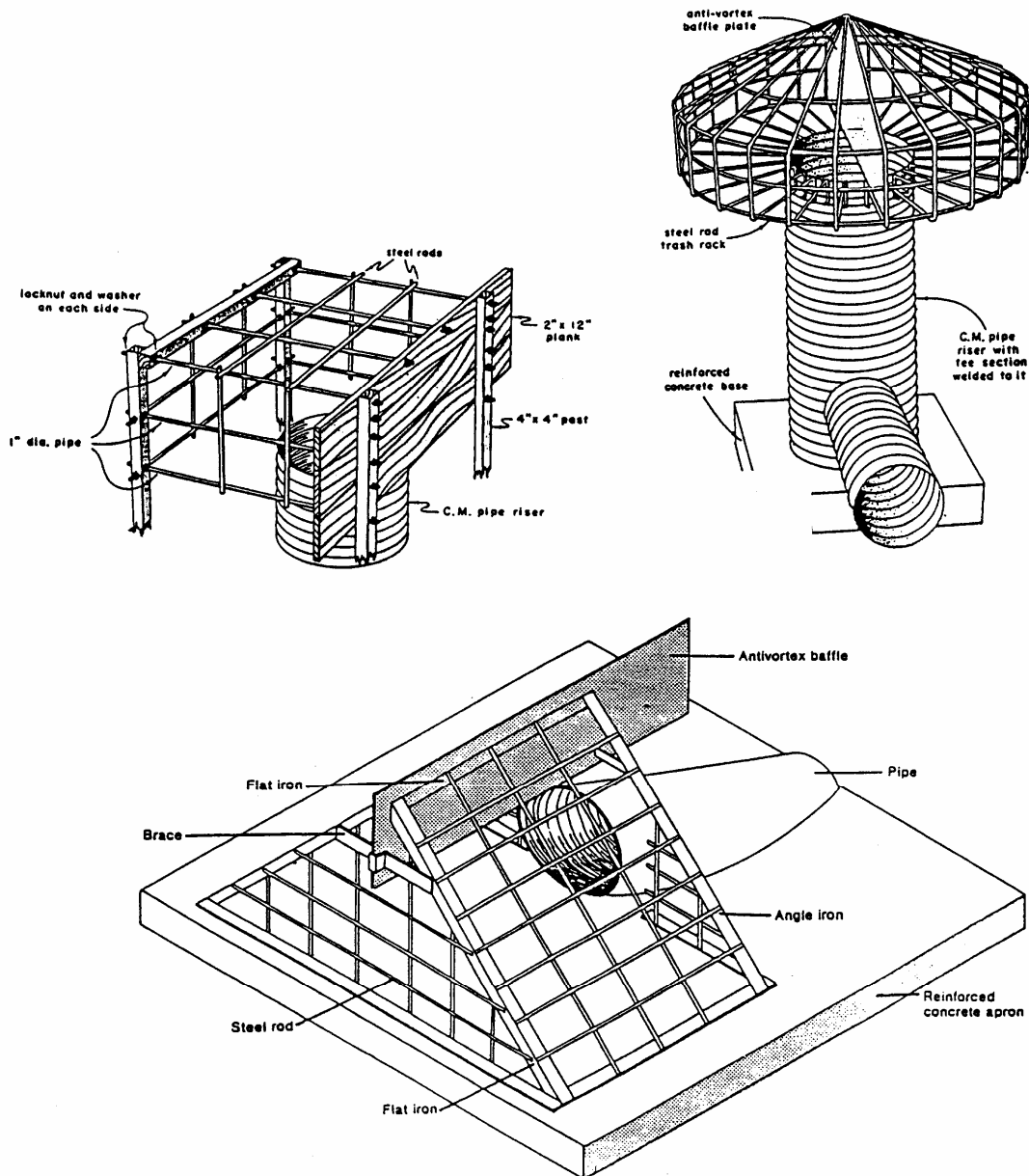

Figure 7. Various trash racks and baffles used by the SCS (NRCS). (SCS 1982).



Eccher (1991) lists the following pond attributes to ensure maximum safety, while having good ecological control:

- 1) There should be no major abrupt changes in water depth in areas of uncontrolled access,
- 2) slopes should be controlled to insure good footing,
- 3) all slope areas should be designed and constructed to prevent or restrict weed and insect growth (generally requiring some form of hardened surface on the slopes), and
- 4) shoreline erosion needs to be controlled.

### ***Nuisance Conditions in Wet Detention Ponds and Degraded Water Quality***

Most new detention ponds require from three to six years before an ecological balance is obtained (Ontario 1984). Excessive algal growths, fish kills, and associated nuisance odors may occur during this period, creating management problems for municipal officials and developers. Water quality is also generally poor in wet detention ponds, but unauthorized swimming can be common if alternative swimming facilities are not conveniently available. The poorest water and sediment quality in wet detention ponds usually occurs near the inlets and in depressions (Free and Mulamootil 1983 and Wigington, *et al.* 1983). Some urban lakes have also been subjected to duck plagued disease which is a deadly virus that thrives in lakes having excessive algae growths (Ontario 1984).

Schueler (1986) and with Galli (1992) reported that water discharged from wet detention ponds may be warmed by as much as 10 to 15° F in the summer months, unless shaded or subsurface dischargers are used.

The haphazard installation of detention ponds can increase downstream flooding and erosion problems if a regional hydraulic analysis and careful plan is not developed and followed (Duru 1981, Jones and Jones 1982, and Hawley, *et al.* 1981). This can occur by increasing the duration of erosive flow velocities and by adding the delayed high discharge flows from a pond to the natural high flows from upstream areas. These problems can be substantially reduced with careful design and maintenance, as described in the following paragraphs.

### ***Attitudes of Nearby Residents and Property Values***

Wet Detention ponds may create potential nuisance conditions if they are not properly designed or maintained. However, many people living near wet detention ponds do so because of the close presence of the wetlands, and their property values are typically greater than lots further from the ponds (Marsalek, *et al.* 1982). They also reported that small (well maintained) wet detention ponds are less subject to controversy than larger ponds (that are more commonly neglected). Debo and Ruby (1982) summarized a survey conducted in Atlanta of residents living near and downstream of 15 small detention ponds and found that almost half of the people surveyed who lived in the immediate areas of the ponds did not even know that they existed. Wiegand, *et al.* (1986) found that wet detention ponds, when properly maintained, are more preferred by residents than any other urban runoff control practice.

Emmerling-DiNovo (1995) reported on a survey of homeowners in the Champaign-Urbana area living in seven subdivisions having either dry or wet detention ponds. She reported that past studies have recognized that developers are well aware that proximity to water increases the appeal of a development. Detention ponds can create a sense of identity, distinguishing one development from another, and can be prominent design elements. Increased value is important because the added cost of the detention facility, including loss of developable land, must be recovered by increasing the housing costs. Others have also found that the higher costs of developments having stormwater detention facilities can also be offset by being able to sell the housing faster. In a prior survey in Columbia, MD, 73% of the respondents would be willing to pay more for property located in an area having a wet detention pond if designed to enhance fish and wildlife use. Although the residents were concerned about nuisances and hazards, they felt that these concerns were out-weighted by the benefits. In her survey, Emmerling-DiNovo (1995) received 143 completed surveys. Overall attractiveness of the neighborhood was the most important factor in purchasing their home. Resale value was the second most important factor, while proximity to water was slightly important. More than 74% of the respondents believed that wet detention ponds contributed positively to the image of the neighborhood and they were a positive factor in choosing that subdivision. In contrast, the respondents living in the subdivisions with the dry ponds felt that the dry ponds were not a positive factor in locating in their subdivision. Respondents living adjacent to the wet ponds felt that the presence of the pond was very positive in the selection of

their specific lot. The lots adjacent to the wet ponds were reported to be worth about 22% more than lots that were not adjacent to the wet ponds. Lots adjacent to the dry ponds were actually worth less (by about 10%) than other lots. Dry detention ponds actually decreased the assessed values of adjacent lots in two of the three dry basin subdivisions studied. The respondents favored living adjacent to wet ponds even more than next to golf courses. Living adjacent to dry ponds were the least preferred location.

Another example of increased land value occurred in Fairfax, VA (Land and Water 1996). A 1.6 acre wet detention pond was constructed using a modular concrete block retaining wall system. Total construction time was about six weeks and resulted in an attractive pond that added substantial value to the new housing development.

The Hennepin (MN) park district (John Barten, personal communication) reports that the park district is frequently asked by developers to be allowed to “improve” the parks by putting their wet detention ponds on park land that is adjacent to new developments. Needless to say, the park district cannot afford to convert their dry land to lakes which would dramatically decrease the utilization of the park by the park users. The park district is also frequently asked by residents of subdivisions to improve the water quality in the wet detention ponds located in their subdivisions, especially to allow fishing and swimming. The residents do not understand that their “lake” is actually a water treatment system and is not a natural lake or park and is not intended for water contact recreation or fishing. However, because many of these subdivisions are marketed by stressing the benefits of “lakeside” living, some of the residents expect the city to improve the wet detention ponds for recreational use. The park department, under a lot of citizen and political pressure, has actually had to construct new wet detention ponds upstream of some of these wet detention ponds.

### **Maintenance Requirements of Wet Detention Ponds**

In order for detention ponds to perform as anticipated, they must be regularly maintained. Poor operation and maintenance not only reduces the pollutant and flow rate reduction effectiveness of detention ponds, but can cause detention facilities to become eyesores, nuisances, and health hazards (Poertner 1974). If a pond does not “need” maintenance (such as sediment removal), then it is not providing significant water quality benefits. Ponds can be designed to minimize maintenance, however, a maintenance free detention facility (that is working properly) does not exist (SEMCOG 1981).

Institutional arrangements must be made to insure continued detention pond maintenance after construction. SEMCOG (1981) recommends that appropriate maintenance programs specifically identify the organization or person who will perform the maintenance and how the maintenance operations will be financed. They also found that major detention pond maintenance (dredging) is usually needed within about ten years after pond construction. More frequent (routine) maintenance may include: structural repairs (bank stabilization), removal of debris and litter from the water and surrounding land, grass cutting, fence repairing, algal control, mosquito control, and possible fish stocking. Wet detention ponds require a lot of attention.

### ***Routine Maintenance Requirements***

The following summary of routine maintenance requirements is based on a discussion by Schueler (1987).

#### **Mowing**

The most costly routine maintenance required of a detention facility is mowing the surrounding area. In residential areas, frequent mowing (up to 12 times a year) may be necessary to maintain a lawn surrounding the pond. Some native plants (such as in the small prairie surrounding the Monroe Street detention pond in Madison at the University of Wisconsin Arboretum) require much less maintenance. In all cases, the emergency spillway, side slopes, and pond embankments need to be mowed at least twice a year to control undesirable plants that may interfere with pond operation. Attractive landscaping and adequate landscaping maintenance are always needed. Careful plant selection (water and salt tolerant, disease and winter hardy, and slow growing) should be made in conjunction with a landscape architect or the Natural Resources Conservation Service.

#### **Debris and Litter Removal**

During the routine mowing operations and after each major storm, debris and litter should also be removed from the site, especially from the inlet and outlet grates and the water surface.

### **Inspections**

Wet detention ponds need to be inspected at least once a year, and after each major storm. The inspection should include checking the pond embankments for subsidence, erosion, and tree growth. The conditions of the emergency spillway and inlets and outlets also need to be determined during the inspection. The adequacy of any channel erosion protection measures near the pond should also be investigated. Sediment accumulation in the pond (especially near, and in, the inlets and outlets) also needs to be examined.

### ***Sediment Removal from Wet Detention Ponds***

Large sediment accumulations in detention ponds can have significantly adverse affects on pond performance. Bedner and Fluke (1980) reported on the long term effects of detention ponds that received little maintenance. Lack of dredging actually caused the silted-in ponds to become a major sediment source to downstream areas. Poorly maintained ponds only delayed the eventual delivery of the sediment downstream, they did not prevent it.

Based on the NURP detention pond monitoring results (EPA 1983), a pond having a surface area of about 0.6 percent of the contributing area should remove about 90 percent of the settleable solids (particulate residue) from the runoff. The Milwaukee NURP project (Bannerman, *et al.* 1983) estimated an annual sediment delivery of about 500 pounds per acre for medium density residential land uses and about 2500 pounds per acre for commercial areas. Other land uses contribute sediment generally between these values. Assuming a density of about 120 pounds per cubic feet, about 3.6 and 18 cubic feet of sediment would be deposited in a well designed detention pond for each medium density residential or commercial acre per year. With a pond 0.6 percent of the contributing area in size, this would only result in the deposition of between 0.2 and 0.9 inches per year. McComas and Sefton (1985) report two measured sediment accumulation rates in Chicago area wet detention ponds (about two and three percent of the drainage pond in size) of 0.24 and 1.3 inches per year. Kamedulski and McCuen (1979) report a much greater sedimentation rate of about three inches per year in another pond. When uncontrolled construction site erosion is allowed to enter a detention pond, the pond can literally fill up over night.

Most of the sedimentation would occur near the inlet and the resulting sediment accumulation would be very uneven throughout the pond. Sediment removal in a wet pond may therefore is needed about every five to ten years, depending on the variation in sediment deposition over the pond and the sacrificial storage volume designed. It is therefore necessary to plan for required maintenance during the design and construction of detention ponds. Ease of access of heavy equipment and the possible paving of a sediment trap near the inlet would ease maintenance problems. Deposited sediment can be heavily polluted and may require special disposal practices. Sediment concentrations of up to 100,000 mg organic carbon, several thousand mg lead, several hundred mg zinc, and more than ten mg arsenic per kg dry sediment are not uncommon for lakes receiving urban runoff (Pitt and Bozeman 1979). Dredged sediment is usually placed directly onto trucks, or is placed on the pond banks for dewatering before hauling to the disposal location. One common practice is to keep an area adjacent to the detention pond available for on-site sediment disposal. Small mounds can be created of the dried sediment and covered with top soil and planted.

Poertner (1974) reviewed various sediment removal procedures. An underwater scoop can be pulled across the pond bottom and returned to the opposite side with guiding cables. If drains and underwater roads were built during the initial pond construction, the pond can be drained and front-end-loaders, draglines, and trucks can directly enter the pond area. Small hydraulic dredges can also be towed on trailers to ponds. The dredge pumps sediment to the shore through a floating line where the sediment is then dewatered and loaded into trucks or piled. A sediment trap (forebay) can also be constructed near the inlet of the pond. The entrances into the pond are widened and submerged dams are used to retain the heavier materials in a restricted area near the inlets. This smaller area can then be cleaned much easier and with less expense than the complete pond. Hey and Schaefer (1983) report the successful use of a submerged dam across the pond inlet in Lake Ellyn, near Chicago.

The estimated cost of removing sediment from a detention pond varies widely, depending on the amount to be removed and the disposal requirements. Costs as low as one dollar per cubic yard have been reported, but this low cost does not include any possible special disposal practices. Sediment removal costs are estimated to generally range from about \$5 to \$25 per cubic yard of sediment removed.

### **Problems with Contaminated Sediments in Wet Detention Ponds**

Frequently, concern arises about the safety of disposing sediments from wet detention ponds. There have recently been several studies that have addressed this issue, as summarized in the following paragraphs.

Dewberry and Davis (1990) analyzed sediments from 21 ponds in northern Virginia. They found trace metals in many of the sediments, but the available forms of the metals were significantly less than applicable toxic thresholds. They concluded that the dredged materials could be safely disposed either on-site or at sanitary landfills without danger of health problems. However, they recommend that sediment samples from specific ponds be analyzed before dredging.

Yousef and Lin (1990) conducted extensive pond water quality and sediment quality analyses in six wet detention ponds in Florida as part of a Florida Dept. of Transportation study to develop pond maintenance procedures. The ponds had all been constructed from 4 to 13 years prior to analyses and received runoff from various urban watersheds that all contained different amounts of highway runoff. The dissolved oxygen levels in the ponds all dropped significantly with depth, in many cases being lower than 1 mg/L at the water-sediment interface. The pH of the pond water was also generally acidic in all of the ponds, being from 5.5 to 7.2 throughout the water columns. The temperature differences between the water surface and the bottom of the ponds was generally less than 1°C. The sediment accumulation rates were found to be between 0.25 and 0.72 cm per year and correlated with pond age, size of drainage basin and size of pond. The bottom material was found to be poorly graded sand. Appreciable amounts of heavy metals (Cu: 7 to 73 µg/g, Ni: 12 to 82 µg/g, Pb: 84 to 1025 µg/g, and Zn: 13 to 538 µg/g), and nutrients (N: 1.1 to 5.2 mg/g, and P: 0.1 to 1.2 mg/g) were found in the surface layers of the sediments. However, the concentrations of the pollutants decreased rapidly with depth, generally being less than 10% of the surface sediment concentrations below 20 cm beneath the water-sediment interface. The bottom sediments were also analyzed to determine the TCLP extractable portions of the metals. These were found to be significantly less than the whole sediment metal concentrations (Cu: 0.13, Ni: 0.31, Pb: 0.27, and Zn: 0.33). They determined that the TCLP extractable fraction was lowest for sediments having higher clay and organic material. They concluded that the sediments could be removed during normal maintenance operations and disposed of on non-agricultural land.

Jones (1995) and Jones, *et al.* (1996) discuss the implications that the Resource Conservation and Recovery Act (RCRA) may have on sediments that need to be removed from stormwater management facilities, as summarized in the following discussion. The “mixture” (40 CFR Section 261.3(a)(2)(iv)) and “derived from” (40 CFR Sections 261.3(c)(2)(1) and 261.3(d)(2)) rules can cause sediments having very low concentrations of pollutants to be classified as “hazardous.” These regulations are likely to be changed, with clearer definitions for non-hazardous operations and facilities. Sediments are evaluated as being hazardous when the wet detention pond is being dredged, not while they remain in-place. Many of the materials that are listed as hazardous under RCRA may enter stormwater, especially at vehicle service facilities, industrial facilities, and even golf courses and parks. These include solvents, degreasers, hydraulic fluids, herbicides, fungicides, and pesticides. For the sediments to be considered hazardous under the current RCRA mixture rule, the source of the specific material containing the listed hazardous material must contain more than 10% of the hazardous material. This is irrespective of how much of the material actually enters the stormwater. Therefore, site inventories become important tools in determining if a sediment would be classified as hazardous. If a listed material is used on the site, but it would not come in contact with rain (either through normal use or spills), the sediment would not likely be classified as hazardous. It is difficult to conduct detailed site surveys for a large drainage area having many separate owners, but it is feasible for small wet ponds serving single facilities. Jones (1995) and Jones, *et al.* (1996) also discuss other options to minimize the chance that wet pond sediment would be classified as hazardous under RCRA:

- Reduce the likelihood that listed substances would come in contact with precipitation or runoff.
- Inventory and track hazardous materials and encourage the use of less toxic replacement compounds.
- Install stormwater pre-treatment facilities to localize the problem.
- Reduce the accumulation rate, and increase the storage area for sediment in the pond.

### ***Vegetation Removal from Wet Detention Ponds***

In shallow detention ponds, excessive rooted aquatic plant (macrophyte) growths may occur over the entire pond surface. In deeper ponds, rooted aquatic plant growths are usually restricted close to the shoreline (Ontario 1984).

Floating algae may create problems anywhere in a lake, irrespective of pond depth. As noted earlier, a narrow band of natural rooted aquatic plants along the narrow “safety” shelf is desirable as a barrier and to add habitat for pond wildlife.

Excessive algal growths create nuisance problems with strong odors, but more serious problems may also occur. Schimmenti (1980) reports that decaying vegetation, if not removed, promotes the breeding of mosquitoes. Certain types of algae (Anabaena, Aphanizomenon, and Anacystis) naturally produce toxins that can kill animals (including fish) which drink the water and can cause skin irritation and nausea in humans (Ontario 1984). Algae is usually mechanically controlled in detention ponds by using algae harvestors or by dewatering the pond. Certain fish also consume large amounts of algae, but the most common type of algae control is by using aquatic herbicides. Many rooted aquatic plant growth problems can be significantly reduced by using a deep pond which restricts light penetration.

Small weed harvestors can be delivered to a detention pond by trailer. The use of chemicals for algae control is popular, but must be carefully done to prevent contamination of the receiving water. Dead algae and rooted plants must also be removed to prevent odor and dissolved oxygen problems. Mechanical barriers can also be placed on the pond bottom to reduce rooted aquatic plant growth. AquaScreen is a fairly fine, dark mesh that is laid on the pond bottom that restricts sunlight from reaching the rooted aquatic plants. In tests conducted on Lake Washington, Perkins (1980) concluded that a two or three month use of the material resulted in about an 80 percent reduction of rooted aquatic plants where the material had been placed. Again, increased pond depth, possibly at less cost, can do the same thing.

### **Detention Pond Costs**

Reported construction costs of detention facilities vary widely due to land value variations and special site or landscaping considerations. Even though the costs of detention facilities appear high, many benefits are available, besides just water quality, that offset these costs. Some of these other benefits directly affect the cost of the development and may include using the wet pond as part of a fire protection system (as described below), and the obvious cost savings associated with reducing the size of parts of the downstream drainage system. In many cases, wet detention ponds have also significantly increased the value of the property due to increased landscaping and recreation benefits.

A series of nine inter-connected wet detention ponds at a hospital site in Southern California cost about \$275,000 (about \$30,000 per pond), including a pumping system for water recirculation (Rutherford 1977). This cost was about 25 percent of the total site grading, drainage, and paving costs. These ponds resulted in more than a million dollars in savings because the ponds were used as an emergency fire water supply instead of having to build conventional water storage tanks.

The costs of ten detention pond systems were compared by Chambers and Tottle (1980). The total drainage system costs with detention ranged from about \$1200 to \$11,500 per acre of land served, and averaged about \$5200 per acre of pond. Most of these detention systems produced significant peak runoff flow rate reductions, allowing substantial decreases in the sizes of the stormdrain pipes. Average savings were about \$2500 per acre of watershed served, or about 35 percent of the total drainage system costs. Cheng (1981) conducted a similar cost comparison analysis and estimated cost savings of about \$1800 per acre (1976 dollars). Although long-term maintenance costs of the detention ponds were not considered in these analyses, neither were additional benefits besides drainage system cost savings.

In a cost analysis conducted by the Ontario Ministry of the Environment (1984), on-site drainage systems containing detention facilities were generally found to have about the same costs as conventional systems. However, in almost all cases no additional off-site stormwater management measures were needed, in marked contrast to the conventional systems. Off-site increased pipe sizes and channels increased the total construction costs of the conventional systems by about 150 to 300 percent as compared to the alternatives containing on-site detention. On-site detention also substantially decreased the flood plain along the main channels, increasing the total area available for development, even when considering the land needed for on-site detention.

Poertner (1974) also presented several examples where on-site detention resulted in substantial savings to the site developers when compared to conventional drainage systems. In one example, providing on-site detention in a large residential development cost about \$100 to \$300 per lot, substantially less than providing conventional drainage systems.

The EPA (1983) analyzed costs associated with wet detention ponds construction for the NURP projects, as shown on Figure 8. A pond that covers 0.5 percent of a 150 acre watershed area would cost about \$50 per watershed acre per year. This sized pond should remove between 80 and 90 percent of the annual suspended solids loading. These costs are for newly developed areas and are not applicable for estimating costs of retro-fitting a pond in an established area.

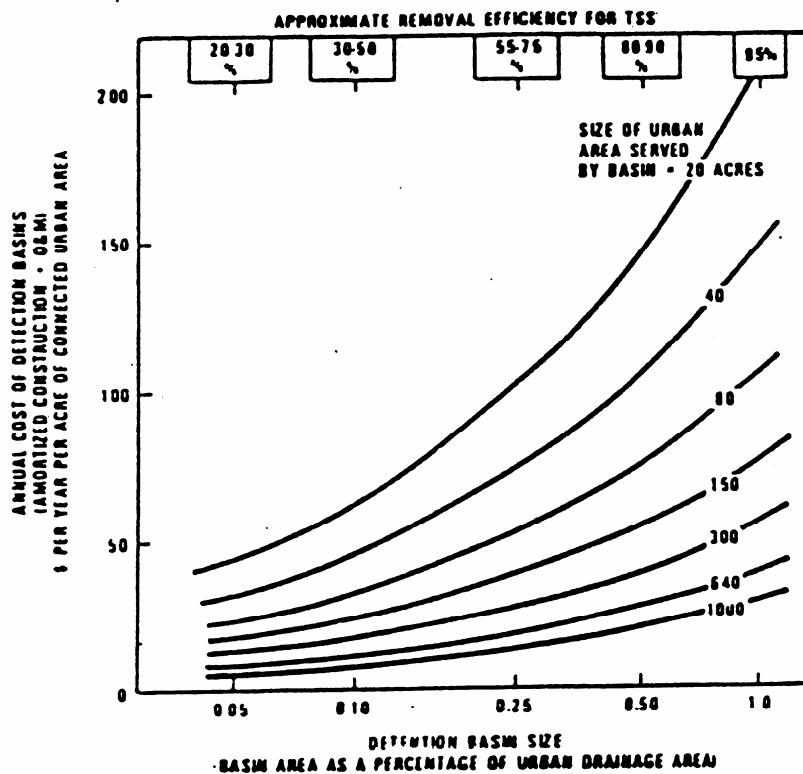

Figure 8. Detention pond costs (EPA 1983).

A detention pond and infiltration trench cost study in the Washington, D.C. area (Wiegand, *et al.* 1986) was based on a survey of engineering estimates and construction bids for 65 facilities constructed since 1982. They found that construction costs (excluding land purchase costs) varied mostly as a function of storage volume of the device ( $V_s$ ). Their wet detention pond cost estimate equation was based on facilities having storage volumes (total storage in cubic feet, not just freeboard storage above the normal water level) greater than 100,000 cubic feet:

$$\text{Cost} = 34 V_s^{0.64}$$

This equation reflects a substantial cost savings with increasing size. As an example, a 0.5 acre pond (five feet deep) would cost about \$50,000 (or \$120,000 per pond acre), while a nine acre pond (also five feet deep) would cost about \$400,000 (or about \$40,000 per pond acre). In an interesting comparison, they did not find any significant differences in costs between large wet and dry detention ponds, probably because the wet ponds had greater

economics of scale. However, smaller wet ponds were generally about 30 to 60 percent more expensive than small dry ponds (Schueler 1986). Schueler has recently reexamined these detention pond costs and has found that they have increased by about 15% since 1986 due to inflation (Schueler unpublished 1997).

It is incorrect to directly compare the costs of wet ponds with dry ponds because of their very different objectives. When runoff water quality (of particulate pollutants) is the prime concern, then wet ponds are most appropriate, while dry ponds can be best used when peak flow rate reductions are desired. It is possible to design a wet pond to also achieve peak flow rate reduction objectives by increasing the freeboard pond storage and by careful design of the outlet structures. However, it may be best to construct a separate dry detention pond in series with a wet detention pond (or to use other upland source area controls, such as grass swales or infiltration devices) to achieve these multiple objectives.

Wiegand, *et al.* (1986) also examined the cost components of wet detention pond construction:

Cut and fill excavation	61%
Inlet and outlet works	18
Riprap	9
Land clearing	5
Sediment erosion control	5
Other	2

Excavation costs were the greatest wet pond cost component. Wet ponds required about 60 percent more excavation than dry ponds of comparable working volume. This extra excavation is often necessary to provide the needed permanent pool storage for wet ponds.

Maintenance is a necessary part of any stormwater management system, and the associated maintenance costs must be recognized along with the construction costs. Chambers and Tottle (1980) estimated that the annual maintenance costs for detention facilities to be about \$35 (1978 dollars) per acre served per year, not considering sediment removal. About one-half of these annual costs are associated with maintaining the grassed embankments, about 25 percent is associated with weed and algae control, and the remaining 25 percent is associated with inspection and litter removal.

Sediment removal and disposal can be substantially greater than these other maintenance costs. Carr, *et al.* (1983) estimates that sediment removal and disposal for wet detention ponds in the Milwaukee area range from about \$135 to \$150 per acre of watershed served per year, depending on final disposal method (landfilling or land spreading). These costs ranged from about \$5 to \$25 per cubic yard (averaged \$14). The differences in costs were associated with the sizes and accessibilities of the ponds. Small ponds (less than about 1/2 acre in size) had the lowest sediment removal costs of about \$5 to \$10 per cubic yard because front end loaders could be used after pond de-watering. Larger ponds required the use of much more expensive draglines or hydraulic dredges. If on-site disposal was not available, hauling and final disposal costs substantially added to these removal costs. Hauling costs added another \$5 to \$10 per cubic yard, depending on the distance, and landfilling tipping fees could add another \$15 to \$25 per cubic yard to these costs. Therefore, in order to minimize sediment removal and disposal costs, Schueler (1986) stressed the need to provide adequate access to ponds, to provide small pre-sedimentation forebays near the inlets, to provide a drain in smaller ponds to allow complete de-watering, and to provide for on-site disposal of sediment near the pond (for at least two dredgings).

Typical wet detention pond construction costs, excluding land acquisition costs, are estimated to be about \$40,000 per acre of pond. Maintenance costs (including periodic dredging) are estimated to be about four percent of this initial construction cost per year, or about \$1500 per acre of pond per year (1978 costs) (EPA 1983). Initial construction costs (excluding land costs) for a pond sized to achieve about 90 percent suspended solids reductions in a medium density residential area would be about \$300 per watershed acre, with annual maintenance costs of about \$12 per watershed acre. For a pond to achieve the same level of performance in an industrial area, the initial construction costs (again excluding land costs) would be about \$800 per watershed acre, with annual maintenance costs of about \$30 per watershed acre.

## **Guidelines To Enhance Pond Performance**

The Natural Resources Conservation Service (NRCS, renamed from SCS, undated) has prepared a design manual that addresses specific requirements for such things as anti-seep collars around outlet pipes, embankment widths, type of fill required, foundations, emergency spillways, etc., for a variety of wet detention pond sizes and locations. That manual must be followed for detailed engineering requirements.

The rest of this discussion presents some of the many design suggestions that have been made by researchers having many years of design and monitoring experience with detention ponds. Akeley (1980) listed several modifications that can be made to existing ponds to improve their performance. Gravel, or cement, should be added along unstable banks and near the inlet and control structures. A baffle should be placed at the inlet to reduce turbulence, and barriers can be used to separate the pond into compartments to reduce short-circuiting. On-going maintenance is also needed to remove deposited sediment. Hawley, *et al.* (1981) also recommended similar design considerations. Hey and Schaefer (1983) found that a submerged dam near the pond inlets significantly reduced the area requiring maintenance dredging.

Lettenmaier and Dally (1983) stress the importance of source control of pollutants. As an example, for vehicle service areas, they suggest that reviews should be made of all maintenance operations that use detergents, oils and grease, solvent, and hydraulic fluid to minimize their discharge into the drainage system. Fuel storage and transfer operations need to be carefully conducted to minimize fuel spillage, and waste washwater should not be allowed to be discharged into the stormdrain system. Pitt and McLean (1986) also found large amounts of toxic pollutants in runoff flows from many source areas in an industrial area in Toronto. Most of these toxic pollutants were in soluble forms and would not be effectively removed by wet detention. It was obvious that much of these materials were being inappropriately discharged to the stormdrain system during both wet and dry weather. Careful investigations should therefore be made in areas discharging high concentrations of problem pollutants to identify their sources in order to eliminate their discharges at their source areas instead of assuming that outfall treatment is best or even possible.

### ***Insect Control and Fish Stocking***

Mosquito problems at wet detention ponds are increased when large water level fluctuations occur, especially when vast amounts of aquatic plants are wetted and available for egg laying. If ponds drain to normal water levels within several hours after a rain has ended, if aquatic vegetation is kept to a minimum (such as only along a narrow ledge close to shore), and if the pond shape allows adequate water movement and wind disturbance, then mosquito problems should be minimal.

Schimmenti (1980) made several recommendations to reduce the possibility of mosquito problems in detention ponds. Wet ponds should have adequate water quality to support surface feeding fish, such as sunfish, and various minnows, that feed on mosquitoes. Carp or crayfish also make adequate biological controls for midges, reducing the need for chemical controls (Ontario 1984).

Some developers have tried to stock trout, yellow perch, and northern pike in detention ponds, but no reproduction and poor wintering soon eliminates these less tolerant fish. Detention ponds receiving urban runoff are likely to contaminate fish, making them unsuitable for consumption. Brydges and Robinson (1986) have conducted extensive heavy metal and pesticide analyses in fish in two wet detention ponds near Toronto, Ontario and have found little problem accumulations of these substances. However, many other studies have reported problem toxic pollutant concentrations in fish from waters receiving urban runoff, so allowing fish consumption in wet detention facilities should only be allowed after careful study. Therefore, game fish should not generally be used in ponds, and consumptive fishing should be discouraged. Fathead minnows, stocked for mosquito control, have survived in detention ponds in Ontario.

### ***Aquatic Plants for Detention Ponds***

Aquatic plants are used in many ways in detention ponds, including providing increased nutrient and other soluble pollutant removals, competition with nuisance plants, aquatic life habitat, physical barriers, and decorative



landscaping elements. Obviously, care needs to be taken when selecting aquatic plants to ensure that the plants will support the desired objectives and be compatible with multiple objectives and the local growing conditions. It is best to consult professional aquatic plant specialists to determine the best species for each project.

Rooted aquatic plants should be planted along much of the shallow perimeter shelf to deter small children, for aesthetics and to provide wildlife habitat. The use of native aquatic plants is to be encouraged to lessen maintenance costs and to prevent nuisance plants from becoming established in a waterway (such as purple loosestrife). Plants that could be established in wet detention ponds include arrowhead and cattails. Cattails sometimes interfere with the operation of a surface outlet because of large floating pieces clogging the weir. Subsurface weirs and trash racks (both recommended) would reduce this problem. Many rooted aquatic plants may be used in wet detention ponds, but their selection and planting should be done in consultation with landscape architects and wildlife biologists. Fuhr (1996) warns against planting trees and brush on an impoundment because seepage problems may result by root action.

An interesting use of aquatic plants to enhance wet detention pond performance was described in the February 1991 *Lake Line*. Nutri-Pods, developed by the Limnion Corporation of Concord, CA, are two m diameter mesh balls, initially filled about 25% full with coontail (*Ceratophyllum demersum*). One to five Nutri-Pods are used per acre of pond surface, for ponds at least one acre in size. These reduce nutrient concentrations in the water and successfully compete with other aquatic plants, including planktonic algae. They were tested on a 27 acre lake near Sacramento, CA, which underwent periodic major increases in nutrients (phosphates as high as 50 mg/L) from fertilizing on the surrounding land. It took about two to four weeks for the Nutri-Pods to stabilize the lake after each major increase. Adding *Elodea* to the Nutri-Pods helped to keep nutrient concentrations very low (phosphorus at about 0.01 mg/L and nitrates less than 0.1 mg/L). The Nutri-Pods are inspected every few weeks and when they approach 100% capacity with the internal aquatic plants, they are removed from the water, and plants are removed, except for about 25% which are used as a starter. The Nutri-Pods therefore use aquatic plants to improve wet detention pond water quality, while enabling controlled harvesting with very little specialized equipment.

Planting wetland plants in artificial wetlands for stormwater control doesn't always determine the mixture of plants that will become established in the long term. Wind (1996) describes a site that was seeded with perennial rye, plus five wetland plants. After about three years, the site appeared to have a cattail monoculture, although no cattails were originally planted, nor were any apparent in the project vicinity. Upon surveying the site, a much greater diversity of healthy plants was found, though few were included in the initial seed mixture. Wind concluded that the inhabiting plants were successful because of their suitability to the site and natural invasion was perhaps the best end result. The initial seed mix should probably be considered a mechanism for erosion control and as "nursery" plants, giving invading natural species protection. However, invading nuisance plants should be controlled.

Tables 2 and 3 are examples of aquatic plants available from two different sources for upper midwest ponds and extreme southeast ponds. Table 2, from J.P. Ludwig (Ecological Research Services, The Academy Center, Bay City, MI 48708), is a cold region native wet site plant list for a seed mixture that was available in 1987. This seed mixture was suited for saturated, moist, or flooded sites, (especially for clay or loamy organic soils) including pond edges.

**Table 2. Northern Native Seed Mixture for Wetlands**

<i>Agrimonia gryposepala</i>	Agrimony
<i>Amemone canadensis</i>	Windflower
<i>Apocynum cannabinum</i>	Indian hemp
<i>A. medium</i>	Indian hemp
<i>Asclepias incarnata</i>	Swamp milkweed
<i>Aster drummondii</i>	Aster
<i>A. novae-anglae</i>	New England aster
<i>A. pilosus</i>	Aster
<i>A. umbellatus</i>	Aster
<i>Bidens cernua</i>	Begger tick
<i>B. frondosa</i>	Begger tick
<i>Carex sparganioides</i>	Sedge
<i>C. Tenure</i>	Sedge
<i>Cephalanthus occidentalis</i>	Buttonbush

<i>Cirsium muticum</i>	Swamp thistle
<i>Convolvulus sepium</i>	Bindweed
<i>Cornus racemosa</i>	Grey dogwood
<i>C. stolonifera</i>	Red-osier dogwood
<i>Cyperus strigosus</i>	Galingale
<i>Epilobium angustifolium</i>	Fireweed
<i>E. hirsutum</i>	Willow-herb
<i>Eurpatorium maculatum</i>	Joe-Pye weed
<i>E. perfoliatum</i>	Boneset
<i>E. purpureum</i>	Purple Joe-pyeweed
<i>Gentiana andrewsii</i>	Bottle gentian
<i>G. crinita</i>	Fringed gentian
<i>G. procera</i>	Gentian
<i>Geum laniciatum</i>	Avens
<i>Glyceria canadensis</i>	Mannagrass
<i>Helianthus giganteus</i>	Giant sunflower
<i>H. grosseratus</i>	Sawtooth sunflower
<i>H. tuberosa</i>	Jerusalem artichoke
<i>Helinium antumnae</i>	Sneezeweed
<i>Iris versicolor</i>	Iris
<i>Juncus sp.</i>	Rush
<i>Leersia orizoides</i>	Sawgrass
<i>Lilium michiganese</i>	Michigan lily
<i>L. supurbum</i>	Turk's-cap lily
<i>Lobelia cardinalis</i>	Cardinal flower
<i>Lycopus americanus</i>	Water horehound
<i>Menaspermum canadensis</i>	Moonseed
<i>Onoclea sensibilis</i>	Sensitive fern
<i>Rosa palustris</i>	Swamp rose
<i>Rudbeckia fulgida</i>	Black-eyed Susan
<i>R. hirta</i>	Black-eyed Susan
<i>R. subtomentosa</i>	Black-eyed Susan
<i>R. triloba</i>	Black-eyed Susan
<i>Sagittaria latifolia</i>	Arrowhead
<i>Scirpus americanus</i>	Bulrush
<i>Siphium terebinthinaceum</i>	Prairie dock
<i>Solidago graminifolia</i>	Grass-leaved goldenrod
<i>Spiraea tomentosa</i>	Hardhack
<i>Thelypteris palustris</i>	Swamp fern
<i>Verbena hastata</i>	Vercaïn
<i>Vernonia altissima</i>	Tall ironweed

Source: Ecological Research Services, Bay City, MI

**Table 3. Aquatic Plants Currently Utilized in Florida Aquascaping Projects**

Upper Zone

Sand cordgrass	<i>Spartina bakeri</i>	(+0.5' to 0')
Soft rush	<i>Juncus effusus</i>	(0' to -0.5')
Golden canna	<i>Canna flaccida</i>	(+0.5' to -0.5')
Blue flag iris	<i>Iris virginicus</i>	(+0.5' to -0.5')
Bulrush	<i>Scirpus validus</i>	(0' to -0.5')

Middle Zone

Pickerelweed	<i>Pontederia cordata</i>	(-1' to -3')
Arrowhead	<i>Sagittaria lancifolia</i>	(-1' to -3')

Lower Zone

Fragrant white water lily	<i>Nymphaea odorata</i>	(-3' to -5')
Strap leaf sagittaria	<i>Sagittaria subulata</i>	(-1' to -3')

Source: Aurora, Inc., FL

Table 3 is a 1988 native plant list for extreme southeast wetlands from W. Miller (Aurora Incorporated, Florida). Aurora Inc. has assisted in the “aquascaping” of a number of freshwater Florida stormwater management ponds. Table 3 indicates specific plants for different water depths (such as for the subsurface ledge that would include upper and middle zone plants, and pond edges that would include the upper zone plants).

Figures 9 and 10 are maps showing the distribution of the growing season for common wetland plants used for water treatment. In much of the country, the growing season is 6 months, or less, for these plants. There remain serious questions concerning the ability of wetland plants to retain pollutants during their dormant season. Stormwater control with wetland vegetation is more restricted than sanitary sewage because it is not warm during winter months. Sanitary sewage is warmer than ambient temperatures which can significantly extend the growing season. The high chloride concentrations in snowmelt and early spring runoff may be especially harmful to wetland plants. Without deep pools of water (at least 3 feet), scour may also be a serious problem. It is recommended that wetland systems be used as polishing systems after wet detention ponds for use only during their active growing season. Most flows should be diverted around the wetlands during critical periods (especially dormant periods) to prevent scour. Moderate amounts of plant growth in wet detention ponds, especially along the edge on the shallow shelf, however, should be used.

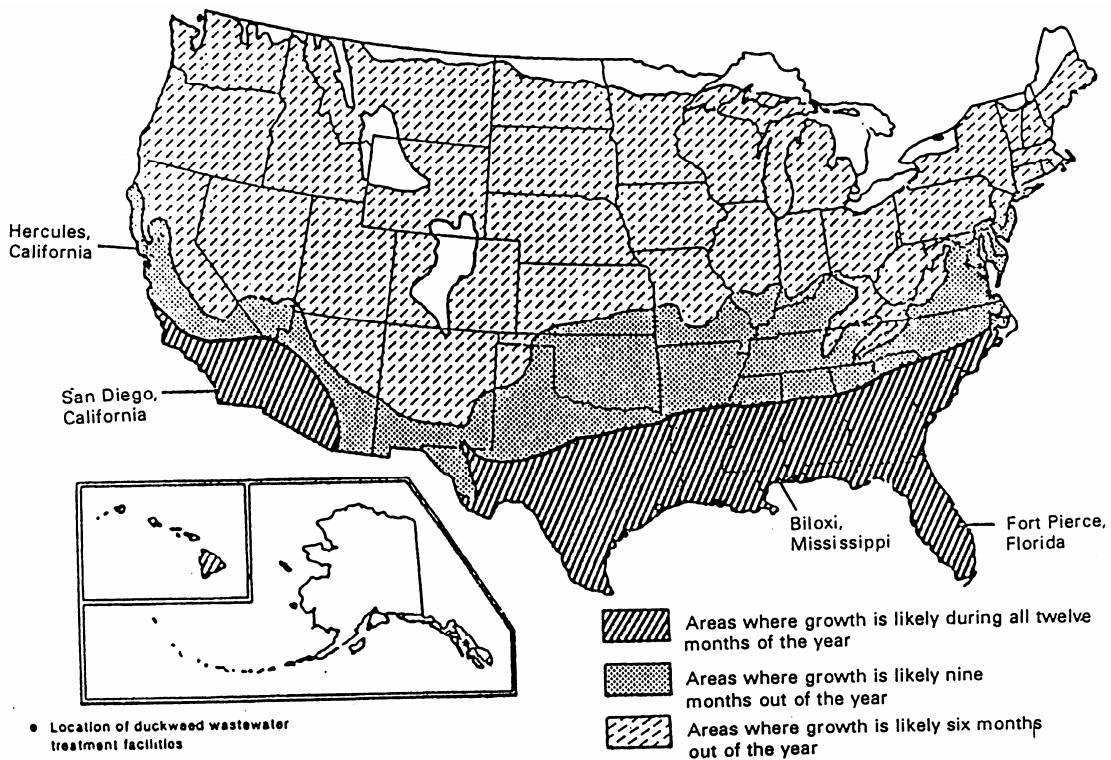

Figure 9. Potential growth distribution for duckweed in the U.S. (Reed, et al. 1988).

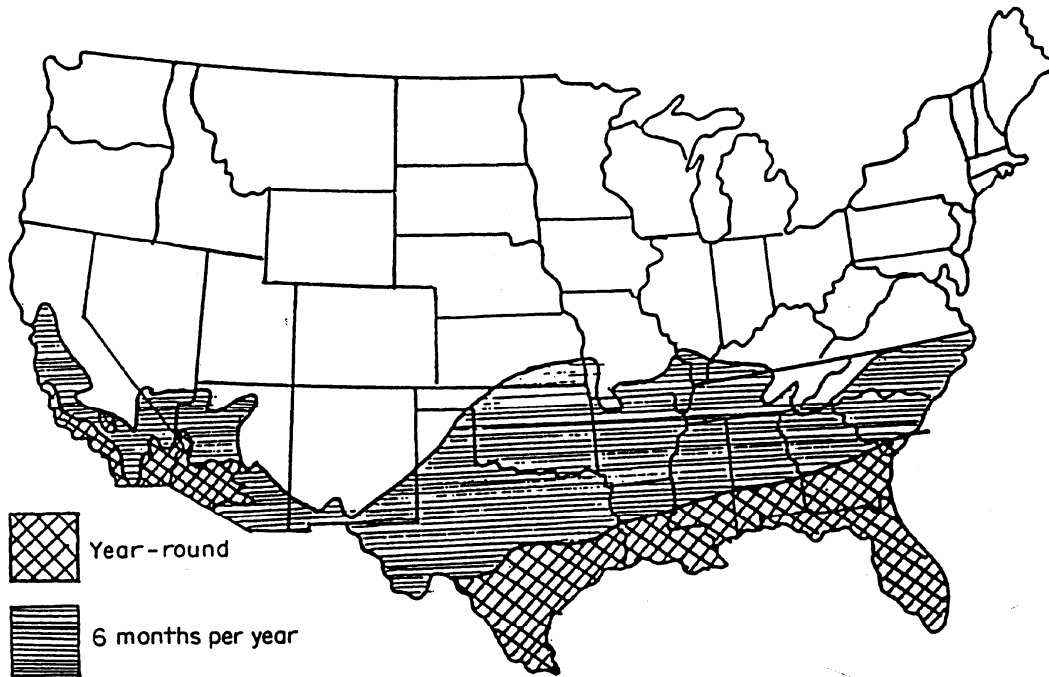

Figure 10. Suitable areas for hyacinth wetland systems (Reed, et al. 1988).

Figure 11 is a cross-section of a Lemna pond (an engineered stabilization pond for sanitary sewage treatment, supplemented with aquatic plants), showing the processes that are available for pollutant removal in a biological system, supplementing the physical processes. Tables 4 through 6 also show the added benefits that biological systems can provide in ponds.

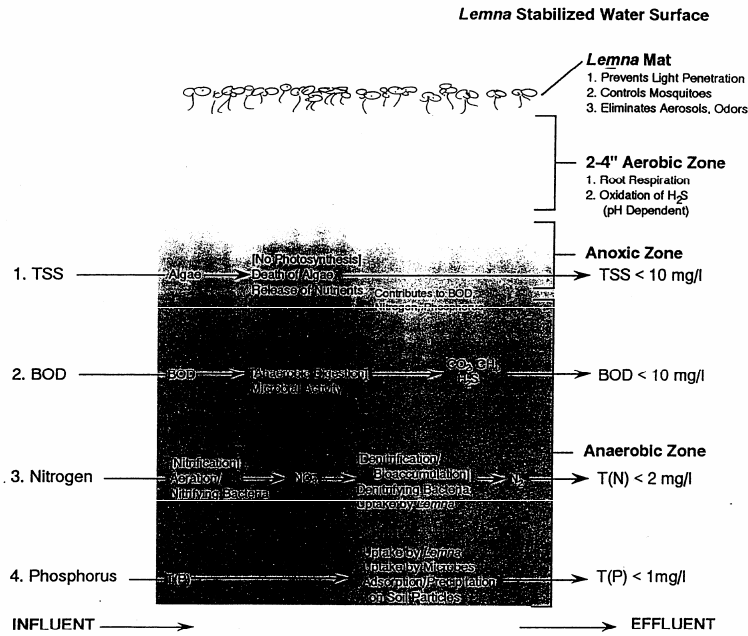

Figure 11. Water treatment processes available in wetland treatment system (Lemna System, undated).

**Table 4. Fish Species used in wastewater Treatment (Reed, et al. 1988).**

Common name, <i>scientific name</i>	Pond location	Feeding habits
Silver carp, <i>Hypophthalmichthys molitrix</i>	Upper layers	Phytoplankton
Bighead carp, <i>Aristichthys nobilis</i>	Upper layers	Phytoplankton, zooplankton suspended solids
Black carp, <i>Mylopharyngodon piceus</i>	Bottom	Snails, crustaceans, mussels
Grass carp, <i>Ctenopharyngodon idella</i>	Ubiquitous	Variable
Common carp, <i>Cyprinis carpio</i>	Bottom	Phytoplankton, zooplankton, insect larvae
Tilapia, <i>Tilapia</i> spp., <i>Sarotherodon</i> spp.	Ubiquitous	Plants, plankton, detritus, invertebrates
Catfish, <i>Ictalurus</i> spp.	Bottom	Crustaceans, algae, fish insect larvae
Fathead minnows, <i>Pimephales promelas</i>	Bottom	Phytoplankton, zooplankton invertebrates
Golden shiner, <i>Notemigonus crysoleucas</i>		
Mosquito fish, <i>Gambusia affinis</i>	Surface	Insect larvae, zooplankton, algae
Buffalofish, <i>Ictiobus</i> spp.	Bottom	Crustaceans, detritus, insect larvae

**Table 5. Contaminant Removal Mechanisms Available in Wet Detention Ponds (Hammer 1989).**

Mechanism	Contaminant Affected <sup>a</sup>	Description
<b>Physical</b>		
Sedimentation	P - Settleable solids S - Colloidal solids I - BOD, nitrogen, phosphorus, heavy metals, refractory organics, bacteria and virus	Gravity settling solids (and constituent contaminants) in pond/marsh settings.
Filtration	S - Settleable solids, colloidal solids	Particulates filtered mechanically as water passes through substrate, root masses, or fish.
Adsorption	S - Colloidal solids	Interparticle attractive force (van der Waals force).
<b>Chemical</b>		
Precipitation	P - Phosphorus, heavy metals	Formation of or coprecipitation with insoluble compounds.
Adsorption	P - Phosphorus, heavy metals S - Refractory organics	Adsorption on substrate and plant surface.
Decomposition	P - Refractory organics	Decomposition or alteration of less stable compounds by phenomena such as UV irradiation, oxidation, and reduction.
<b>Biological</b>		
Microbial metabolism <sup>b</sup>	P - Colloidal solids, BOD, nitrogen, refractory organics, heavy metals	Removal of colloidal solids and soluble organics by suspended, benthic, and plant-supported bacteria. Bacterial nitrification/denitrification. Microbially mediated oxidation of metals.
Plant metabolism <sup>b</sup>	S - Refractory organics, bacteria, and virus	Uptake and metabolism of organics by plants. Root excretions may be toxic to organisms of enteric origin.
Plant absorption	S - Nitrogen, phosphorus, heavy metals, refractory organics	Under proper conditions, significant quantities of these contaminants will be taken up by plants.
Natural dieoff	P - Bacteria and virus	Natural decay or organisms in an unfavorable environment.

Source: Stowell et al.<sup>14</sup>

<sup>a</sup>P = primary effect; S = secondary effect; I = incidental effect (effect occurring incidental to removal of another contaminant).

<sup>b</sup>Metabolism includes both biosynthesis and catabolic reactions.

**Table 6. Potential Uptake Rates of Lemna System (Lemna System, undated)**

<u>Elements</u>	<u>Uptake Rate lbs/acre/year</u>
Phosphorus	700
Nitrogen	5,450
Iron	710
Chloride	940
Sulfur	580
Sodium	350
Potassium	2,250
Calcium	5,000
Copper	2
Zinc	6
Manganese	80
Magnesium	700
Chromium	5
Aluminum	2,300
Arsenic	5
Mercury	1

### ***Locating Ponds***

Ponds that require limiting access, because of uncontrollable nuisance conditions, can be more easily located in industrial or commercial sites (Chambers and Tottle 1980). Ponds offering non-contact recreation and non-consumptive fishing (such as small boat use, ice skating, and aesthetic enjoyment) must be better maintained because of their visibility and need to be located for easy access. As noted in the following paragraphs, basin-wide hydraulic analyses must be used in developing watersheds to identify the best locations for detention ponds to be used for peak flow rate control.

Locating detention ponds close to the sources of the pollutants usually requires the use of many small ponds. Maintenance and cost considerations, however, usually dictate the use of a smaller number of larger detention ponds. In the Washington, D.C. area, detention ponds are discouraged for service areas less than 25 acres (Wiegand, *et al.* 1986). The largest service areas usually treated with wet detention ponds in the Washington, D.C. area are about 400 acres. This service size range (25 to 400 acres) translates to effective pond surface areas of about 1/4 to 12 acres.

Stormwater wet detention ponds for water quality benefits should be carefully located, considering critical source areas and the use of other control practices. Placement of stormwater detention ponds on the mainstems of receiving waters is not recommended because of the large drainage area upstream that must be considered in the design and the difficulty of effectively using additional controls upstream. Retro-fitting detention ponds in existing areas requires a different approach than for new construction. In retro-fitting controls, detailed watershed analyses are



needed to identify outfalls of drainages that contribute significant discharges and upland locations near critical sources (such as industrial and commercial areas), all in conjunction with other possible controls that can be applied simultaneously. They shouldn't be arbitrarily used at all outfalls.

For new construction, wet detention ponds are needed in areas that have large pollutant potentials and where infiltration controls can not be used because of possible groundwater contamination. Large parking or storage areas (paved or unpaved) greater than one acre in size need on-site wet detention ponds to serve as pre-treatment devices before infiltration. Smaller areas may be better served with large catchbasins and oil and grease traps, or sand filters, as infiltration pretreatment. Shopping centers are the most significant example of these areas. Additionally, industrial areas greater than about three acres need to be served with on-site wet detention ponds, with no infiltration. Large residential areas, especially if having high density single family or multi-family units, could also effectively use wet detention ponds as part of the landscaping plans to supplement the infiltration program.

Special consideration is needed for areas or developments that are likely to produce significant water volume or pollutant discharges. Large roofs produce substantial portions of the total runoff volumes from commercial and many industrial areas. Roof runoff is relatively unpolluted, however, except for high zinc concentrations from galvanized roof drainage systems. Paved parking and storage areas also produce large volumes of runoff, and this water can be heavily polluted, especially in manufacturing or heavy industrial areas. While infiltration of roof runoff from large roofs can produce significant water volume reductions, it cannot be used when roof runoff may be contaminated, as may occur in manufacturing industrial areas. Where groundwater contamination is likely (such as when the groundwater is close to the surface or in sandy soils) (Pitt, *et al.* 1994; 1996), wet detention basins (or grit chambers with oil and grease traps for small areas) may be the best control device.

The following list shows which specific controls should be considered for large source areas:

- Roofs should direct the roof runoff to infiltration devices, depending on groundwater conditions.
- Medium parking lots and storage areas, having areas between 5,000 to 500,000 square feet should direct this runoff to grit chambers and then to infiltration devices. If groundwater conditions prevent the use of infiltration devices, then wet detention ponds need to be used.
- Large parking lots and storage areas, having areas greater than 500,000 square feet, should use wet detention basins before infiltration devices (such as percolation ponds). Groundwater conditions may prevent the use of infiltration devices.
- Industrial sites greater than 100,000 square feet need to pretreat their runoff in wet detention ponds before discharge. Additional treatment may be needed for all industrial areas.

It is usually easier to inspect (and maintain) a small number of relatively large facilities, and larger wet detention basins offer greater public use (such as noncontact recreation and nonconsumptive fishing, for example). Industrial areas or large shopping areas pose an important exception to large, regional detention basins. Public water contact in industrial area wet detention basins should be discouraged because they have very poor water quality. Industrial discharges should also be kept separated in their own detention basins to optimize any special controls that may be needed.

Stormwater control devices can be applied to storm drainage inlets and storm sewerage, besides at critical areas. These may include infiltration devices, perforated underground storm drainage systems, roadside grass swales, or catchbasin cleaning. Outfall controls also may include many options, but the two most efficient are infiltration devices (percolation ponds) and wet detention basins.

Industrial areas have been found to produce very large portions of the total urban runoff wasteload in cities, especially of heavy metals and toxic organics. Unfortunately, much of this material is discharged during dry weather, possibly as part of wash operations or minor spills. Wet detention basins at the outfalls of industrial developments are needed to control runoff from the industrial sites and to offer an opportunity to remove any dry weather industrial spills and discharges. Reported spills that enter the stormwater drainage system in industrial areas may also be contained for cleanup in outfall wet detention basins. Installation of detention basins during the early

phases of a construction project (before the drainage system is installed) can significantly reduce sediment transport from a construction site to receiving waters.

Many stormwater control options can be used together very well. Infiltration trenches, for example, can treat runoff from rains having relatively low intensities but long durations (and therefore large rain volumes). Infiltration devices also remove most pollutants and flow volume from the runoff. However, they discharge these pollutants to the soil and groundwater systems, requiring careful consideration. In all cases, local groundwater contamination potential must be evaluated to reduce the probability of contaminating groundwater with stormwater infiltration. Detention basins, on the other hand, work well with high intensity, low volume rains, but do not reduce soluble forms of the pollutants or flow quantities. These two devices can be used together to treat many runoff pollutants for a wide range of rain conditions.

Rosmiller (1987) notes that the location and amount of detention pond storage in relation to the size of the watershed is important in determining the peak flow rate reduction potential of a pond. He found that large ponds on the mainstem of a stream and on its major tributaries result in greater reductions in peak flow rates than numerous smaller ponds spread throughout the watershed. Unfortunately, this can conflict with water quality and biological objectives in areas upstream of a mainstem detention pond. He concludes that the best peak flow rate reductions in downstream portions of a watershed are associated with detention ponds located in the middle portions of a watershed. Detention ponds located on tributaries in the downstream portions of watersheds can increase peak flows in the mainstem because of the superposition of peak flows from upper portions of the watershed and the peak flows from delayed hydrographs from the downstream detention ponds.

Figures 12 through 14, from Rosmiller (1987), illustrate how detention pond locations can greatly influence the resultant peak flow rates. Figure 12 shows a watershed with a downstream urbanizing tributary. Figure 13 shows the predevelopment (and pre-detention) tributary, mainstem, and combined hydrographs for this watershed. Figure 14 shows how a tributary detention pond located downstream of the urbanizing area maintains the predevelopment peak runoff rate for the tributary, but results in substantially greater combined flows downstream after combining with the mainstem hydrograph.

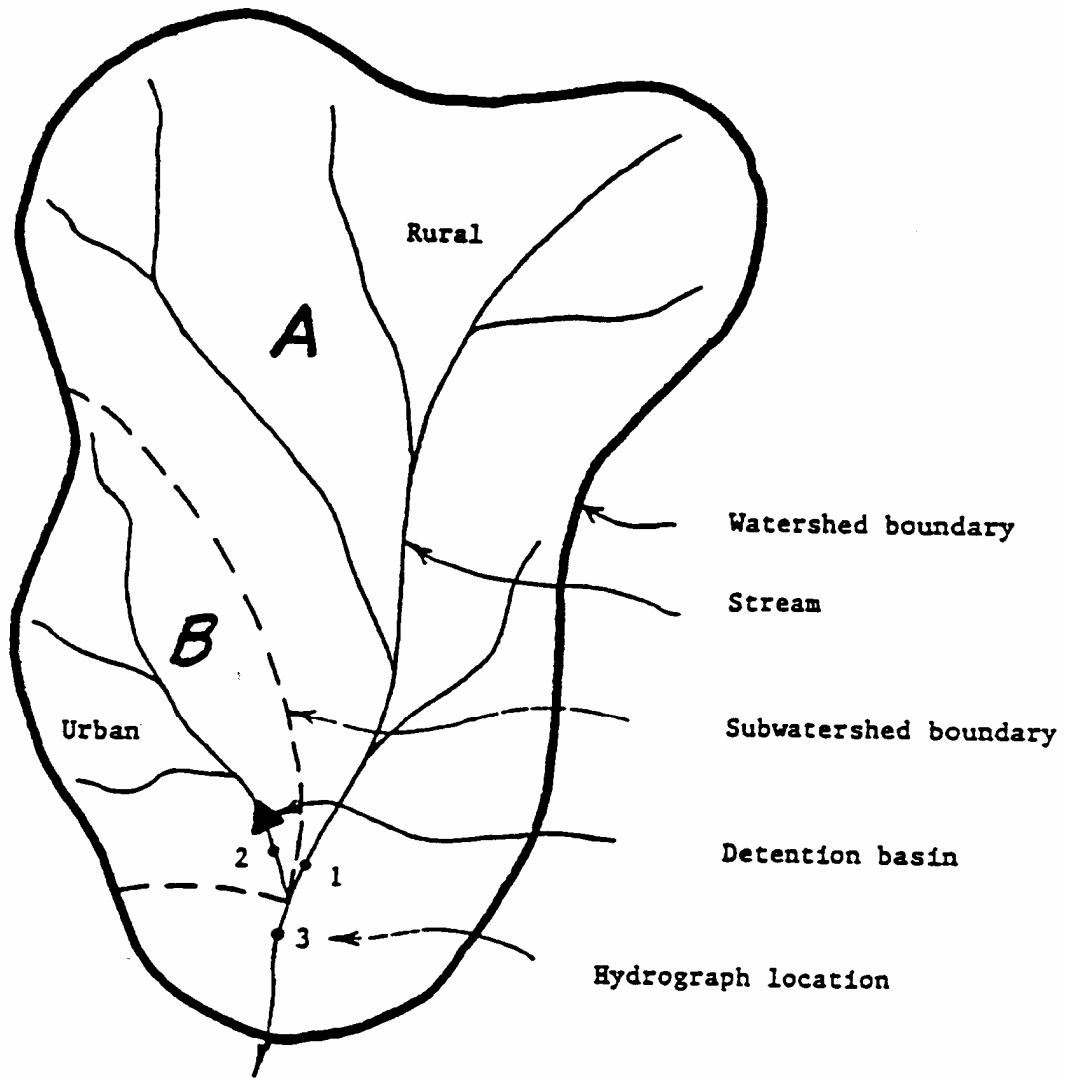

Figure 12. Detention pond located in downstream portion of watershed (Rosmiller 1987).

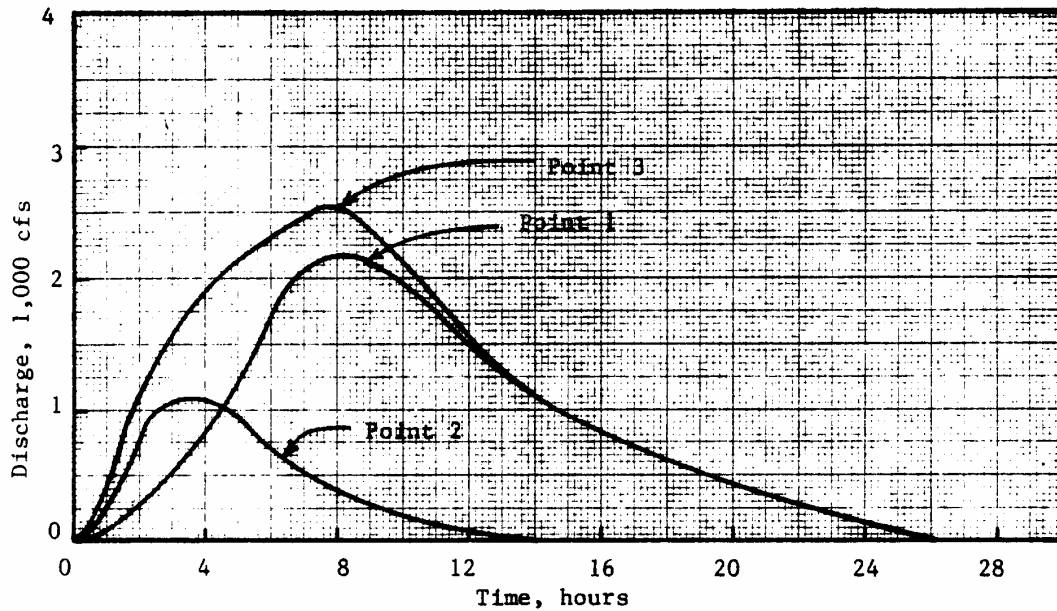

Figure 13. Hydrographs before urbanization without detention (Rosmiller 1987).

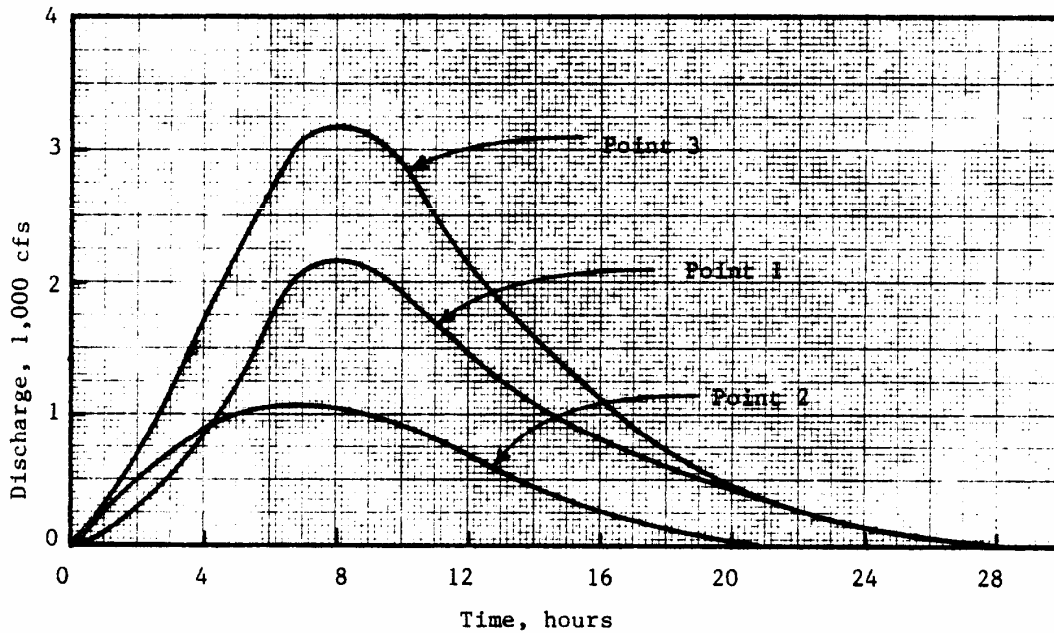

Figure 14. Hydrographs after urbanization with downstream detention (Rosmiller 1987).

A detention pond does not reduce the runoff volume, but can only delay the discharge of the runoff. Urbanization results in both increased peak runoff rates and runoff volume. Detention can radically alter the shape of a hydrograph (and therefore the peak runoff rate) but it cannot reduce the runoff volume. If the peak runoff rate is

reduced, and no volume reduction occurs (such as from infiltration practices) then the hydrograph base must be expanded. This expanded base hydrograph, if from a downstream area, can interact with the naturally delayed portions of upstream hydrographs (assuming the rain duration was less than the total watershed time of concentration).

Rosmiller (1987) also states that similar problems may occur with detention facilities randomly located throughout a watershed. This can be caused by stormwater ordinances requiring detention facilities located at each development site that are to preserve pre-development peak runoff rates. He points out that detention ponds for peak flow rate objectives must be carefully located to minimize these interferences. He explains that effective stormwater management to obtain peak flow rate objectives must be met using a combination of regional ponds on the main stem and major tributaries for main stem protection and smaller on- and off-site ponds for local area protection. Rosmiller's (1987) three steps to minimize peak flow increases with interfering hydrographs from multiple ponds are as follows:

“1. Locate the regional ponds first and determine the volume of storage needed to obtain the attenuation needed to reduce future peak flows to pre-development peaks.

2. Address each watershed upstream of each regional basin in turn to determine where supplemental ponds are needed to give protection to the inhabitants and property in each watershed.

3. Design these localized on- and off-site ponds plus the regional pond for that watershed in concert with each other so that the overall effect is achieved.”

### ***Pond Surface Area and Shape***

Surface area is one of the most important design considerations for particle removal. Surface area is also important if the pond is to be used for recreational purposes. A minimum pond size of about five acres is necessary for a pond to have much recreation value for anything but ice skating (Ontario 1984). Large pond volumes also reduce the chance of a rain displacing all of the pond volume and increases the residence times of the water for further water quality improvement (Hey and Schaefer 1983).

Hittman (1976) reports that pond length to width ratios of about five have produced maximum pond efficiencies (decreased short-circuiting) during dye tests. If a long and narrow pond cannot be constructed, Schueler (1986) suggests that baffles or gabions be placed within the pond to lengthen the flow path between the inlets and outlets. Bondurat, *et al.* (1975) has also suggested that the idealized pond shape would be triangular: narrow near the inlet and wider near the outlet. This triangular configuration would allow more efficient particle settling by having a continually decreasing forward velocity. Very irregular pond shapes may decrease circulation and cause localized nuisance problems. The pond shape should be irregular for aesthetic considerations, but with minimal opportunities for water stagnation.

### ***Pond Water Depth***

Chambers and Tottle (1980) state that pond water depth affects algae growth, aquifer contamination, water stratification, fish survival, sedimentation, and flood control. A storage volume above the permanent pool elevation of the pond affects the pond's ability to absorb excess flows for flood control. Harrington (1986) found that increasing the wet pool depth increases sedimentation efficiency (due to flocculation), but that surface area increases were much more effective in enhancing the water quality performance of wet ponds. A minimum wet pool depth is very critical in wet ponds to decrease scour losses of previously settled material. Without an adequate permanent pool depth, very little water quality benefits can be expected from wet ponds.

The NRCS (SCS 1982) recommends a pond depth of at least six or seven feet in agricultural areas to insure adequate water during dry periods. In urban areas, the runoff water yield per acre is substantially greater than in agricultural areas, and the depth could probably be less. However, in urban areas containing substantial infiltration devices (such as grass swale drainage ditches) this deeper depth may be needed.

To reduce widespread attached aquatic plant growth problems, a pond depth of at least four feet is recommended. This depth will generally prevent the growth of attached aquatic plants in clean ponds. Similarly, shallower pond depths are needed in areas where attached aquatic plants are wanted, such as along much of the recommended

perimeter shelf of wet ponds. Schueler (1986) reports that many emergent plants require water depths of less than six inches, while submerged plants typically require water one to two feet deep. Deep ponds will therefore restrict plant growth. A water depth of about six feet over the major portion of the pond will also increase winter survival of fish.

Extra pond depth needs to be considered for sediment storage between removal operations (Schimmenti 1980). Wiegand, *et al.* (1986) state that it costs about five times as much to remove sediment during pond dredging operations (about \$14 per cubic yard) as it does to provide extra sediment storage capacity (sacrificial volume) during initial pond construction (about \$3 per cubic yard). This sacrificial storage should be provided as deeper forebays near the pond inlets (Driscoll 1986). These forebays, or the use of underwater dams, need to be designed as pre-sedimentation traps to encourage the deposition of sediment in a relatively restricted area. This would result in more frequent sediment removal operations, but at a much lower cost.

Sufficient water depth (at least three feet over the maximum deposited sediment thickness) is also needed to decrease the potential of sediment scour caused by increased flows during large storms (EPA 1983). Hey and Schaefer (1983) found that a depth of five feet was sufficient to protect the unconsolidated sediment from resuspension in Lake Ellyn. Deep isolated pools should also be discouraged as they will tend to accumulate poor sediment and water quality (Free and Mulamootil 1983 and Wigington, *et al.* 1983). Schueler (1986) also recommends against ponds with average depths greater than six to eight feet to prevent water stratification and associated water quality and fish survival problems.

### ***Pond Side Slopes***

Reported recommended side slopes of detention ponds have ranged from 1:4 (one vertical unit to four horizontal units) to 1:10. Steeper slopes will cause problems with grass cutting and may erode. Steep slopes are not as aesthetically pleasing and are more dangerous than gentle slopes (Chambers and Tottle 1980). Schueler (1986) also recommends a minimum slope of 1:20 for land near the pond to provide for adequate drainage.

The slope near the waterline, and for about one foot below, should be relatively steep (1:4) to reduce mosquito problems (by reducing the amount of frequently wetted land surface), and to provide relatively fast pond drawdown after common storms. However, a flat underwater shelf several feet wide and about one foot below the normal pond surface is needed as a safety measure to make it easier for anyone who happens to fall into the pond to regain their footing and climb out. This shelf should also be planted with native rooted aquatic plants (macrophytes) to increase the aesthetics and habitat benefits of a pond and to create a barrier making unwanted access to deep water difficult.

Another method of treating pond edges is placing gravel along the pond edge to decrease erosion and to make mowing easier (Chambers and Tottle 1980). This method requires placing a layer of gravel about one foot deep and 15 feet wide along the pond edge, from about ten feet above the normal waterline edge and extending about five into the water.

### ***Internal Baffles***

The use of baffles within ponds has been shown to significantly increase detention pond performance (Hittman 1976). Baffles increase the travel distance of the water (increase the length to width ratio) and reduce short-circuiting. Particle removal is therefore closer to what is theoretically predicted.

### ***Outlet Structures***

Most of the effort given to alternative outlet structure designs has been for dry detention ponds. Wet ponds usually only have a surface weir, outlet pipe, or other simple overflow device to allow the passage of displaced pond water during rains. With the use of a more sophisticated outlet device, located at the normal wet pond surface elevation, more efficient particulate removals and flood control benefits may occur.

Hittman (1976) recommends that wide outflow (and inflow) channels be used to decrease erosion. If wide flow channels are not possible, then energy dissipaters to reduce the water velocity should be used. The Natural Resources Conservation Service (was SCS 1982) has prepared design guidelines for outlet structures for wet detention ponds. These guidelines include a turf covered embankment having a trapezoidal cross section, a pipe

passing through the embankment as the major outlet with a metal riser and upstream trash rack, and an emergency spillway.

Controlled emptying of a detention pond at low outlet flow rates is desirable for effective sediment removal and flood control. A small diameter outlet pipe, or a small orifice on a plate, is usually used to achieve low outflows. The rate of discharge varies for these outlets because of varying overlying water levels. High flow rates occur with higher water levels and the outlet flows decrease with falling water levels. Selecting an appropriate outlet structure has significant effects on pond performance. To have a constant pond performance for all events (if desired), the shape of the outlet must allow a constant upflow velocity (pond outflow rate divided by pond surface area).

If water temperature increases are expected to be a problem, then subsurface outlets may be needed. Subsurface outlets also minimize trash fouling of the outlet. One method of achieving subsurface discharges is to use a submerged large diameter pipe (the pipe bottom must still be at least three feet off of the pond bottom to minimize sediment scour) discharging to a control box that contains the outlet weir (such as a v-notch weir) whose invert is above the top of the pipe.

Mason (1981) states that the benefits of regulating runoff from the frequent less intense storms are usually overlooked. Smaller storms produce less runoff per event, but may be heavily contaminated and occur frequently. Outlets having variable opening sizes with depth can be designed to provide some detention of small rains while allowing flood control benefits from the larger storms. V-notch weirs and multi-stage outlets can control both low and high flows and are recommended for general use. These devices need to be located with their lowest openings at the permanent pool water elevation in wet ponds to provide both desired water quality and flood control benefits.

### ***Emergency Spillways***

All detention ponds must also be equipped with emergency spillways. Mason (1982) states that the preferred location of an emergency spillway is on undisturbed ground rather than over a prepared embankment to reduce the erosion potential. Detention ponds treating runoff from small contributing areas can safely handle overflows as sheetflows through well designed swales.

The Natural Resources Conservation Service guidelines for designing runoff control measures must be followed when designing emergency spillways for wet detention ponds. In addition, if the detention pond is large, special regulations of the state and the Army Corps of Engineers must be followed.

### ***Multiple Detention Ponds and their use With Other Control Devices***

Two or more wet detention ponds in series have been used to increase the removal of fine-grained sediment (Hittman 1976). Multiple ponds usually have better removals than a single large pond having the same surface area. Reduced short-circuiting and scouring of sediment usually occurs and maintenance dredging is restricted to the first pond. It is important however that the downstream pond be significantly larger than the upstream pond for improved performance.

Detention ponds can also be appropriately used in conjunction with other control measures. Because detention ponds only affect particulate pollutants, source area infiltration of relatively unpolluted waters may be needed to reduce soluble pollutant discharges. Source area infiltration also reduces the flow volumes that need to be treated by outfall wet detention ponds, allowing size reductions for the ponds or increased performance.

Wet detention ponds can be used as pretreatment devices before infiltration to reduce the potential contamination of groundwater. However, very little soluble pollutants (the pollutants that have greater potential for affecting groundwater) are typically removed by wet detention ponds. They can, however, remove most of the particulates that are likely to clog infiltration devices, greatly extending the life of the infiltration device. Oil and grease traps are essential for wet detention ponds that serve commercial and industrial areas (Dally, *et al.* 1983).

### ***Enhancing Pond Performance During Severe Winter Conditions***

Oberts (1990 and 1994) monitored four urban wet detention ponds during both warm and cold weather in Minnesota. The ponds performed as expected during warm weather, providing typical removals of suspended solids

(80%), lead (68%), and TP (52%). However, he found that the ponds did a much worse job of removing suspended solids (39%), organic matter (12% for COD), nutrients (4 % for TKN to 17% for TP) and lead (20%) in the winter. He found that thick ice, which can form as much as 1 m in thickness, effectively eliminated much of the detention volume for incoming snowmelt water. In addition, the first melting water was forced under the ice, causing scour of the previously sediments. Later snowmelt water flowed across the surface of the ice, with very little sedimentation opportunities. Any sediment that was accumulated on top of the underlying ice was later discharged when the ice melted. Similar research in Minnesota wetlands also showed similar dismal performance during winter conditions, for much the same reasons.

Oberts (1990 and 1994) proposed several improvements in stormwater management during winter conditions. His initial recommendation is to utilize infiltration and grass filtering in waterways before any detention facilities. He found that substantial infiltration can occur, even in clayey soils, underlying the snow. The ground under snowpacks is rarely frozen and infiltration can be significant until the soil becomes saturated. If the snowmelt is originating from areas having automobile activity (streets and parking areas) or sidewalks, care must be taken because the snowmelt likely would have high concentrations of salts which would adversely affect the local groundwater (Pitt, *et al.* 1996). Figure 15 shows a layout of a stormwater treatment facility for northern areas, using grass swales, infiltration areas, and a wetland/detention facility (Oberts 1994). The design of the detention pond should be modified for winter operations. A low flow channel leading to and through the pond will discourage the formation of ice. The pond can also be aerated to prevent ice formation, however, if it gets extremely cold, ice formation could then be very thick and rapid. The most important suggestion by Oberts is to use a special riser for the outlet of the pond that can be used to draw down the water elevation during the winter. Ice would then form near the bottom of the pond and seal off the sediments. As the snowmelt occurs, the bottom outlets on the riser should be closed, forming a deeper pond for better sedimentation. Figure 16 shows a schematic of this pond.

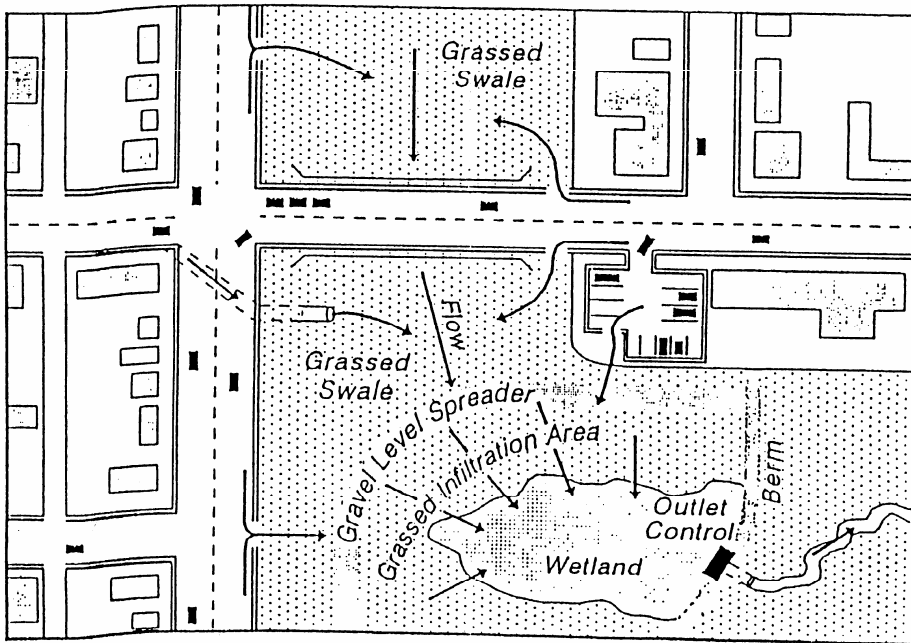
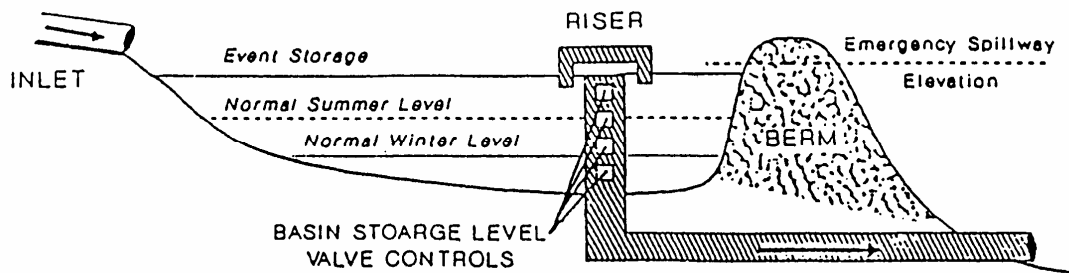

Figure 15. Treatment park concept for severe weather runoff and snowmelt treatment (Oberts 1994).





**Figure 16. Wet detention pond outfall risers for winter conditions (Oberts 1994).**

Droste and Johnston (1993) examined snowmelt quality from snow disposal areas in Ottawa and conducted treatability tests to examine the benefits of different settling times in 1 L test columns. They found that 2 to 6 hour settling times in these columns produced suspended solids and metal removals approaching 90%. These tests were conducted in controlled laboratory conditions and were not subjected to the actual site problems identified by Oberts. These tests do indicate that sedimentation treatment of snowmelt is likely beneficial, especially if the unique problems of scour and ice formation can be overcome.

Mayer, *et al.* (1996) examined the performance of four wet detention ponds in Toronto during different seasons and during non-storm conditions. The thick ice cover on the ponds during the winter severely affected the pond water quality. In addition, snowmelt and runoff from rainfall occurring on an existing snowpack, were poorly treated by the ponds. Few of the biochemical processes that normally enhance pollutant removal in wet detention ponds during warm weather are available during the winter, plus the ice pack decreases the efficiency of the physical processes, as noted by Oberts. Water beneath the winter ice was typically devoid of oxygen, causing the release of ammonia from sediments and increasing the water column concentrations to about 0.5 mg/L. High grit concentrations in snowmelt, associated with winter sanding of streets, were effectively removed in the detention ponds. However, the high chloride concentrations, from salting of the streets, were not affected by the ponds, as expected.

### **Detention Pond Design Fundamentals**

The basic design approaches for wet detention ponds consider either slug flow or completely mixed flow. Martin (1989) reviews these flow regimes and conducted five tracer studies in a wet detention pond/wetland in Orlando, FL, to determine the actual flow patterns under several storm conditions. Completely mixed flow conditions assumes that the influent is completely and instantaneously mixed with the contents of the pond. The concentrations are therefore uniform throughout the pond. Under plug flow conditions, the flow proceeds through the pond in an orderly manner, following streamlines and with equal velocity. The concentrations vary in the direction of flow and are uniform in cross section. The steady state resident time for both flow conditions is the same for both flow patterns, namely the pond volume divided by the discharge rate. Historically, wet detention ponds have been designed using the plug flow concept, probably because it had been used in conventional clarifier designs for water and wastewater treatment. In reality, detention ponds exhibit a combination flow pattern that Martin terms moderately mixed flow. He found that the type of mixing that actually occurs is dependent on the ratio of the storm volume to the pond storage volume. If the ratio is less than one, plug flow likely predominates. If the ratio is greater than one, the flow type is not as obvious. With faster flows in the pond, short-circuiting effectively reduces the available pond storage volume (and therefore the resident time), with less effective treatment.

The stormwater management system that Martin (1989) monitored was comprised of a 0.2 acre wet detention pond followed by a 0.7 acre wetland. The drainage area was 41.6 acres, with 33% roadway, 28% forest, 27% high density residential, and 13% low density residential land uses. The system was therefore about 2% of the drainage area, with the wet detention pond portion about 0.5% of the drainage area. The pond's maximum available live storage volume was 18,500 ft<sup>3</sup>. The system produces moderate to high pollutant reductions of solids, lead, and zinc (between 50 and 80%) and smaller reductions for nitrogen and phosphorus (between 30 and 40%). At low discharges and with large

storage volumes, the pond was found to be moderately well mixed with residence times not much less than the maximum expected if operating under ideal mixing conditions, with little short-circuiting apparent. At higher discharges and with less storage volume, significant short-circuiting occurred.

Detention facilities designed for flood control differ greatly from those designed for water quality improvements (Jones and Jones 1982 and Dally, *et al.* 1983). However, it is still possible to design dual purpose detention facilities to meet both water quality and flood control benefits. Flood control facilities are designed to affect large, but infrequent, storms and “ignore” smaller, but common, storms. Water quality facilities need to address the opposite set of conditions. Stormwater quality concerns are most commonly associated with frequent events that cause chronic long-term receiving water effects. As an example, very few fish kills have been related to specific storms, but many urban receiving waters have very poor fisheries due to continually poor quality urban runoff discharges (Pitt 1986).

Detention facilities can be designed to suppress the flows from small events and provide significant water quality benefits by using small primary outlets, such as stacked orifices or V-notch weirs. If adequate free-board storage is provided, significant flood control benefits from the same detention facilities are also possible. Alternately, wet detention ponds designed for water quality benefits can discharge to downstream dry detention facilities (through small primary outlets and emergency spillways) designed for flood control benefits alone.

Design considerations based on watershed scale is also important, especially for flood control purposes. Local flooding can be addressed by a relatively small detention facility that provides little, if any, downstream flood control benefit. From a water quality viewpoint, a detention facility can also be designed to protect a local sensitive water body that would produce very little downstream water quality benefits. These local objectives are legitimate, as long as downstream problems are not increased (as can occur with flood control facilities). Alternative local controls may also be available to alleviate both local problems and larger scale watershed problems.

### ***Upflow Velocity***

Linsley and Franzini (1964) stated that in order to get a fairly high percentage removal of particulates, it is necessary that a sedimentation pond be properly designed. In an ideal system, particles that do not settle below the bottom of the outlet will pass through the sedimentation pond, while particles that do settle below/before the outlet will be retained. The path of any particle is the vector sum of the water velocity ( $V$ ) passing through the pond and the particle settling velocity ( $v$ ). Therefore, if the water velocity is slow, slowly falling particles can be retained. If the water velocity is fast, then only the heaviest (fastest falling) particles are likely to be retained. The critical ratio of water velocity to particle settling velocity must therefore be equal to the ratio of the sedimentation pond length ( $L$ ) to depth to the bottom of the outlet ( $D$ ):

$$\frac{V}{v} = \frac{L}{D}$$

as shown on Figure 17.

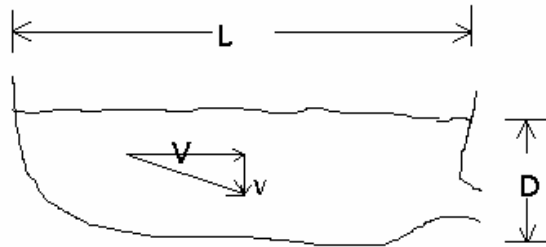

**Figure 17. Critical Velocity and Pond Dimensions**

The water velocity is equal to the water volume rate ( $Q$ , such as measured by cubic feet per second) divided by the pond cross-sectional area ( $a$ , or depth times width:  $DW$ ):

$$V = \frac{Q}{a}$$

or

$$V = \frac{Q}{DW}$$

The pond outflow rate equals the pond inflow rate under steady state conditions. The critical time period for steady state conditions is the time of travel from the inlet to the outlet. During critical portions of a storm, the inflow rate ( $Q_{in}$ ) will be greater than the outflow rate ( $Q_{out}$ ) due to freeboard storage. Therefore, the outflow rate controls the water velocity through the pond. By substituting this definition of water velocity into the critical ratio:

$$\frac{Q_{out}}{WDv} = \frac{L}{D}$$

The water depth to the outlet bottom ( $D$ ) cancels out, leaving:

$$\frac{Q_{out}}{Wv} = L$$

Or

$$\frac{Q_{out}}{v} = LW$$

However, pond length ( $L$ ) times pond width ( $W$ ) equals pond surface area ( $A$ ). Substituting leaves:

$$\frac{Q_{out}}{v} = A$$

and the definition of upflow velocity:

$$v = \frac{Q_{out}}{A}$$

where  $Q_{out}$  = pond outflow rate (cubic feet per second),  
 $A$  = pond surface area (square feet: pond length times pond width), and  
 $v$  = upflow velocity, or critical particle settling velocity (feet per second).

Therefore, for an ideal sedimentation pond, particles having settling velocities less than this upflow velocity will be removed. Only increasing the surface area, or decreasing the pond outflow rate, will increase pond settling efficiency. Increasing the pond depth does lessen the possibility of bottom scour, decreases the amount of attached aquatic plants, and decreases the chance of winter kill of fish. Deeper ponds may also be needed to provide sacrificial storage volumes for sediment between dredging operations.

The EPA (1986) detention pond water quality analysis procedure includes a partial credit for the removal of particles having settling velocities less than the critical upflow velocity. This is based on the assumption of full depth and well-mixed inlet zones that are used in conventional water treatment clarifiers, but are not likely for stormwater detention ponds which mostly have surface (or near surface) inlets. For stormwater detention ponds, it should be assumed that inlet zones are restricted to the pond surface and that the outlet zones are full depth, providing a worst-case situation.

For continuous flow conditions (such as for water or wastewater treatment), the following relationships can be shown:

$$t = \frac{Volume}{Flow\ rate}$$

and

$$Flow\ rate\ (Q_{out}) = \frac{Volume}{t}$$

where  $t$  = detention (residence) time. With

$$v = \frac{Q_{out}}{A}$$

and substituting:

$$v = \frac{Volume}{(t)(A)}$$

but

$$Volume = (A)(depth)$$

therefore,

$$v = \frac{(A)(depth)}{(t)(A)}$$

leaving:

$$v = \frac{depth}{t}$$

It is seen that the overflow rate ( $Q/A$ ) is equivalent to the ratio of depth to detention time. It is therefore not possible to predict pond performance by only specifying detention time. If pond depth was also specified (or kept within a typical and narrow range), then detention time could be used as a performance specification for a continuous or slug flow condition. However, it is not possible to hold all of the water in a detention pond for the specified detention time. Outlet devices typically release water at a high rate of flow when the pond stage is increased (resulting in minimal detention times during peak flow conditions) and lower flow rates at lower stages, after most of the detained water has already been released. The average detention time is therefore difficult to determine and is likely very short for most of the water during a moderate to large storm. It is much easier to design and predict pond performance using the upflow relationships for variable flow stormwater conditions.

The upflow ratio of outflow rate to pond surface area can be kept constant (or less than a critical value) for all pond stages. This results in a much more direct method in designing or evaluating pond performance. Pond performance curves can therefore be easily prepared relating upflow velocity (and therefore critical particle control) for all stages at a pond site.

### ***Effects of Short-Circuiting on Particulate Removals in Wet Detention Ponds***

Under dynamic conditions, particle trapping can be predicted using the basic Hazen theory presented by Fair and Geyer (1954) that considers short-circuiting effects:

$$\frac{y}{y_0} = 1 - \left[ 1 + \frac{v_0}{n(Q/A)} \right]^{-n}$$

where  $y_0$  = initial quantity of solids having settling velocity of  $v_0$   
 $y$  = quantity of these particles removed  
 $y/y_0$  = proportion of particles removed having this settling velocity  
 $Q$  = wet pond discharge  
 $A$  = wet pond surface area  
 $n$  = short-circuiting factor (number of hypothetical basins in series)

This equation is closely related to the basic upflow velocity equation developed previously and is also included in DEPTOND. The short-circuiting factor is typically given a value of 1 for very poor conditions, 3 for good conditions, and 8 for very good conditions. Short-circuiting allows some large particles to be discharged that theoretically would be completely trapped in the pond. However, field monitoring of particle size distributions of detention pond effluent shows that this has a very small detrimental effect on the suspended solids (and pollutant)

removal rate of a pond. Figure 18 shows the effects of different  $n$  values on the removal of particles having different settling rates ( $v$ ) compared to the critical settling rate ( $Q/A$ ). For a particle having a settling rate equal to the critical values ( $v = Q/A$ ), the ideal settling indicates 100% removal, while for “best performance” ( $n = \infty$ ), the actual removal would be only about 65%. If the pond had an  $n$  of 1 (very poor performance), the removal of this critical particle would be only 50%.

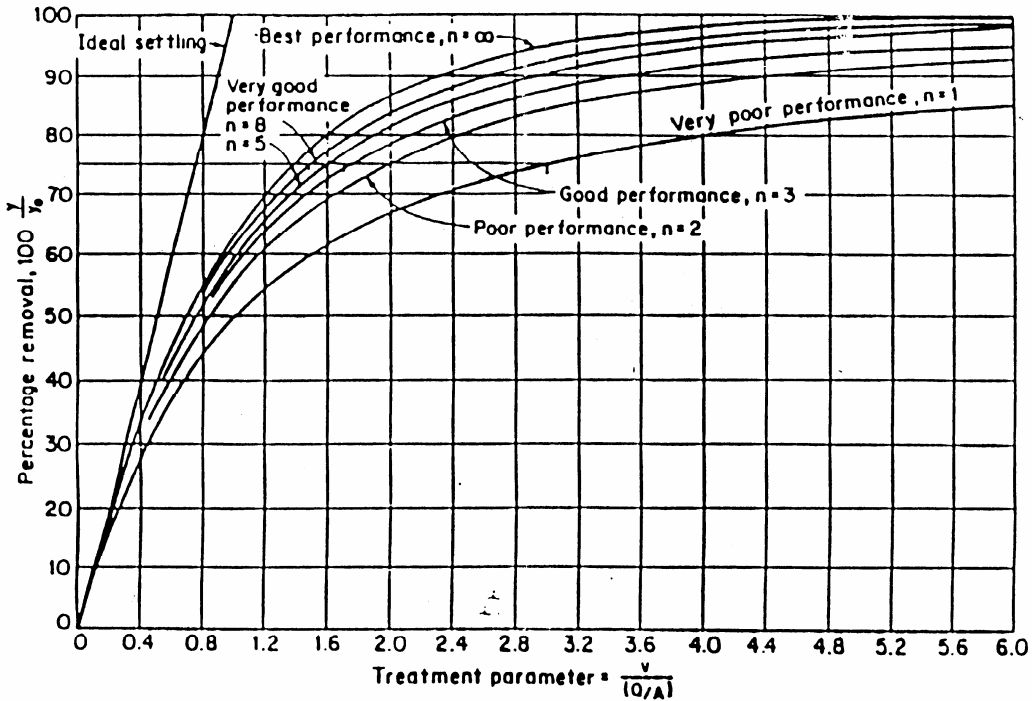

Figure 18. Performance curves for settling basins of varying effectiveness (AWWA 1971).

The degradation of performance is much worse for particles having settling rates much larger than the critical rate. However, most wet detention ponds are greatly over-sized according to their ability to remove large particles, so this degraded performance has minimal effect on the overall suspended solids removal. The suggested detention pond design presented in this discussion only operates at the “design” stage (where the critical particle size is being removed) a few times a year. At all other times, the smallest particles being removed in stormwater wet detention ponds are much smaller than the critical size used in the pond design. Most larger particles are effectively trapped because they are much larger than the design particle size (the pond is over-sized for these large particles), even if they are not being removed at their highest possible rate. In most cases, a few relatively large particles (much larger than the critical design particle size) will be observed in the pond effluent, but they have little effect on the overall SS removal.

Figure 19 shows example particle settling distributions for a pond, comparing effluent conditions using the short-circuiting effects of Hazen’s theory. The most common particle size (the mode) changes very little for the different effluent conditions. However, there are more larger-sized particles present in the effluent using Hazen’s theory compared to the ideal theory, and the median size obviously increases as the value for  $n$  decreases.

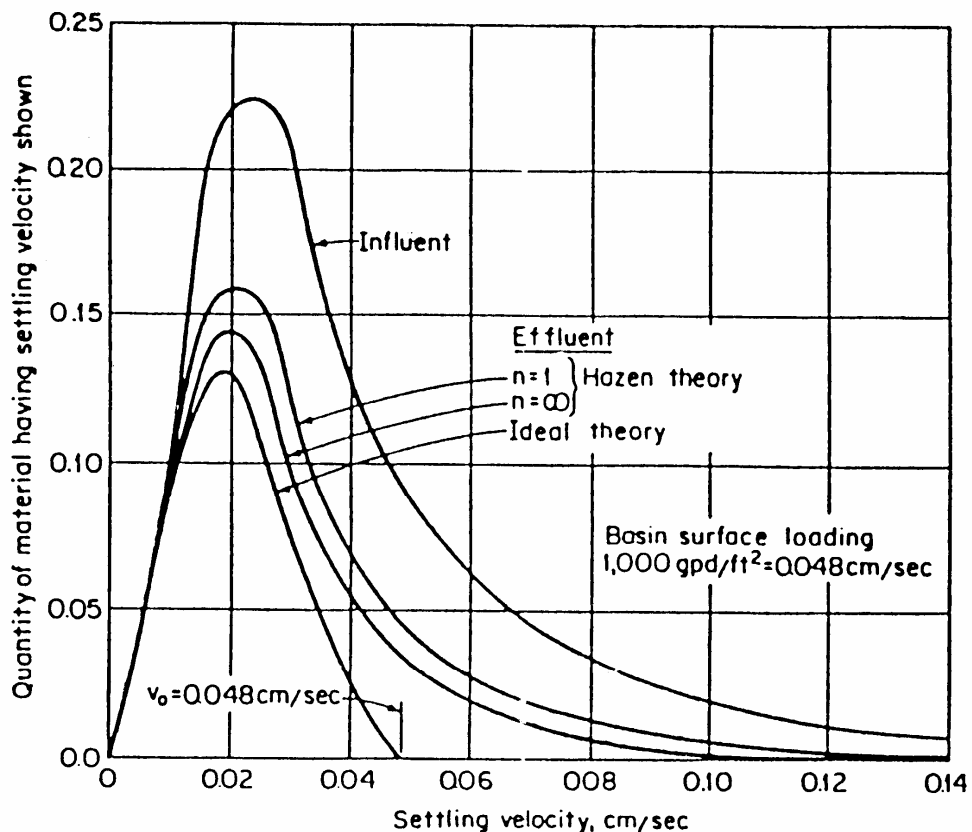

Figure 19. Influent and effluent particle settling rate distributions for settling basins of varying effectiveness (AWWA 1971).

Very little degraded performance was observed at a pond monitored during NURP (EPA 1983) in Lansing, MI, that was expected to have significant short-circuiting. A golf course pond located across the street from a commercial strip was converted into a stormwater pond, but the inlets and outlets were adjacent to each other in order to reduce construction costs. It was assumed that severe short circuiting would occur because of the close proximity of the inlet and outlet, but the pond produced suspended solids removals close to what was theoretically predicted, and similar to other ponds having much similar pond area to watershed area ratios. Actually, the close inlet and outlet may have resulted in less short-circuiting because the momentum of the inflowing waters may have forced the water to travel in a general circular pattern around the pond, instead of directly flowing across the pond (and “missing” some edge area) if the outlet was located at the opposite side of the pond.

In another example, the USGS and the Wisconsin Department of Natural Resources have been monitoring the Monroe St. wet detention pond in Madison for a number of years. Particle size distributions of influent (including bedload) and effluent have been monitored for about 50 storms. The actual particle size distributions and suspended solids removals have been compared to calculated pond performance, using the DETPOND computer program (Pitt and Voorhees 1989; Pitt 1993a and 1993b), for different short-circuiting factors. The calculated values of  $n$  (based on matching measured effluent particle size distributions with distributions calculated using different values of  $n$ ) ranged from about 0.2 to 1, indicating “very poor performance”, or worse. However, the pond is producing very good suspended solids removals (85 to 90% reductions) as designed, but the particle size distributions of the effluent indicate some short circuiting (some large particles are escaping from the pond). The short circuiting has not significantly reduced the effectiveness of the pond (measured as the percentage of suspended solids captured). Therefore, care should be taken in locating and shaping ponds to minimize short circuiting problems, but not at the

expense of other more important factors (especially size, or constructing the pond at all). Poor pond shapes probably cause greater problems by producing stagnant areas where severe aesthetic and nuisance problems originate.

### ***Residence Time and Extended Detention Ponds***

During quiescent conditions, simple column sedimentation occurs, with very little flow through a wet pond. Lateral flow would be caused by a baseflow from the watershed, supplemental water pumped from wells, or groundwater intrusion. Urban area baseflows of about 0.001 cfs per acre of contributing watershed have been observed (Pitt and McLean 1986), but can vary widely. The corresponding lateral flow for most ponds would be very small during dry weather. A 200 acre watershed may only have a baseflow of about 0.2 cfs and a two acre wet pond adequate to serve this watershed may be about 200 feet wide and three feet deep. The dry weather lateral flow would therefore be about  $3 \times 10^{-4}$  ft/sec. It would therefore require very large baseflows and very small ponds to result in significant lateral flows during dry periods. Therefore, interevent settling mainly occurs as a quiescent process, similar to what would be observed during typical settling column experiments (water depth divided by the residence time equaling the critical particle settling rate).

Residence time is defined as the ratio of volume to average flow rate, resulting in a time dimension. It can be assumed to be the average length of time any parcel of water remains in the pond. As in any pond performance measure or design criteria, residence time values are very dependent on good pond configurations. Harrington (1986) stresses the need to subtract pond “dead zones” from pond volume when calculating residence times. Dead zones (and associated short-circuiting) can significantly reduce pond effectiveness.

Designing a wet pond for the treatment of stormwater runoff based on residence time is usually not recommended. Barfield (1986) states that residence (detention) time is not a good criteria for pond performance, but the ratio of peak discharge rate to pond surface area (the peak upflow velocity) is a good criteria of performance. The state of Maryland uses a residence time standard as part of their design criteria for “extended detention” ponds. These ponds are normally dry between events, or have a small and shallow wet pond area near the outlet, and greatly extend in surface area during storms. For these types of ponds, Harrington (1986) found, through computer modeling studies, that a residence time of about nine days is needed to achieve a 70 percent reduction of particulate residue. Nine days is longer than the inter-event period for most rains in the midwest and the southeast, which is about three to five days. These types of ponds are therefore not expected to be very useful for locations where the interevent periods of rains is short, or the drain-down time of the pond is rapid.

Extended detention ponds may be a suitable retro-fitting alternative for existing dry detention ponds to achieve some water quality benefits. It may not be cost-effective, or it may be excessively disruptive to convert a dry detention pond into a standard wet detention pond. Most dry detention ponds are designed for flow rate reduction benefits and need large amounts of storage volume, or are used as athletic fields during dry weather. Complete re-grading of the site could be very expensive. The use of a relatively small wet pond near the outlet area could achieve some water quality benefits in addition to the existing water flow benefits, be a cost-effective retro-fit control measure, and still allow multiple use of the site. For new ponds, much more cost-effective solutions meeting water quality, flood control, and recreation benefits could be achieved with the use of a conventional wet pond located above a dry pond which has an infiltration trench along the dry pond invert.

Figure 20 can be used to estimate the residence time needed in an extended detention pond to achieve specific particle size reduction goals. For a six feet deep pond, a detention time of about three hours would allow particles greater than about ten  $\mu\text{m}$  to settle to the pond bottom. A detention period of 200 hours (about nine days) in this pond, would settle particles greater than about 1-1/2  $\mu\text{m}$ .



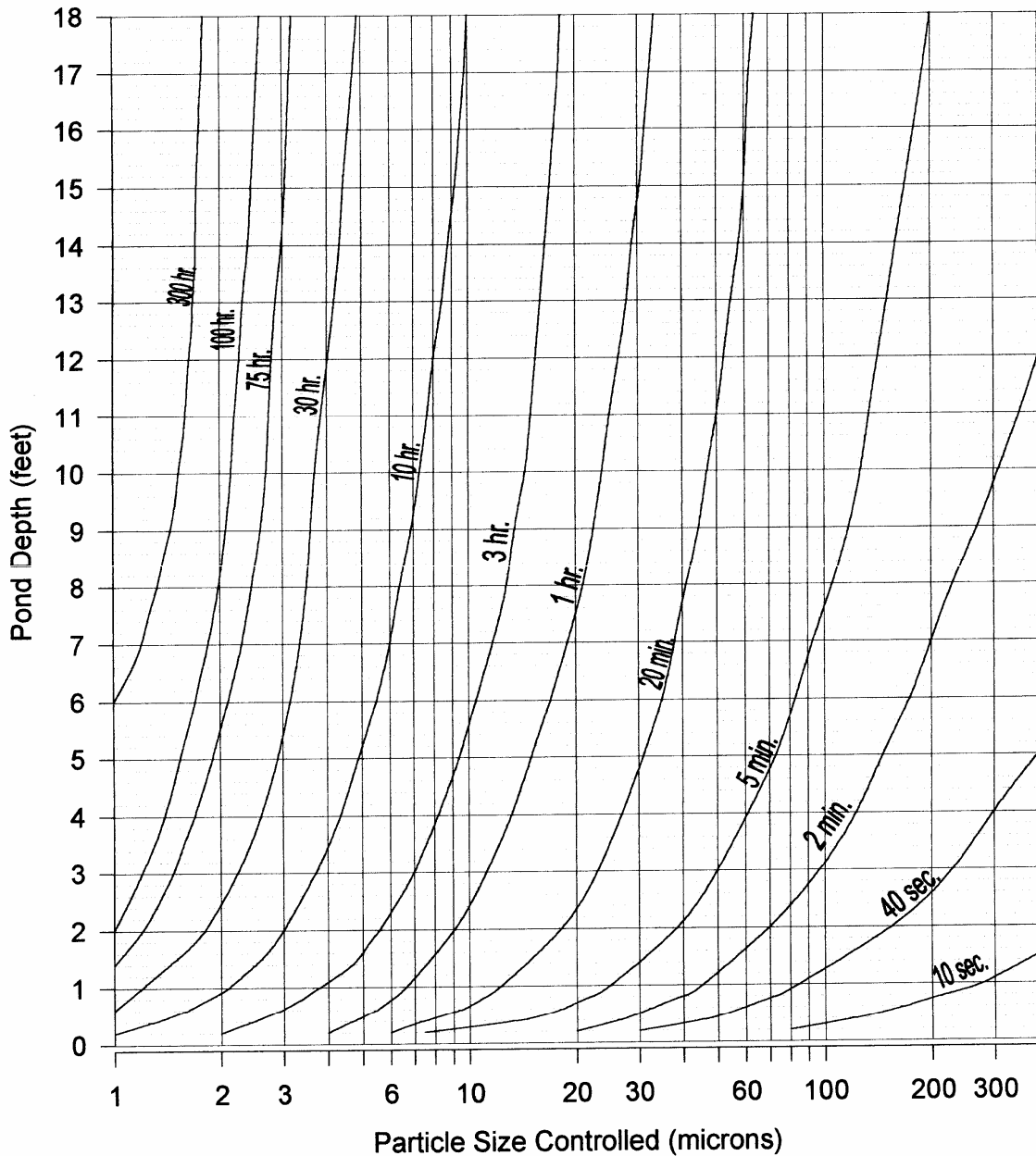

Figure 20. Required residence time for complete settling (hours).

Unfortunately, dry ponds usually do not allow permanent retention of the settled particles. Subsequent storms usually scour the fine particles previously settled to the pond bottom. As stated previously, dry detention ponds have not been shown to be consistently effective water quality control devices. The use of a small permanently wet detention pond or wetland at the downstream end of a dry detention pond could help recapture some of these scoured particles. As noted above, a wet detention pond above a dry pond is usually a much better solution, as the wet pond would then act as a pre-treatment pond, keeping particles and debris out of the dry pond. This would reduce dry pond maintenance and increase its safety by eliminating the deposition of toxic pollutants associated with polluted dust and dirt particles. This is very important if the dry pond is to be used for recreation.

One must be careful not to use Figure 20 to assume that shallow wet detention ponds are more effective than moderately deep ponds. In some cases, shallow forebays (about one foot deep) have been recommended for wet detention ponds, based on this residence time relationship. It appears that shallow detention ponds would require less residence time to control particles. The particles would strike the pond bottom sooner for a shallow pond, but increased turbulence (because of the shallow flow) would not allow the particles to remain in place, washing them into the main body of the pond, or out the pond outlet.

The discussion on pond depth summarizes many recommendations that wet ponds be at least three feet deep (and preferably five feet deep) over much of their area to reduce particle resuspension from flow turbulence. The discussion of pond configuration also recommends that a deep forebay be used at each pond inlet to provide extra sacrificial sediment storage volume and to concentrate the area of needed sediment removal. These design practices would significantly reduce pond maintenance dredging costs, as compared to dredging the entire pond.

The discussion on upflow velocity as a design criteria showed the relationship between particle settling rates and upflow velocity, while this discussion showed the relationship between particle settling rates and residence times. There must therefore be a relationship between residence time and upflow velocity. Residence time is dependent on pond volume and outlet rate, while upflow velocity is dependent on pond surface area and outflow rate. The relationship between residence time and upflow velocity is therefore equal to the relationship between pond volume and pond surface area, or the pond depth. When a pond depth of five feet is used, the residence times of ponds designed using the upflow velocity method are generally the same residence times needed for similar control levels using the residence time criteria. Even though the two procedures result in the same basic design, it is still recommended that the upflow procedure be used for wet detention ponds during storm events. The depth and configuration design criteria are very critical for the other pond uses (aquatic life, aesthetics, and safety, besides scour prevention) and they should not be varied as part of the major design elements.

The upflow velocity design procedure requires knowing the same stage-surface area and stage-discharge relationships that are also needed when designing ponds for flood control. These relationships also allow specific guidance in the selection of an outlet control device. The residence time design method should be used when designing extended detention ponds or for evaluating pond performance during dry intervals between rains when very little flow occurs.

### ***Particle Size***

Knowing the settling velocity characteristics associated with stormwater particulates is necessary when designing wet detention ponds. Particle size is directly related to settling velocity (using Stokes law, for example, and using appropriate shape factors, specific gravity and viscosity values) and is usually used in the design of detention facilities. Particle size can also be much more rapidly measured in the laboratory than settling velocities. Settling tests for stormwater particulates need to be conducted for about three days in order to quantify the smallest particles that are of interest in the design of wet detention ponds. If designing rapid treatment systems (such as grit chambers or vortex separators for CSO treatment), then much more rapid settling tests can be conducted. Probably the earliest description of conventional particle settling tests for stormwater samples was made by Whipple and Hunter (1981).

Whipple and Hunter (1981) contradict the assumption sometimes used in modeling detention pond performance that pollutants generally settle out in proportion to their concentrations. However, Grizzard and Randall (1986) have shown a relationship between particulate concentrations and particle size distributions. High particulate concentrations were found to be associated with particle size distributions that had relatively high quantities of larger particulates, in contrast to waters having low particulate concentrations. The high particulate concentration water would therefore have increased particulate removals in detention ponds. This relationship is expected to be applicable for pollutants found mostly in particulate forms (such as suspended solids and most heavy metals), but the relationship between concentration and settling would be much poorer for pollutants that are mostly in soluble forms (such as filterable residue, chlorides and most nutrients). Therefore, the partitioning of specific pollutants between the “particulate” and “dissolved” forms, and eventually for different particulate size fractions, is needed.

Smith (1982) also states that settleability characteristics of the pollutants, especially their particle size distribution, is needed before detention pond analyses can be made. Kamedulski and McCuen (1979) report that as the fraction of larger particles increase, the fraction of the pollutant load that settles also increases. Randall, *et al.* (1982), in settleability tests of urban runoff, found that non-filterable residue (suspended solids) behaves liked a mixture of discrete and flocculant particles. The discrete particles settled out rapidly, while the flocculant particles were very slow to settle out. Therefore, simple particle size information may not be sufficient when flocculant particles are also present. Particle size analyses should include identification of the particle by microscopic examination to predict the extent of potential flocculation.

Figure 21 shows approximate stormwater particle size distributions derived from several upper Midwest and Ontario analyses, from all of the NURP data (Driscoll 1986), and for several eastern sites that reflect various residue concentrations (Grizzard and Randall 1986). Pitt and McLean (1986) microscopically measured the particles in selected stormwater samples collected during the Humber River Pilot Watershed Study in Toronto. The upper Midwest data sources were two NURP projects: Terstriep, *et al.* (1982), in Champaign/Urbana Ill. and Akeley (1980) in Washtenaw County, Michigan.

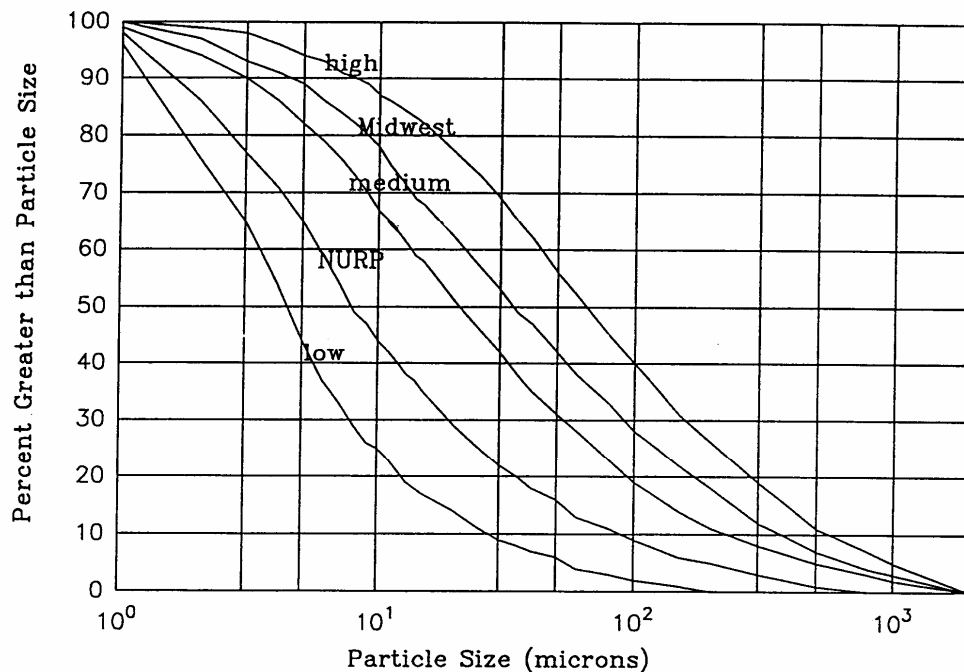

**Figure 21. Particle size distributions for various stormwater sample groups.**

Relatively few samples have been analyzed for stormwater particle sizes and no significant trends have been identified relating the particle size distribution to land use or storm condition. However, the work by Grizzard and Randall (1986) does indicate significantly different particle size distributions for stormwaters from the same site having different suspended solids concentrations. The highest suspended solids concentrations were associated with waters having relatively few small particles, while the low suspended solids concentration waters had few large particles. The particle size distribution for the upper Midwest urban runoff samples falls between the medium and high particulate concentration particle size distributions.

For many urban runoff conditions, the median stormwater particle size is estimated to be about 30  $\mu\text{m}$ , (which can be much smaller than the median particle size of some source area particulates). Very few particles larger than 1000  $\mu\text{m}$  are found in stormwater, but particles smaller than ten  $\mu\text{m}$  are expected to make up more than 20 percent of the

stormwater total residue weight. Similar observations of the predominance of very small particles have been made in other urban runoff detention pond studies (Ferrara 1982).

Specific conditions (such as source area type, rain conditions and upstream controls) have been shown to have dramatic effects on particle size distributions. Randall, *et al.* (1982) monitored particle size distributions in runoff from a shopping mall that was cleaned daily by street cleaning. Their data (only collected during the rising limb of the hydrographs) showed that about 80 percent of the particles were smaller than 25  $\mu\text{m}$ , in contrast to about 40 percent that were smaller than 25  $\mu\text{m}$  during the outfall studies. They also only found about two percent of the runoff particles in sizes greater than 65  $\mu\text{m}$ , while the outfall studies found about 35 percent of the particles in sizes greater than 65  $\mu\text{m}$ . This shopping mall runoff would therefore be less effectively treated by wet detention facilities because of the relatively smaller number of large particles present.

Limited data is also available concerning the particle size distribution of erosion runoff from construction sites. Hittman (1976) reported erosion runoff having about 70 percent of the particles (by weight) in the clay fraction (less than four  $\mu\text{m}$ ), while the exposed soil being eroded only had about 15 to 25 percent of the particles (by weight) in the clay fraction. When the available data is examined, it is apparent that many factors affect runoff particle sizes. Rain characteristics, soil type, and on-site erosion controls are all important.

Tests have also been conducted to examine the routing of particles through the Monroe St. detention pond in Madison, Wisconsin (Roger Bannerman, Wisconsin Department of Natural Resources, personal communication). This detention pond serves an area that is mostly comprised of medium residential, with some strip commercial areas. This joint project of the Wisconsin Department of Natural Resources and the U.S. Geological Survey has obtained a number of inlet and outlet particle size distributions for a wide variety of storms. The observed median particle sizes ranged from about 2 to 26  $\mu\text{m}$ , with an average of 9  $\mu\text{m}$ . The following list shows the average particle sizes corresponding to various distribution percentages for the Monroe St. outfall:

Percent larger than size	Particle Size ( $\mu\text{m}$ )
10 %	450
25	97
50	9.1
75	2.3
90	0.8

These distributions included bedload material that was also sampled and analyzed during these tests. This distribution is generally comparable to the "all NURP" particle size distribution presented previously. The critical particle sizes corresponding to the 50 and 90 percent control values are as follows for the different data groups:

	90 %	50%
Monroe St.	0.8	9.1 $\mu\text{m}$
All NURP	1	8
Midwest	3.2	34
Low solids conc.	1.4	4.4
Medium solids conc.	3.1	21
High solids conc.	8	66

The particle size distributions of stormwater at different locations in an urban area greatly affect the ability of different source area and inlet controls in reducing the discharge of stormwater pollutants. A series of recent U.S. Environmental Protection Agency (USEPA) funded research projects has examined the sources and treatability of

urban stormwater pollutants (Pitt, *et al.* 1995). This research has included particle size analyses of 121 stormwater inlet samples from three states (southern New Jersey; Birmingham, Alabama; and at several cities in Wisconsin) in the U.S. that were not affected by stormwater controls. Particle sizes were measured using a Coulter Counter Multi-Sizer IIe and verified with microscopic, sieve, and settling column tests. Figures 22 through 24 are grouped box and whisker plots showing the particle sizes (in  $\mu\text{m}$ ) corresponding to the 10<sup>th</sup>, 50<sup>th</sup> (median) and 90<sup>th</sup> percentiles of the cumulative distributions. If 90 percent control of suspended solids (by mass) was desired, then the particles larger than the 90<sup>th</sup> percentile would have to be removed, for example. In all cases, the New Jersey samples had the smallest particle sizes (even though they were collected using manual “dipper” samplers and not automatic samplers that may miss the largest particles), followed by Wisconsin, and then Birmingham, Alabama, which had the largest particles (which were collected using automatic samplers and had the largest rain intensities). The New Jersey samples were obtained from gutter flows in a residential neighborhood that was xeroscaped, the Wisconsin samples were obtained from several source areas, including parking areas and gutter flows mostly from residential, but from some commercial areas, and the Birmingham samples were collected from a long-term parking area on the UAB campus.

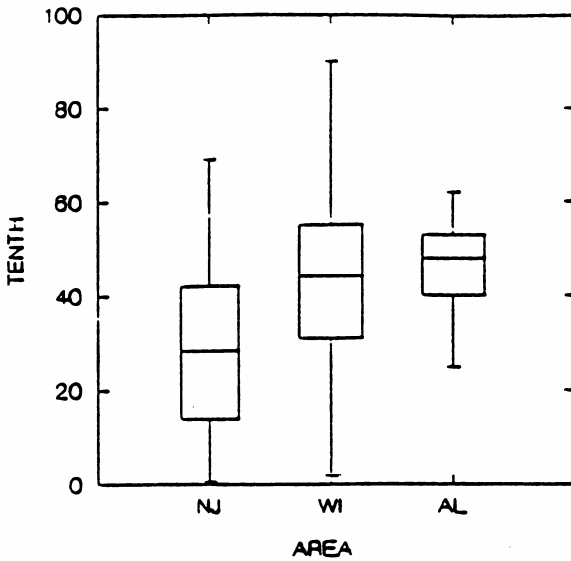

Figure 22. Tenth percentile particle sizes for stormwater inlet flows (Pitt, *et al.* 1997).

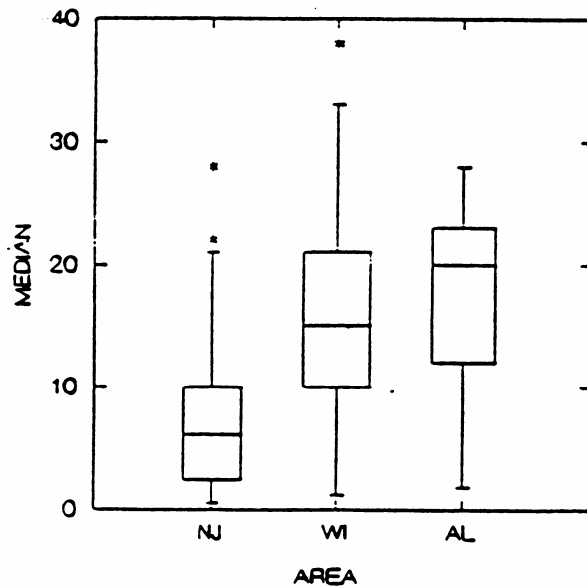

Figure 23. Fiftieth percentile particle sizes for stormwater inlet flows (Pitt, *et al.* 1997).

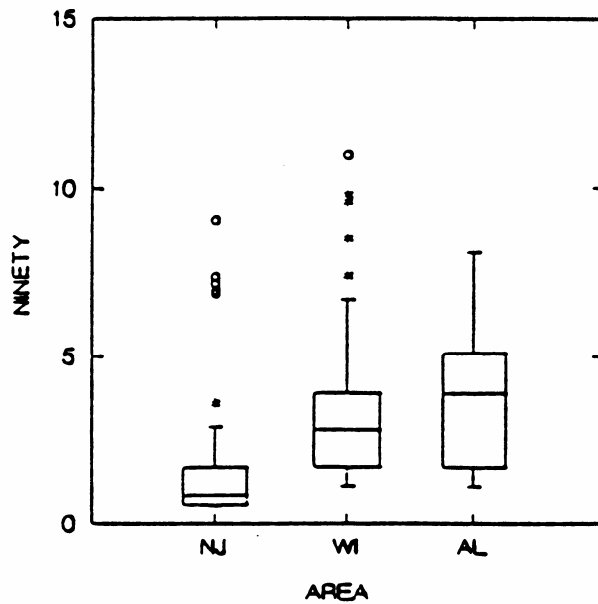

Figure 24. Ninetieth percentile particle sizes for stormwater inlet flows (Pitt, *et al.* 1997).

The median particle sizes ranged from 0.6 to 38 $\mu$ m and averaged 14 $\mu$ m. The 90<sup>th</sup> percentile sizes ranged from 0.5 to 11 $\mu$ m and averaged 3 $\mu$ m. These particle sizes are all substantially smaller than have been typically assumed for stormwater. Stormwater particle size distributions typically do not include bed load components because automatic sampler intakes are usually located above the bottom of the pipe where the bed load occurs. During the Monroe St. (Madison, WI) detention pond monitoring, the USGS and WI DNR installed special bed load samplers that trapped the bed load material for analysis. This additional bed load comprised about 10 percent of the annual total solids loading. This is not a large fraction of the solids, but it represents the largest particle sizes flowing in the stormwater

and it can be easily trapped in most detention ponds or catchbasins. The bed load component in Madison was most significant during the early spring rains when much of the traction control sand that could be removed by rains was being washed from the streets.

Additional data obtained by Pitt, *et al.* (1997) for the USEPA described particle sizes from many different source flows in the Birmingham, Alabama, area. These data did not indicate any significant differences in particle size distributions for different source areas or land uses, except that the roof runoff had substantially smaller particle sizes than the other areas sampled.

### Particle Settling Velocities

The settling velocities of discrete particles are shown in Figure 25, based on Stoke's and Newton's settling relationships. Probably more than 90% of all stormwater particulates are in the 1 to 100  $\mu\text{m}$  range, corresponding to laminar flow conditions, and appropriate for using Stoke's law. This figure also illustrates the effects of different specific gravities on the settling rates. In most cases, stormwater particulates have specific gravities in the range of 1.5 to 2.5. This corresponds to a relatively narrow range of settling rates for a specific particle size. Particle size is much easier to measure than settling rates and it is generally recommended to measure particle sizes using automated particle sizing equipment (such as a Coulter Counter Multi-Sizer IIe) and to conduct periodic settling column tests to determine the corresponding specific gravities. If the particle counting equipment is not available, then small scale settling column tests (using 50 cm diameter Teflon™ columns about 0.7 m long) can be easily used.

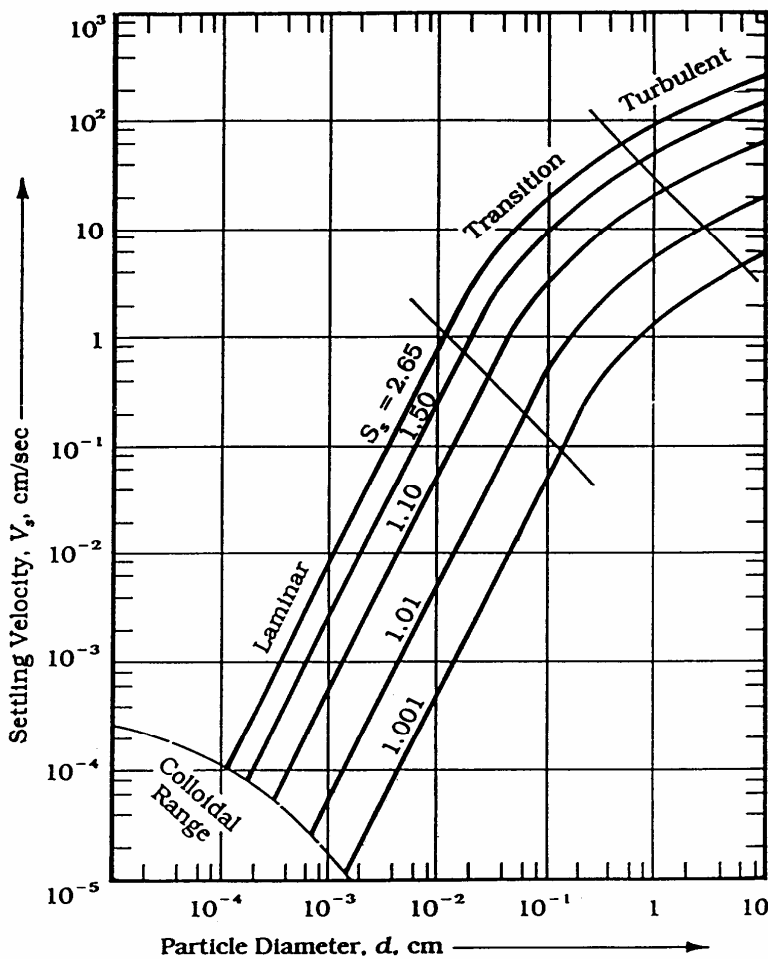

**Figure 25. Type 1 (discrete) settling of spheres in water at 10° C (Reynolds 1982).**

These settling velocities (or particle sizes) are used with the pond outflow rate to determine the required pond surface area. Figure 26 shows the minimum pond surface area needed to capture particles of a specific size (and larger) for different pond outflow rates.

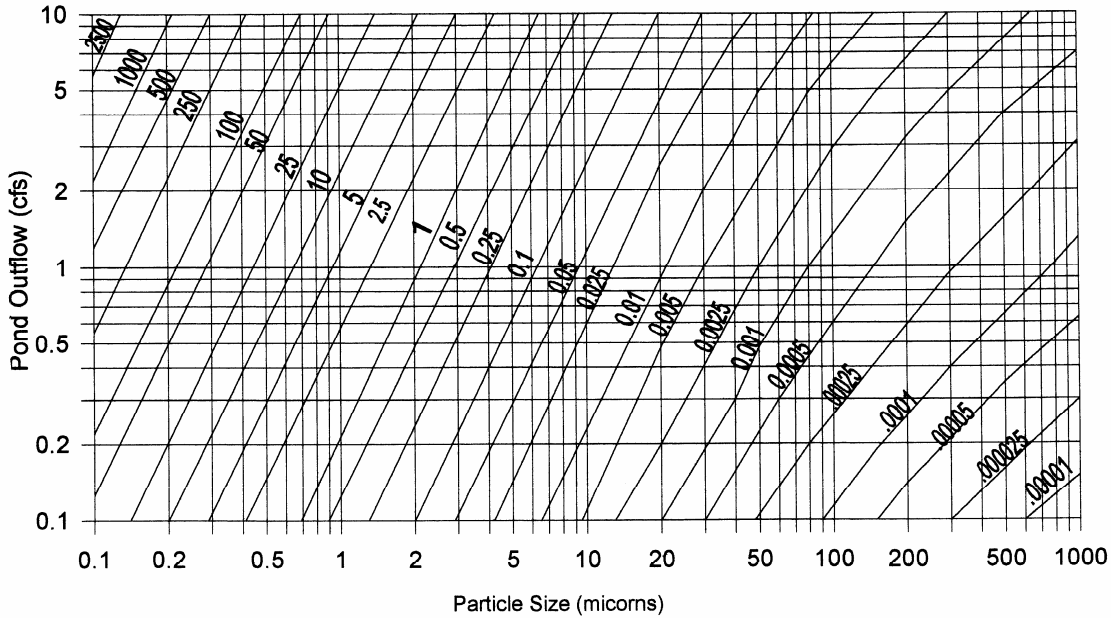

**Figure 26. Minimum pond size (acres) needed for complete settling of specific sized particles at various pond overflow rates.**

Particle settling observations in actual detention ponds have generally confirmed the ability of well designed and operated detention ponds to capture the “design” particles. Gietz (1983) found that particles smaller than 20  $\mu\text{m}$  were predominate (comprised between 50 to 70 percent of the sediment) at the outlet end of a “long” monitored pond, while they only made up about ten to 15 percent of the sediment at the inlet end. Particles between 20 and 40  $\mu\text{m}$  were generally uniformly distributed throughout the pond length, and particles greater than 40  $\mu\text{m}$  were only found in the upper (inlet) areas of the pond. The smaller particles were also found to be resuspended during certain events.

Pisano and Brombach (1996) recently summarized numerous solids settling curves for stormwater and CSO samples. They are concerned that many of the samples analyzed for particle size are not representative of the true particle size distribution in the sample. As an example, it is well known that automatic samplers do not sample the largest particles that are found in the bedload portion of the flows. Particles having settling velocities in the 1 to 15 cm/sec range are found in grit chambers and catchbasins, but are not seen in stormwater samples obtained by automatic samplers, for example. It is recommended that bedload samplers be used to supplement automatic water samplers in order to obtain more accurate particle size distributions (Burton and Pitt 2000). Selected US and Canadian settling velocity data are shown in Table 7. The CSO particulates have much greater settling velocities than the other samples, while the stormwater has the smallest settling velocities. The corresponding “Stoke’s” particle sizes for the geometric means are about 100  $\mu\text{m}$  for the CSOs, about 50  $\mu\text{m}$  for the sanitary sewage, and about 15  $\mu\text{m}$  for the stormwater.



**Table 7. Settling Velocities for Wastewater, Stormwater, and CSO**

Samples	Geometric Means of Settling Velocities Observed (cm/sec)	Range of Medians of Settling Velocities Observed (cm/sec)
CSO	0.22	0.01 to 5.5
dry weather wastewater (sanitary sewage)	0.045	0.030 to 0.066
stormwater	0.011	0.0015 to 0.15

Source: Pisano and Bromback (1996)

More than 13,000 CSO control tanks have been built in Germany using the ATV 128 rule (Pisano and Bromback 1996). This rule states that clarifier tanks (about 1/3 of these CSO tanks) are to retain all particles having settling velocities greater than 10 m/hr (0.7 cm/sec), with a goal of capturing 80% of the settleable solids. Their recent measurements of overflows from some of these tanks indicate that the 80% capture was average for these tanks and that the ATV 128 rule appears to be reasonable.

### ***Pond Water Losses and Liners***

Evaporation and infiltration losses can have very important aesthetic, recreation, and wildlife effects. In some cases, the pond may totally dry-up if little supplemental inflows (baseflows from the drainage area, groundwater infiltration to the pond, or supplemental groundwater pumping to the pond) occur for ponds over highly permeable soils, and/or if long dry periods occur between rains. Maryland does not allow wet detention ponds to be located in areas of highly permeable NRCS hydrologic class A soils (those having saturated soil infiltration rates greater than 0.5 inches per hour) (Harrington 1986). Harrington also reports that Maryland requires pond sealing if underlying soils have infiltration rates between 0.1 and 0.5 inches per hour (generally includes all class C and class B soils, and even some class D soils). NRCS hydrologic soil types in urban areas or for small areas should not be determined using the soil maps for undisturbed areas alone. Typical soil disturbance in urban areas can greatly affect the infiltration and percolation characteristics of native soils. In addition, it is common for excavation and fill processes to expose a completely different soil at a site.

As part of the Wisconsin Priority Watershed Program (Pitt 1986), a series of infiltration tests were conducted in the city of Oconomowoc, Wisconsin. These tests were conducted to calibrate the Source Loading and Management Model (SLAMM) (Pitt 1988) being used by the Wisconsin Department of Natural Resources. Oconomowoc is characterized as having mostly sandy soils (NRCS hydrologic soil types A and B predominated before development). Observed infiltration rates varied greatly, ranging from 0 to 25 inches per hour. The only relationship found between the type of area tested and the infiltration rates was the amount of site disturbance (compacted). Even though the soils were mostly sandy, high foot traffic areas (such as at schools and in many front lawns) had very low infiltration rates. Many swale linings also had very low infiltration rates (many had 0 inches per hour), probably because of construction techniques that used clayey soils as ditch linings or were clogged with fines from construction erosion. These areas could not be considered as “pervious”. It would be very misleading to assume that they had similar infiltration rates as native A or B soils. In addition, many of the final infiltration rates observed were substantially greater than the initial infiltration rates, in contrast to typical infiltration rate theory. The median infiltration rate for these “sandy” soils was about 5 inches per hour, corresponding to rates for type A soils, but many sandy soil areas tested had rates that were much less than this value (corresponding to class D soils).

It is therefore imperative that percolation and infiltration tests, along with soil surveys, be conducted at all potential pond locations before final design. If the pond will be excavated, a percolation test should be used, while double ring infiltration tests should be conducted for areas that will use the natural surface for the pond lining.

Figure 27 illustrates how much the pond surface elevation could decrease for various pond loss rates and dry periods. The total pond loss rates include both infiltration losses through underlying soils plus evaporation. Table 8 presents approximate infiltration rates for different soil texture classes and NRCS hydrologic soil groups (from Harrington 1986 and SCS 1986). If pan evaporation losses average about 30 inches per year (not unusual), it may possibly reach as high as 0.03 inches per hour during the hottest summer afternoons. Only clay soils probably have infiltration losses less than this evaporation loss rate.

**Table 8. Approximate Saturated Infiltration Rates for Different Soil Texture Classes**

Soil Texture Class	SCS Hydrologic Soil Group	Saturated Soil Infiltration Rates	
		(in/hr)	(min/in)
Sand	A	8	7.5
Loamy Sand	A	2.5	24
Sandy Loam	A	1	60
Loam	B	0.5	120
Silt Loam	B	0.3	200
Sandy Clay Loam	C	0.2	300
Clay Loam	D	0.1	600
Silty Clay Loam	D	0.05	1200
Sandy Clay	D	0.05	1200
Silty Clay	D	0.04	1500
Clay	D	0.02	3000

Source: Harrington 1986 and SCS 1986

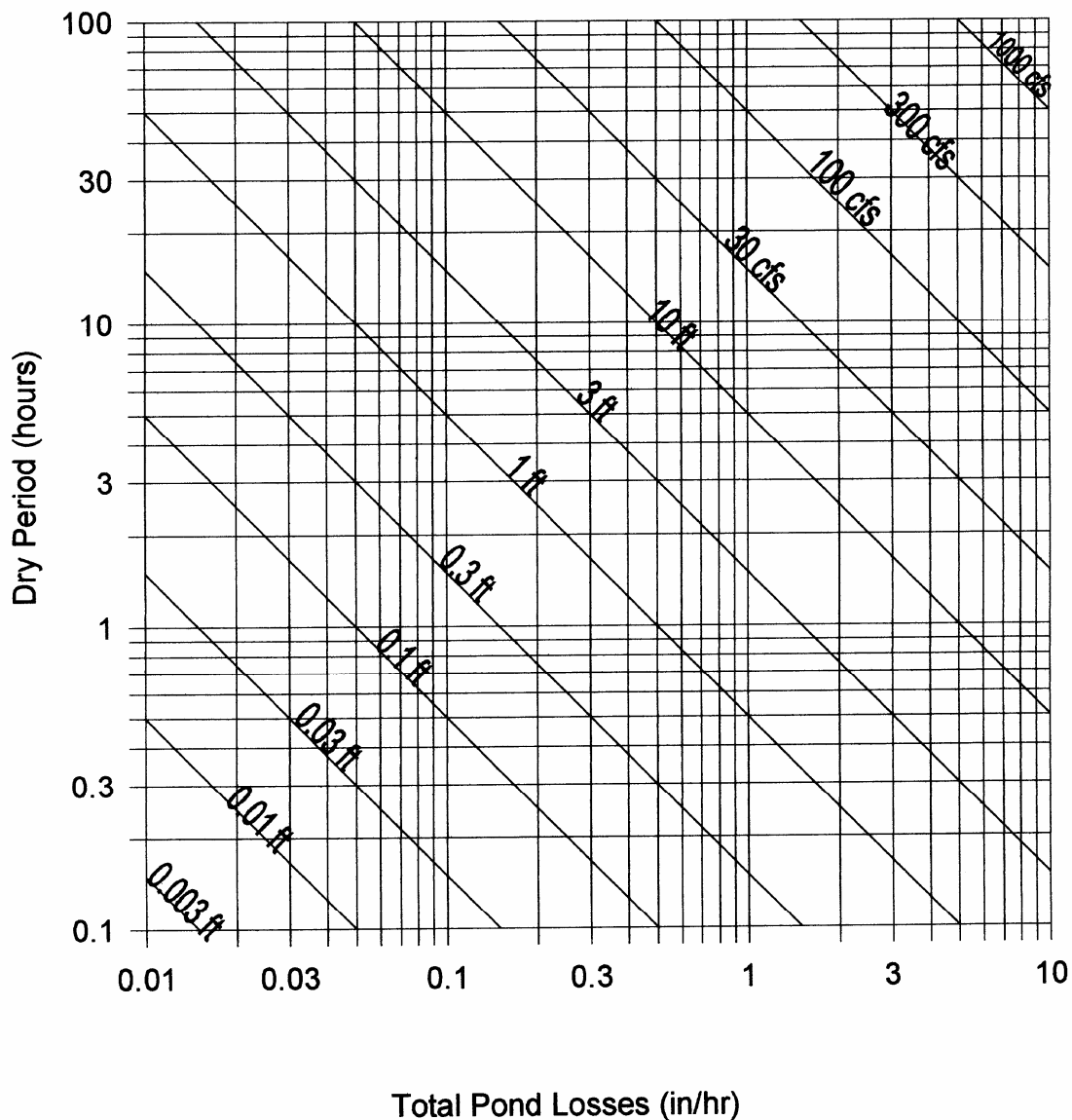

Figure 27. Pond water surface elevation drop (ft.) if no pond inflow during dry periods.

Figure 27 shows that unlined ponds in class A soils could lose about one foot of water elevation to infiltration during a two to eight hour runoff event and about ten feet of water surface elevation between the three to five days between events. Clearly, a wet pond over class A soils, without a liner and/or supplemental inflow, would not remain wet for long.

Figure 28 shows that a two acre pond over class A soils (having a three inch per hour infiltration rate) would need an inflow of about five cfs in order to maintain a constant water surface elevation. A two acre pond may adequately serve a residential area of about 250 acres, or a shopping center of about 75 acres. This inflow requirement could therefore vary from about 0.02 to 0.07 cfs per acre of watershed. Dry weather urban runoff baseflows may be less than five percent of the inflow requirement (Pitt and McLean 1986). Therefore, in order to maintain a constant water surface elevation for typical watershed and pond sizes, maximum infiltration rates from a residential area would need to be less than about 0.15 inches per hour (a class C soil), while a shopping center would require a maximum

soil infiltration rate of about 0.04 inches per hour (a class D soil). In most cases, pond percolation losses will decrease with time as sediments accumulate.

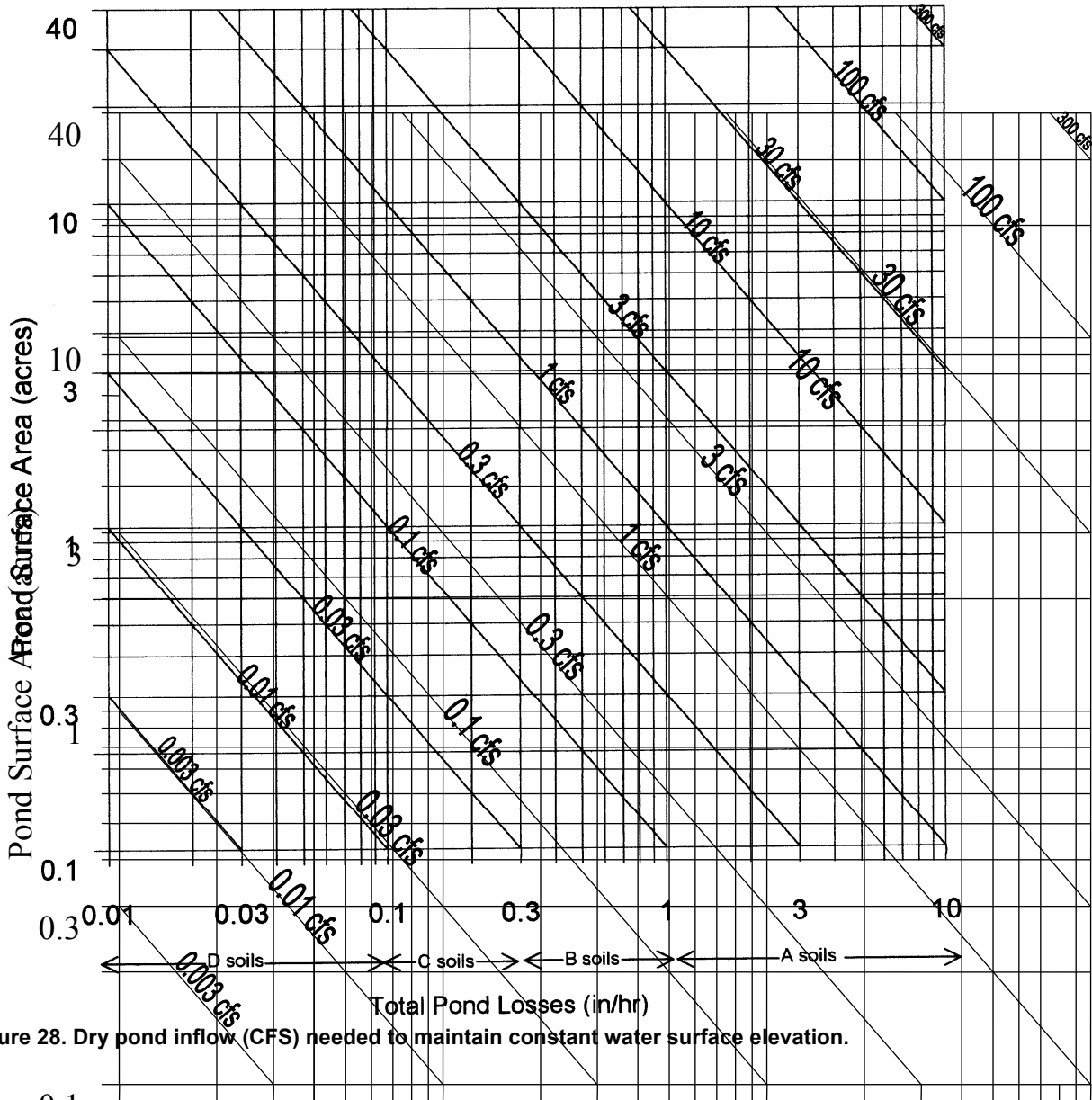

Figure 28. Dry pond inflow (CFS) needed to maintain constant water surface elevation.

Harrington (1986) has summarized different wet pond linings used in Maryland:

“Compacted D soils C soils B soils A soils”  
 Some pond areas can be made relatively impervious by compaction alone if the underlying soil material contains sand, silt, and at least ten percent clay. However, the reduction of seepage losses may be difficult to determine without taking an infiltration test of the soil. This method is the least expensive method to reduce the soil permeability.

Figure 28. Dry pond inflow (cfs) needed to maintain constant water surface elevation.

### **Clay Blankets**

Pond areas containing high percentages of coarse grained soils can be sealed by blanketing them with clay layers. The best clay blanket would consist of a material containing 40 percent or more of clay, but no less than 20 percent. The thickness of the blanket is a function of the depth of water to be impounded. Use a minimum thickness of 12 inches for all depths of water up to ten feet. Increase this thickness by two inches for each foot of water over ten feet.

### **Waterproof Linings**

Waterproof linings are another way of reducing excessive seepage. Polyethylene, vinyl, butyl-rubber membranes, and asphalt-sealed fabric liners are being used because they virtually eliminate seepage if properly installed.

Thin films of these materials are structurally weak, but if not broken or punctured, they are almost completely watertight. Black polyethylene films are less expensive and have better aging properties than vinyl. Vinyl, on the other hand, is more resistant to impact damage and is readily seamed and patched with a solvent cement.

All plastic membranes should have a cover of earth and gravel not less than six inches thick to protect against punctures. The bottom three inches of cover should be no coarser than silty sand.”

### ***Flow Rate Reductions In Water Quality Ponds***

Most flood control ponds are dry ponds so the maximum storage volume is available to attenuate excess inflows. As stated previously, dry ponds do not effectively retain sediment because of bottom scour of the deposited sediments. A wet pond only slightly reduces peak flows during large storms if substantial amounts of extra storage are not provided above the permanent pond water surface elevation. Inflowing peak flows would be slightly moderated because of back-water profile and surface wave effects providing some temporary additional storage volumes. Peak flow rates from small storms can be substantially reduced with the freeboard storage normally provided in wet detention ponds, however. If additional land area and pond depth is available, then wet ponds can be designed to provide both significant flood control and water quality improvements. NRCS (SCS 1986) methods can be used to estimate the additional storage volume above the permanent wet pond water surface to provide desired flood control benefits. The use of multiple outlet devices can be effectively used to help provide these dual benefits.

McCuen (1980) has defined a peak flow reduction factor to describe the ability of a detention pond to reduce flow rates. This factor is:

$$PRF = 1 - Q_o / Q_i$$

where  $Q_o$  is the outflow rate from the pond, and  $Q_i$  is the inflow rate to the pond. A 90% reduction in peak flow (say from 10 cfs inflow to 1 cfs outflow) would therefore have a PRF of 0.9. This value approaches 1.0 for very large flow reductions and 0.0 for very small flow changes.

### ***Control of Pollutants Other Than Suspended Solids***

Randall, *et al.* (1982), recognized the strong correlation between pollutant removal effectiveness in wet detention ponds and pollutant associations with suspended solids. High lead removals were related to lead's affinity for suspended solids, while much smaller removals of BOD<sub>5</sub> and phosphorus were usually obtained because of their significant soluble fractions.

Wet detention ponds also are biological and chemical reactors. Changes in many pollutants can take place in the water column or in the sediments of ponds. Dally, *et al.* (1983) monitored heavy metal forms in runoff entering and leaving a wet detention pond serving a bus maintenance area. They found that metals entering the monitored pond were generally in particulate (nonfilterable) forms and underwent transformations into filterable (smaller than 0.2  $\mu$ m in size) forms. The observed total metal removals by the pond were generally favorable, but the filterable metal outflows were much greater than the filterable metal inflows. This effect was most pronounced for cadmium and lead. Very little changes in zinc were found, probably because most of the zinc entering the pond was already in filterable forms. These metal transformations may be more pronounced in wet detention ponds than in natural waters

because of potentially more favorable (for metal dissolution) pH and ORP conditions in wet pond sediments. Other studies have found similar transformations in the forms and availability of nutrients in wet detention ponds, usually depending on the extent of algal growth and algal removal operations.

The previously presented information can be used to estimate the design configuration of detention ponds based on many site conditions and objectives, for suspended solids. Table 9 can be used to estimate the approximate controls for other pollutants. These ratios of pollutant removals to suspended solids removals are based on many field observations (mostly from the NURP studies, EPA 1983) of detention pond performance and can vary significantly. Three general groupings were identified: total lead and total copper were most efficiently removed, while organic nitrogen was the least efficiently removed. Many of the nutrients showed “negative” removals during monitoring, possibly because of biological cycling of the nutrients in the ponds. Wet detention ponds should not be expected to provide significant removals of any pollutants in “soluble” forms (associated with very small particles, colloids, or truly dissolved).

**Table 9. Approximate Control of Stormwater Pollutants in Wet Detention Ponds**

Constituent Group	Percentage Control as a Fraction of Suspended Solids Control
Lead and copper	0.75 to 1.00+
COD, BOD <sub>5</sub> , soluble and total phosphorus, nitrates, and zinc	0.6
Organic nitrogen	0.4

Example: If 85% control of suspended solids, then:  
 Lead and copper: 0.75 to 1.0+ of 85% = 64 to 85+%  
 COD, etc.: 0.6 of 85% = 51%  
 Organic nitrogen: 0.4 of 85% = 34%

The relationship between solids retention and pollution retention is important for wet detention ponds. Becker, *et al.* (1995) used settling column tests to measure the settling characteristics of different pollutants in sanitary sewage. They found that the majority of the particulate fractions of COD, copper, TKN, and total phosphorus was associated with particles having settling velocities of 0.04 to 0.9 cm/sec. Figure 29 is an example plot showing the relationship of particulate COD and different settling velocity fractions.

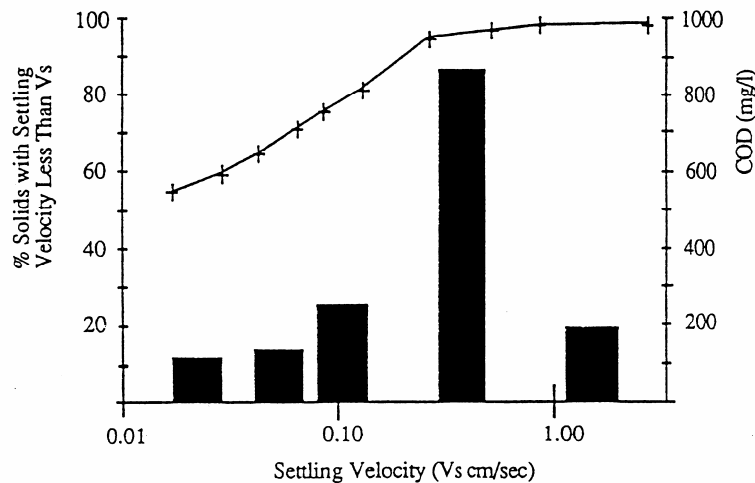

**Figure 29. COD and particulate settling velocity (Butler, *et al.* 1993).**

Vignoles and Herremans (1995) also examined the heavy metal associations with different particles sizes in stormwater samples from Toulouse, France. They found that the vast majority of the heavy metal loadings in

stormwater were associated with particles less than 10 µm in size, as shown on Table 10. They concluded that stormwater control practices must be able to capture the very small particles.

**Table 10. Percentages of Suspended Solids and Distribution of Heavy Metal Loadings Associated with Various Stormwater Particulate Sizes (Toulouse, France) (Percentage associated with size class, concentration in mg/kg).**

	>100 µm	50 to 100 µm	40 to 50 µm	32 to 40 µm	20 to 32 µm	10 to 20 µm	<10 µm
Suspended solids	15%	11%	6%	9%	10%	14%	35%
Cadmium	18 (13)	11 (11)	6 (11)	5 (6)	5 (5)	9 (6)	46 (14)
Cobalt	9 (18)	5 (16)	4 (25)	6 (20)	6 (18)	10 (22)	60 (53)
Chromium	5 (21)	4 (25)	2 (26)	6 (50)	3 (23)	9 (39)	71 (134)
Copper	7 (42)	8 (62)	3 (57)	4 (46)	4 (42)	11 (81)	63 (171)
Manganese	8 (86)	4 (59)	3 (70)	3 (53)	4 (54)	7 (85)	71 (320)
Nickel	8 (31)	5 (27)	4 (31)	5 (31)	5 (27)	10 (39)	63 (99)
Lead	4 (104)	4 (129)	2 (181)	4 (163)	5 (158)	8 (247)	73 (822)
Zinc	5 (272)	6 (419)	3 (469)	5 (398)	5 (331)	16 (801)	60 (1,232)

Source: Vignoles and Herremans (1995)

### ***Natural Bacterial Dieoff in Detention Ponds***

Chick's law can be used to predict the dieoff of bacteria (Chick 1908). It is usually expressed as:

$$\text{percent of bacteria remaining} = e^{-K_e t}, \text{ therefore}$$

$$\text{the fraction of bacteria removed (in time } t) = 1 - e^{-K_e t}$$

where  $K_e$  is the dieoff rate (units per day) and  $t$  is the time (days).  $K_e$  is 2.3 times larger than the commonly reported  $K_{10}$  values. Since detention ponds can hold runoff water for a substantial period of time, significant bacteria reductions may be possible because of natural dieoff. However, during most storms, most of the water passes through the pond with little delay, and only relatively small portions of the annual discharges are actually held in the pond during extended interevent periods.

The average detention time of a lake is determined by dividing the lake volume by the average flow rate. In a stormwater detention pond, the flow rate is highly variable, being very high for short periods of time and very low for relatively long interevent periods. It is not uncommon for most rains to only last for several hours, while the interevent durations may last for several days. Therefore, the detention time is difficult to analyze. The overall reductions in bacteria populations would therefore be dependent on the relative quantities of runoff that pass through a pond during an event (with a relatively short detention time) and the amount that would be stored before the next event (with a relatively long detention time). DETPOND calculates and tracks the pond "flushing ratio," the storm volume compared to the amount of water in the pond at the beginning of the event, and is useful for these determinations.

The Long Island NURP project (Lawler, Matusky and Skelly Engineers, *et al.* 1982) investigated the dieoff of bacteria in detention ponds. They summarized *in situ* coliform bacteria dieoff rates from other locations and measured dieoff rates for their local conditions. They summarized  $K_{10}$  rates ranging from 0.18 to 11.4 per day (corresponding to  $K_e$  rates of 0.41 to 26.2 per day). They concluded that coliform bacteria dieoff rates ( $K_e$ ) of about 2.3 per day are reasonable for stormwater.

Figure 30 indicates the percentage dieoff of bacteria, based on differing  $K_e$  rate constants and detention times. This figure indicates that coliform dieoff should be quite complete after about two days of detention (assuming a typical  $K_e$  value of 2.3/day). However, most urban runoff receiving waters (including ponds) probably seldom experience fecal coliform levels less than several hundred counts per 100 mL, compared to discharge concentrations of several thousand counts per 100 mL (EPA 1983). This indicates maximum reductions of about 90 percent, which is certainly significant, but the resulting fecal coliform populations are still high compared to most water quality

standards. Bacteria reductions of about 20 percent may also be expected during runoff events that may last several hours. Sustained high fecal coliform populations may be caused by continued discharges of contaminated baseflows into detention ponds (Pitt and McLean 1986). It is not unusual for baseflows to have fecal coliform levels of several thousand counts per 100 mL (Pitt, *et al.* 1993).

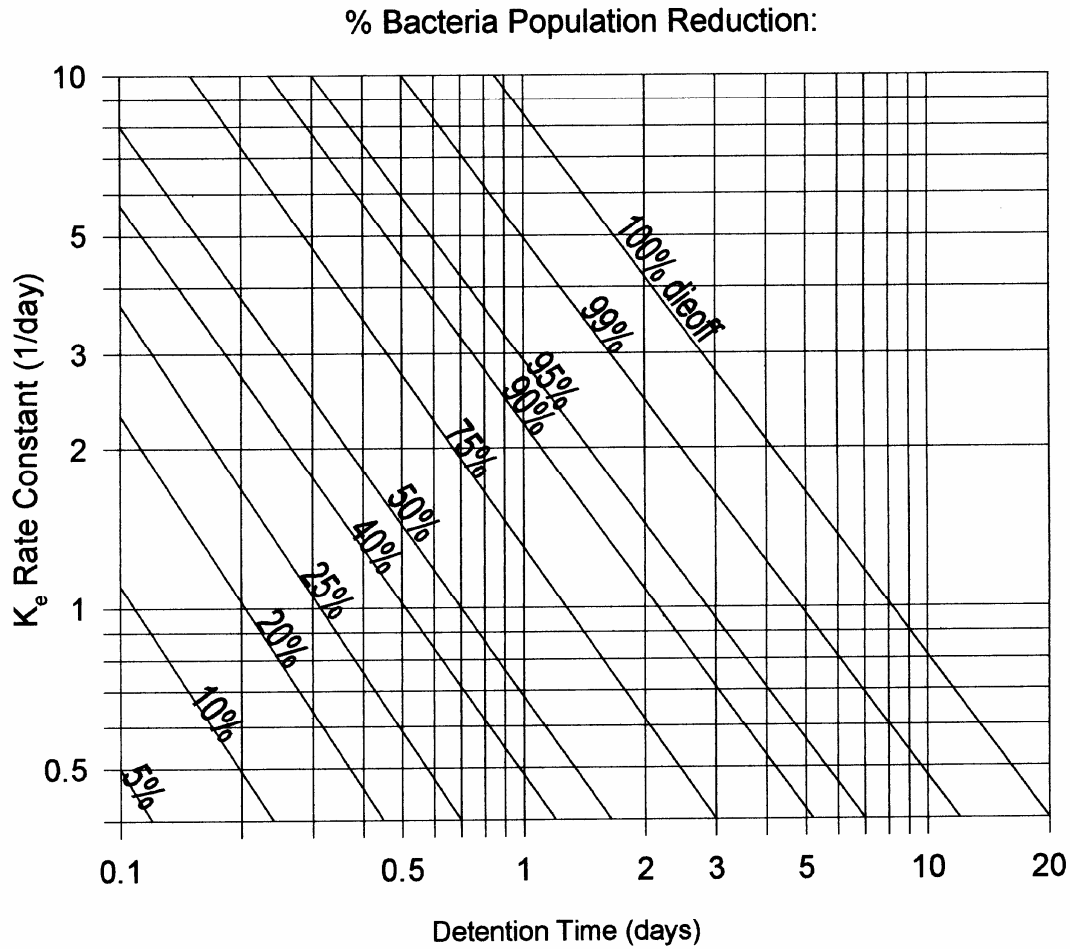

**Figure 30. Chick's law for bacterial dieoff.**

***Design Based on NURP Detention Pond Monitoring Results***

As summarized earlier, several NURP projects investigated the performance of different types of detention ponds. About 150 rain events were monitored at nine ponds located throughout the U.S. The EPA (1983) determined that long-term detention pond performance could be estimated based on geographical location and the ratio of the pond surface area to contributing source area.

Driscoll (1989; and EPA 1986) presented a basic methodology for the design and analysis of wet detention ponds. A pond operates under dynamic conditions when the storage of the pond is increasing with runoff entering the pond and with the stage rising, and when the storage is decreasing when the pond stage is lowering. Quiescent settling occurs during the dry period between storms when storage is constant and when the previous flows are trapped in the pond, before they will be partially or completely displaced by the next storm. The relative importance of the two settling periods depends on the size of the pond, the volume of each runoff event, and the inter-event time between the rains.



Driscoll (1989) produced a summary curve, shown as Figure 31, that relates wet pond performance to the ratio of the surface area of the pond to the drainage area, based on the numerous NURP wet detention pond observations. The NURP ponds were in predominately residential areas and were drained with conventional curb and gutters. This figure indicates that wet ponds from about 0.3 to 0.8 percent of the drainage area should produce about 90% reductions in suspended solids. Southeastern ponds need to be larger than ponds in the Rocky Mountain region because of the much greater amounts of rain and the increased size of the individual events in the southeast. Also, wet ponds intending to remove 90% of the suspended solids need to be about twice as large as ponds with only a 75% suspended solids removal objective.

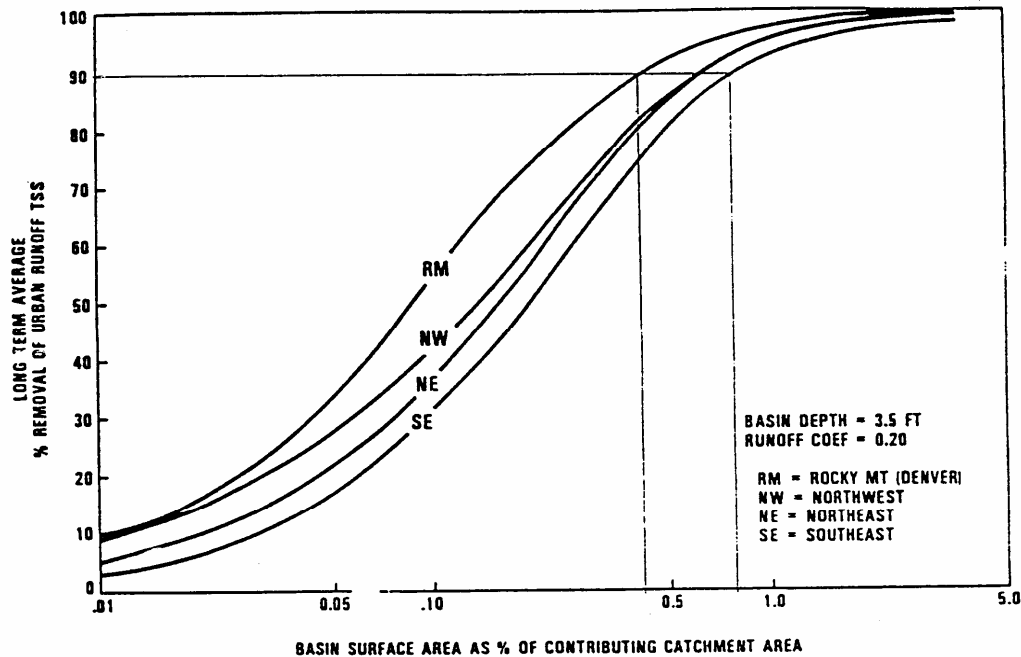

Figure 31. Regional differences in detention pond performance (EPA 1983).

The NURP detention pond monitoring results mostly included residential areas and therefore could not effectively examine the effects of land use on pond performance. Hey and Schaefer (1983), during the West Chicago NURP project in Glen Ellyn, Illinois, prepared Table 11 showing how land uses with large fractions of impervious areas require about twice the pond surface area as suburban residential areas. These ratios are all substantially greater than shown on Figure 31 to provide an extra margin of safety for a broader range of expected rain conditions.

Table 11. Area Required for Wet Detention Ponds for Different Land Uses

Land Use	Percent Impervious	Storage Needed (inches)	Percent of Drainage Area Needed for Detention Storage <sup>1</sup>
Parking Lot	100%	1.0	2.8%
Suburban and Commercial	25	0.6	1.7
Suburban	10	0.5	1.3
Undeveloped	0	0.4	1.1

<sup>1</sup> Assuming an average depth of three feet.  
Source: Hey and Schaefer (1983)

### ***Importance of Reservoir Routing***

The discharged water from a detention pond is simply displaced pond water. In some cases, observed outlet water characteristics during a specific storm cannot be related to the inlet water characteristics. If the storm is small, the volume of water coming into the pond can be substantially less than the resident water in the pond. In these cases, the outlet water is mostly “left-over” water from a previous event or from relatively low volume (but long duration) baseflows that had previously entered the pond since the last storm. However, if the storm is large, then the water being discharged from the pond is mostly related to the specific event. Therefore, analyses of detention pond behavior must consider the relative displacement of pond water. Long-term continuous analyses comparing many adjacent storms resulting in seasonal inlet and outlet discharges of pollutants may be more appropriate than monitoring simple paired samples.

The following discussion on routing includes a fairly simple procedure to examine these pond water displacement considerations and their effects on particulate trapping. The Source Loading and Management Model (SLAMM) and the Detention Pond Analysis model (DETPOND) include a computerized version of the storage-indication method.

### ***Introduction To Storage-Indication Method***

The pond routing calculation procedure presented in the remainder of this section is based on the Natural Resources Conservation Service Technical Release-20 (TR-20) procedures (SCS 1982), as presented by McCuen (1982). The reservoir routing subroutine in TR-20 (RESVOR) is based on the storage equation:

$$I - O = \frac{\Delta S}{\Delta T}$$

where I is the pond inflow and O is the pond outflow. The difference between the inflow and outflow must be equal to  $\Delta S/\Delta T$ , the change in pond storage per unit of time. McCuen presents a series of equations and their solutions that require the preparation of a “storage-indication” curve to produce the pond outflow hydrograph. The storage-indication curve is a plot of pond outflow (O) against the corresponding pond storage at that outflow (S) plus 1/2 of the outflow times the time increment. When the pond outflow hydrograph is developed, the upflow velocity procedure described earlier can be used to estimate pond pollutant removal and peak flow rate reduction performance.

### ***Outflow Rates From Discharge Control Devices***

The first step in using the storage-indication method is to determine the stage-discharge relationship for the pond under study. This relationship (the rating curve) is the pond outflow rate (expressed in cubic feet per second, or cfs) for different pond water surface elevations (expressed in feet). Figures 32 through 34 are approximate rating curves for several common outlet control weir types for water surface elevation ranges up to six feet above the weir inverts. As an example, Figure 32 shows six separate curves for different lengths of rectangular weirs (from two to 18 feet wide). At a water surface elevation of 2.5 feet above the bottom of the weir (stage), not the bottom of the pond, a three foot wide rectangular weir would discharge about 34 cfs, while a 12 foot wide rectangular weir at this same stage would discharge about 150 cfs. For most applications, other stage-discharge rating curves will need to be developed and used, especially for commonly used broad crested weirs or culverts.

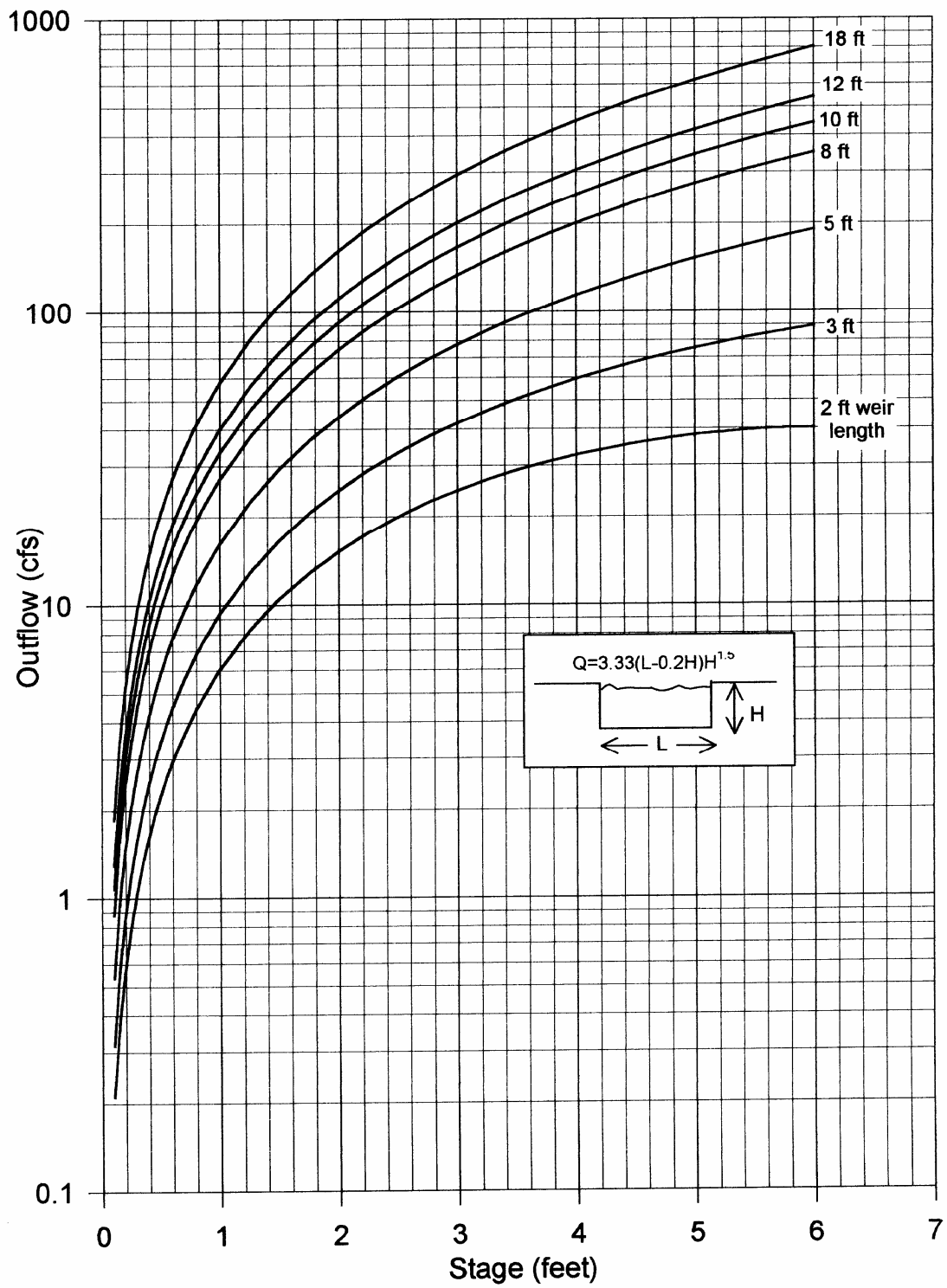

Figure 32. Approximate rating curves for rectangular weirs.

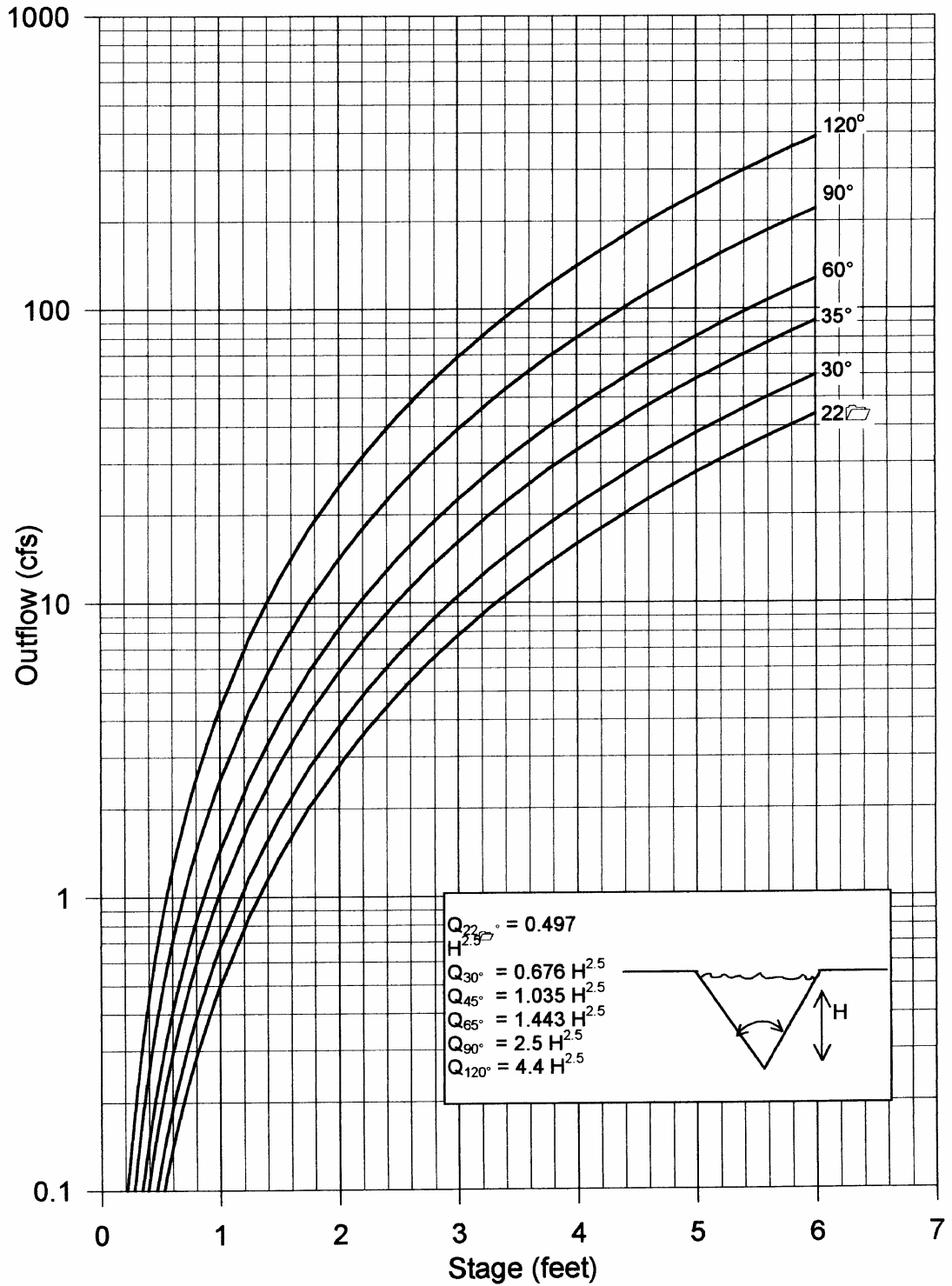

Figure 33. Approximate rating curves for V-notch weirs.

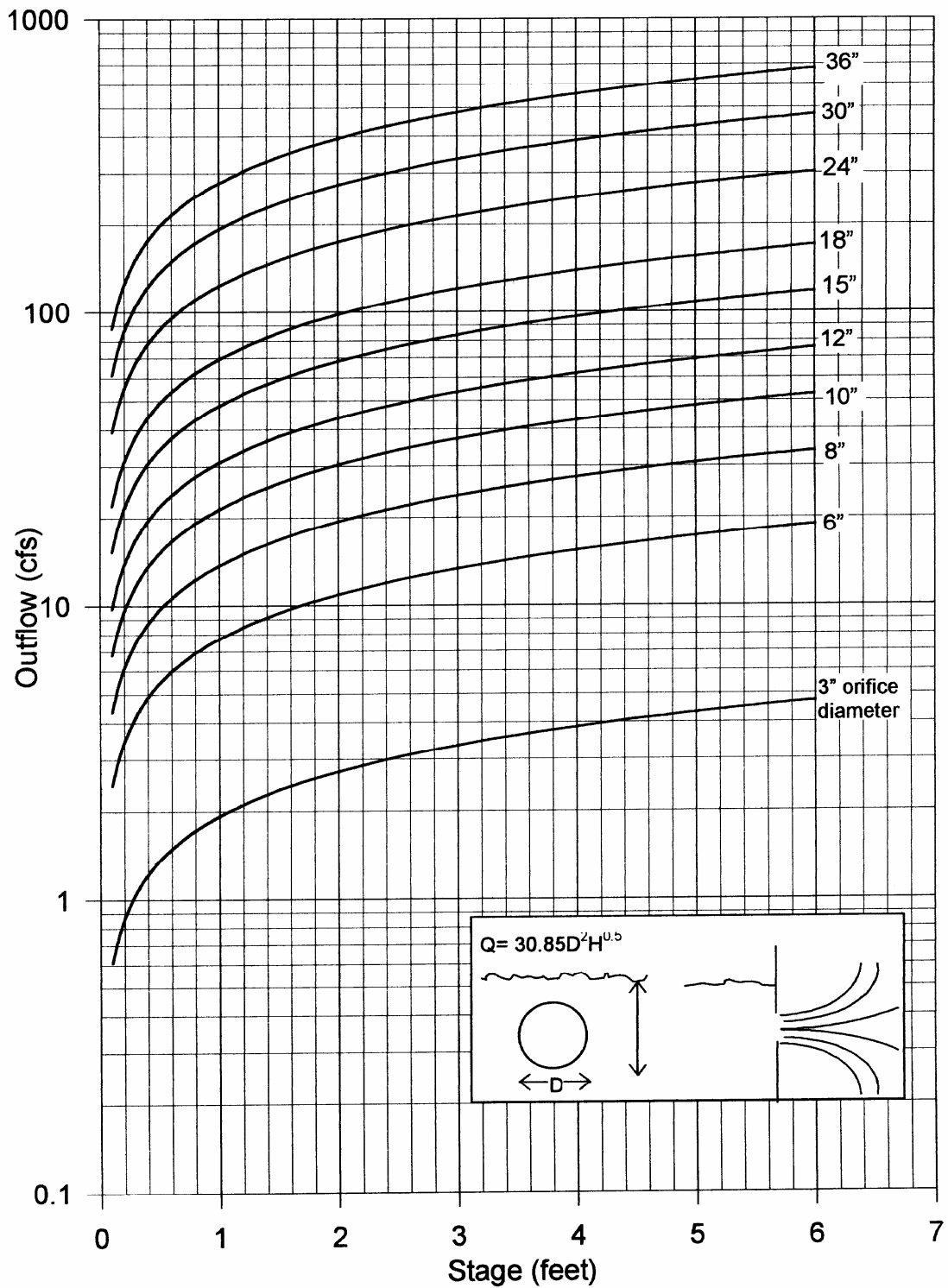
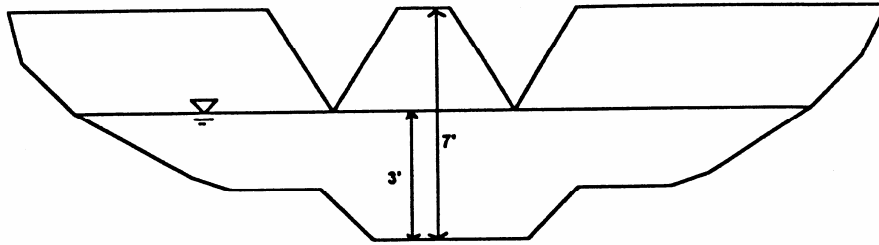

Figure 34. Approximate rating curves for orifice discharges.

### Stage-Area and Storage-Indication Curve Development

The relationship between the pond stage and the surface area for the pond under study is also needed in order to calculate the storage volume available for specific pond stages. Figure 35 is an example stage-area curve developed from topographic maps of the Monroe Street detention pond in Madison, Wisconsin. The normal pond wet surface is at 13 feet (arbitrary datum) and the emergency spillway is located at 16 feet, for a resultant useable stage range of three feet.



**Diagram of Example Pond  
with Two 90 Degree  
V-Notch Weirs**

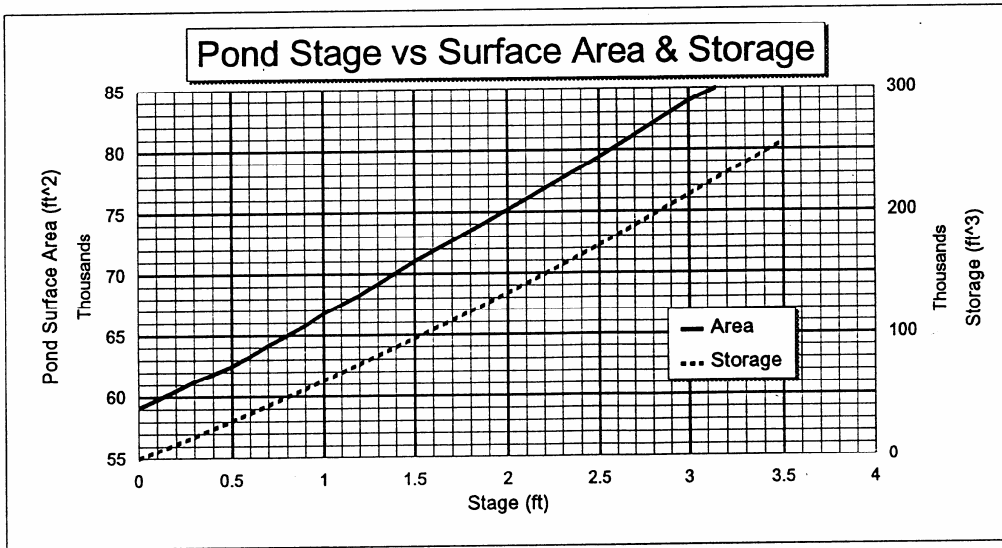

**Figure 35. Pond-stage surface area relationship for example problem.**

Table 12 shows the calculations used to produce the storage-indication figure (Figure 36) for the Monroe St. pond. This example assumes some pond modifications: two 90° V-notch weirs, with a maximum stage range increased to 3.5 feet available before the emergency spillway is activated. The storage calculations assume an initial storage

value of zero at the bottom of the V-notch weirs (13.0 feet). The time increment used in these calculations is ten minutes, or 600 seconds. The storage-indication curve shown as Figure 36 is therefore a plot of pond outflow (cfs) versus pond storage plus 300 (1/2 of 600 seconds) times the outflow rate. The storage-indication figure must also include the stage versus outflow and storage versus outflow curves (also from Table 12).

**Table 12. Calculation of Storage-Indication Relationships for Example Pond and 1.5-Inch, 3-Hour Rain.**

Datum Stage (H) (ft)	Discharge Rate <sup>1</sup> (O) (ft <sup>3</sup> /sec)	Surface Area (ft <sup>2</sup> )	Storage (S) (ft <sup>3</sup> )	S + ½ OΔt (see footnote 2)
0	0	59,100	0	0
0.1	0.016	59,800	5,980	5,985
0.2	0.09	60,500	12,100	12,130
0.3	0.25	61,250	18,375	18,450
0.4	0.51	61,850	24,740	24,890
0.5	0.88	62,520	31,260	31,520
0.6	1.4	63,300	37,980	38,400
0.7	2.1	64,200	44,940	45,570
0.8	2.9	65,000	52,000	52,870
0.9	3.8	65,800	59,200	60,340
1.0	5.0	66,767	66,770	68,270
1.2	7.9	68,300	82,000	84,370
1.5	14	71,000	107,000	111,200
1.8	22	73,500	130,000	136,600
2.0	28	75,148	150,300	158,700
2.5	49	79,400	200,000	214,700
3.0	78	83,928	251,800	275,200
3.5	115	87,500	306,300	340,800

<sup>1</sup> Using two 90° V-notch weirs:  
 $Q = 2(2.5H^{2.5})$

<sup>2</sup>  $S + \frac{1}{2} O \Delta t = S + O (\frac{1}{2} \Delta t) = S + 300 (O)$   
 $\Delta t = 600$  seconds

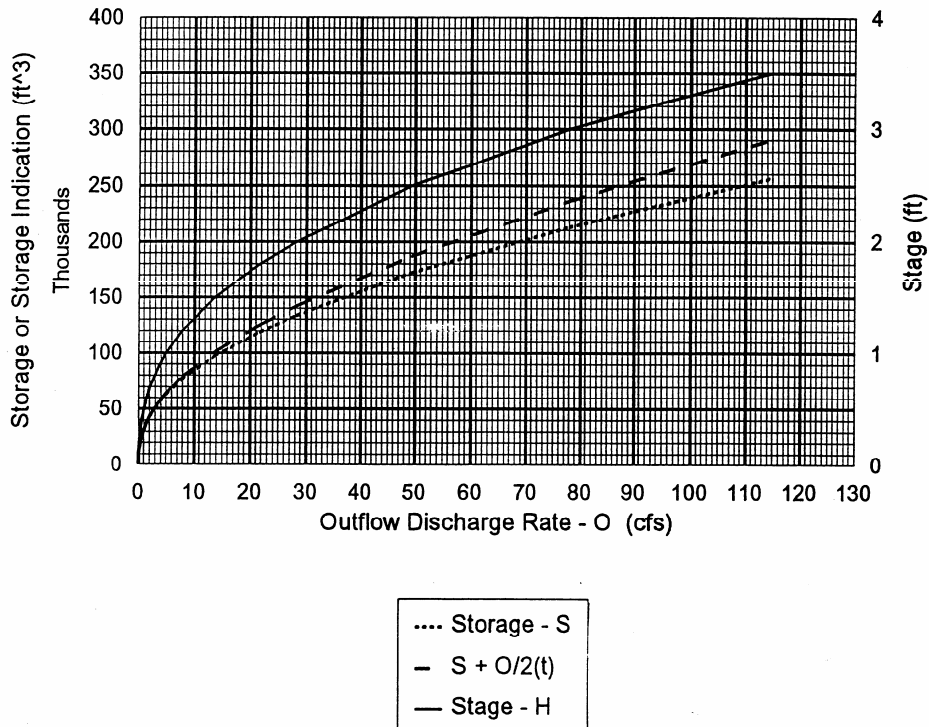

Figure 36. Pond-stage/storage indication curve for example problem.

**Storage-Indication Calculation Procedure**

Table 13 shows the calculations necessary to develop the pond outflow hydrograph and the plot of particle removal, for a triangular inflow hydrograph resulting from a 1.5 inch, 3 hour rain. Columns A through J of this table (to develop the outflow hydrograph and pond surface area) need to be calculated by rows (horizontally), while columns K through O (to calculate the upflow velocity and associated particulate removals) can be calculated vertically, based on the previously calculated column values. It should be noted that columns C through F are offset between the indicated time values and not for the specific times shown in column A. All of the starting values (time zero) in columns B (the beginning inflow rate), G (the beginning outflow rate), H (the pond storage volume above the normal wet pond water surface elevation), and I (the pond stage) are zero for this example.

Table 13a. Pond Performance Calculations for Example 1.5-Inch, 3-Hour Rain

A Time (min)	B Inflow (cfs)	C Average inflow for increment	D Average inflow volume (avg. inflow x time period)	E Previous storage minus incremental outflow $S-0.5(O)\Delta t$	F Previous storage plus incremental outflow $S+0.5(O)\Delta t$	G Outflow (O) (cfs)	H Storage (S) (ft <sup>2</sup> )	I Pond stage (ft)	J Pond surface area (ft <sup>2</sup> )
0	0					0	0	0	59,000
10	9	4.5	2,700	0	2,700	0.01	3,000	0.1	60,000
20	18	13.5	8,100	2,997	11,100	0.09	12,100	0.2	60,400
30	27	22.5	13,500	12,073	25,600	0.51	24,740	0.4	62,000
		31.5	18,900	24,590	43,490				



40	36					1.0	44,000	0.7	64,100
		40.5	24,300	43,700	68,000				
50	45					5.1	66,770	1.0	66,800
		50.0	30,000	65,240	95,240				
60	55					10	95,000	1.4	70,000
		59.5	35,700	93,500	129,200				
70	64					19	125,000	1.8	73,500
		68.5	41,100	119,300	160,400				
80	73					30	155,000	2.1	76,000
		77.5	46,500	146,000	192,500				
90	82					41	180,000	2.3	77,800
		86.5	51,900	167,700	219,600				
100	91					52	205,000	2.6	80,200
		95.5	57,300	189,400	246,700				
110	100					63	225,000	2.8	81,800
		95.5	57,300	206,100	263,400				
120	91					71	240,000	2.9	82,700
		86.5	51,900	218,700	270,600				
130	82					77	250,000	3.0	83,700
		77.5	46,500	226,900	273,400				
140	73					78	250,000	3.0	83,800
		68.5	46,100	226,600	267,700				
150	64					73	245,000	2.9	82,700
		59.5	35,700	223,100	258,800				
160	55					69	240,000	2.8	81,800
		50.0	30,000	219,300	249,300				
170	45					65	230,000	2.7	81,800
		40.5	24,300	210,500	234,800				
180	36					58	220,000	2.6	80,200
		31.5	18,900	202,600	221,500				
190	27					52	205,000	2.5	79,400
		22.5	13,500	189,400	202,900				
200	18					44	185,000	2.4	78,600
		13.5	8,100	171,800	180,000				
210	9					36	170,000	2.2	76,900
		4.5	2,700	159,200	162,000				
220	0					29	152,000	2.0	75,200
		0	0	143,300	143,300				
230	0					22	135,000	1.8	73,500
		0	0	128,400	128,400				
240	0					18	125,000	1.7	72,700
		0	0	119,600	119,600				

**Table 13a. Pond Performance Calculations for Example 1.5-Inch, 3-Hour Rain (Continued).**

<b>A</b> Time (min)	<b>B</b> Inflow (cfs)	<b>C</b> Average inflow for increment	<b>D</b> Average inflow volume (avg. inflow x time period)	<b>E</b> Previous storage minus incremental outflow $S-0.5(O)\Delta t$	<b>F</b> Previous storage plus incremental outflow $S+0.5(O)\Delta t$	<b>G</b> Outflow (O) (cfs)	<b>H</b> Storage (S) (ft <sup>2</sup> )	<b>I</b> Pond stage (ft)	<b>J</b> Pond surface area (ft <sup>2</sup> )
250	0					16	115,000	1.6	71,900
		0	0	110,200	110,200				
260	0					13	105,000	1.5	71,000
		0	0	101,100	101,100				
270	0					11	100,000	1.4	70,000
		0	0	96,700	96,700				
280	0					10	95,000	1.3	69,200

		0	0	92,000	92,000				
290	0					9	90,000	1.3	69,200
		0	0	87,300	87,300				
300	0					8	85,000	1.2	68,500
	Maximum = 100 cfs		Total = 660,000			Max. = 78 Total = 981			

**Table 13b. Particle Removal Performance Calculations for Example 1.5-inch, 3-hr Rain**

A Time (min.)	B Inflow (cfs)	G Outflow (O) (cfs)	J Pond surface area (ft <sup>2</sup> )	K Upflow velocity (ft/sec)	L Critical particle size (μm)	M Weighted particle size (outflow x size)	N Percent suspended solids control	O Weighted control (outflow x control)
0	0	0	59,000	0	-	0	100	0
10	9	0.01	60,000	$1.7 \times 10^{-7}$	0.3	0.003	100	1
20	18	0.09	60,400	$1.5 \times 10^{-6}$	0.6	0.05	100	9
30	27	0.51	62,000	$8.2 \times 10^{-5}$	1.3	0.66	99	50
40	36	1.0	64,000	$1.6 \times 10^{-5}$	1.8	1.8	98	98
50	45	5.1	66,800	$7.6 \times 10^{-5}$	3.8	19.4	91	464
60	55	10	70,000	$1.4 \times 10^{-4}$	5.1	51	88	880
70	64	19	73,500	$2.6 \times 10^{-4}$	7	133	84	1,596
80	73	30	76,000	$4.0 \times 10^{-4}$	8	240	82	2,460
90	82	41	77,800	$5.3 \times 10^{-4}$	10	410	78	3,200
100	91	52	80,200	$6.5 \times 10^{-4}$	11	572	75	3,900
110	100	63	81,800	$7.7 \times 10^{-4}$	12	756	73	4,600
120	91	71	82,700	$8.6 \times 10^{-4}$	12	852	73	5,180
130	82	77	83,700	$9.2 \times 10^{-4}$	13	1,000	71	5,470
140	73	78	83,800	$9.3 \times 10^{-4}$	13	1,010	71	5,540
150	64	73	82,700	$8.8 \times 10^{-4}$	13	949	71	5,180
160	55	69	81,800	$8.4 \times 10^{-4}$	12	830	73	5,040
170	45	65	81,800	$8.0 \times 10^{-4}$	12	780	73	4,750
180	36	58	80,200	$7.2 \times 10^{-4}$	11	638	75	4,350
190	27	52	79,400	$6.6 \times 10^{-4}$	11	572	75	3,900
200	18	44	78,600	$5.6 \times 10^{-4}$	10	440	78	3,430
210	9	36	76,900	$4.7 \times 10^{-4}$	9	320	80	2,880
220	0	29	75,200	$3.9 \times 10^{-4}$	8	232	82	2,380
230	0	22	73,500	$3.0 \times 10^{-4}$	7.5	170	83	1,830
240	0	18	72,700	$2.5 \times 10^{-4}$	6.5	120	85	1,530
250	0	16	71,900	$2.2 \times 10^{-4}$	6	96	86	1,380
260	0	13	71,000	$1.8 \times 10^{-4}$	6	78	86	1,120
270	0	11	70,000	$1.6 \times 10^{-4}$	5.5	61	88	968
280	0	10	69,200	$1.5 \times 10^{-4}$	5.3	53	88	880
290	0	9	69,200	$1.3 \times 10^{-4}$	5	45	89	800
300	0	8	68,500	$1.2 \times 10^{-4}$	4.7	38	89	710
						Total = 10,468		Total = 74,576

Peak reduction factor:  $PRF = 1 - [(Q_o \text{ max}) / (Q_i \text{ max})] = 1 - [(78) / (100)] = 0.22$

Weighted average critical particle size =  $[\text{total (outflow x size)}] / [\text{total (outflow)}] = 10,468 / 981 = 10.7 \mu\text{m}$

Weighted average suspended solids control =  $[\text{total (outflow x control)}] / [\text{total (outflow)}] = 74,576 / 981 = 76\%$

Column A shows the times at ten minute increments for five hours (300 minutes) since the start of the runoff.

Column B is the pond inflow hydrograph (instantaneous flow rates at each time increment). The calculation of the inflow hydrograph is shown on Table 14. Other events that will be considered in a future example problem are also described on this table. The average inflow runoff rate can be estimated using one of the methods given in the earlier

hydrology discussion. Table 14 shows how the example Monroe Street detention pond watershed is divided into these three major land surfaces and how the average runoff rates are calculated for the storms under consideration.

**Table 14. Rain and Inlet Hydrograph Characteristics for Example**

Rain volume (in.)	Rain intensity (in/hr)	Rain duration (hrs)	Return frequency (years)	Average cfs/acre		Average cfs (for total area)		Total avg. flow (cfs)	Total flow volume (10 <sup>3</sup> ft <sup>3</sup> )	Runoff duration (hrs)	Peak 5-min. flow (cfs)	Time to peak flow (hrs)	Total storm volume as a fraction of pond base storage <sup>2</sup>
				Imperv.	Pervious	Imperv.	Pervious						
0.1	0.03	3	<1	0.013	0.0001	0.006	0.01	1.2	16	3.6	2.4	1.8	0.1
0.5	0.17	3	<1	0.16	0.0035	0.08	0.4	13	180	3.6	26	1.8	1.0
0.9	1.8	0.5	1	1.8	0.06	0.45	8	150	320	0.6	300	0.3	1.8
1.1	1.1	1	1	1.0	0.045	0.5	6	100	430	1.2	200	0.6	2.4
1.3	0.7	2	1	0.7	0.03	0.35	4	70	610	2.4	140	1.2	3.4
1.5	0.5	3	1	0.5	0.025	0.25	3	50	640	3.6	100	1.8	3.6
1.7	0.3	6	1	0.3	0.015	0.15	2	30	780	7.2	60	3.6	4.3
2.0	0.2	12	1	0.2	0.012	0.10	2	20	1,100	14	40	7	6.1
2.3	0.1	24	1	0.1	0.006	0.05	1	10	1,100	29	20	14.5	6.1
5.5	0.23	24	100	0.23	0.05	0.12	6	28	2,900	29	56	14.5	16

Areas for different land cover types:

Impervious area: 63 acres

Pervious area: 126 acres

Impervious area draining to pervious area: 63 acres

Pond base storage (normally wet volume) is about 180,000 ft<sup>3</sup>.

Urban hydrographs can be represented with a simple triangular shape (as shown on Figure 37), with a peak runoff rate equal to about twice the average runoff rate and with the runoff duration about 20 percent longer than the rain duration (Pitt and McLean 1986). This simplification is reasonable for most small to intermediate rains, especially when the effects of a relatively large series of individual rains on a pond are to be evaluated statistically, instead of describing the pond performance associated with a single “design” storm. The peak flow rate in this example (1.5 inch, 3 hour rain) is therefore assumed to be about 100 cfs and occurs at 1.8 hours into the runoff period. Of course, any hydrograph shape can be used in these calculations. This triangular shape is used in SLAMM as a simplification when evaluating very large numbers of storms. However, DETPOND is a more detailed detention pond program that allows any runoff hydrograph to be evaluated (if manually entered). Pond leakage, groundwater intrusion, evaporation, or any other additional water losses or inflows can be added or subtracted from the pond inflow hydrograph, if desired, and are included in the computer programs.

Column C shows the average runoff rates (cfs) for the two adjacent time increments. Column D shows the incremental incoming runoff volume (cubic feet) for each time increment (average inflow runoff rate, from column C, times the increment time, or 600 seconds). Column E shows the previous storage volume minus one-half of the outflow rate times the time increment (one-half of the outflow volume). The first value shown in this column (for the increment 0 to 10 minutes) is zero because the previous storage and outflow rate values (for time 0) are both 0:  $0 - 1/2 (0) (600) = 0 - 0 = 0$ . The second value in column E (for the time increment 10 to 20 minutes) is:  $3,000 - 1/2 (0.01) (600) = 3,000 - 3 = 2,997$ . Before this second value in column E can be calculated, the previous outflow rate (O) and pond storage (S) values (for time 10 minutes) must be calculated.

Column F is the Column E value plus the Column D value (increment inflow). The first value shown in Column F is therefore equal to the first value shown in Column D (2700 for this example). The second value in column F (for the time increment 10 to 20 minutes) is  $8,100 + 2,997 = 11,100$ .

Column G (pond outflow rate, O) and column H (pond storage, S) also start as 0 values at time 0. Later values in these columns are obtained from the storage-indication curve, using the column F value for the previous time increment. The 2,700 value in column F (representing  $S + 1/2 (O) (dt)$ ) is used in Figure 36 (or Table 12) to obtain a corresponding pond outflow rate of about 0.01 cfs and a pond storage volume of about 3,000 cubic feet.

The stage values in column I are obtained from the stage-discharge curve (shown in tabular form on Table 12 for this example), using the corresponding outflow rates from column G. The pond surface area values are obtained from the stage-area curve (Figure 35), using the corresponding stage values from column I.

The particle removal calculations are based on the previously described upflow velocity method, using the “instantaneous” pond surface area values (from column J) and outflow rate values (from column G). Column K shows the upflow velocities (in feet per second) calculated by dividing the outflow rate values (column G) by the corresponding pond surface area values (from column J). Column L shows the sizes of the critical particles (the smallest particles that would settle below the bottom of the outfall structure and therefore be “retained”) and are estimated from Figure 25 based on these upflow velocities. Column M shows the outflow rate weighting of these particle sizes (critical particle size times the outflow rate). In this example, the “flow-weighted” critical particle size is about 11  $\mu\text{m}$ .

Column N shows the estimated particulate residue percentage removals, based on a particle size distribution from Figure 36. Column O shows the flow-weighted calculations. For this example, a particulate residue reduction of about 75 percent may be expected.

The results of these calculations can be effectively presented on several graphs. Figure 37 compares the inlet and outlet hydrographs, Figure 38 shows the stage elevations above the permanent pool and the upflow velocities, and Figure 39 shows the critical particle sizes controlled and the estimated percentage control of particulate residue for this example.

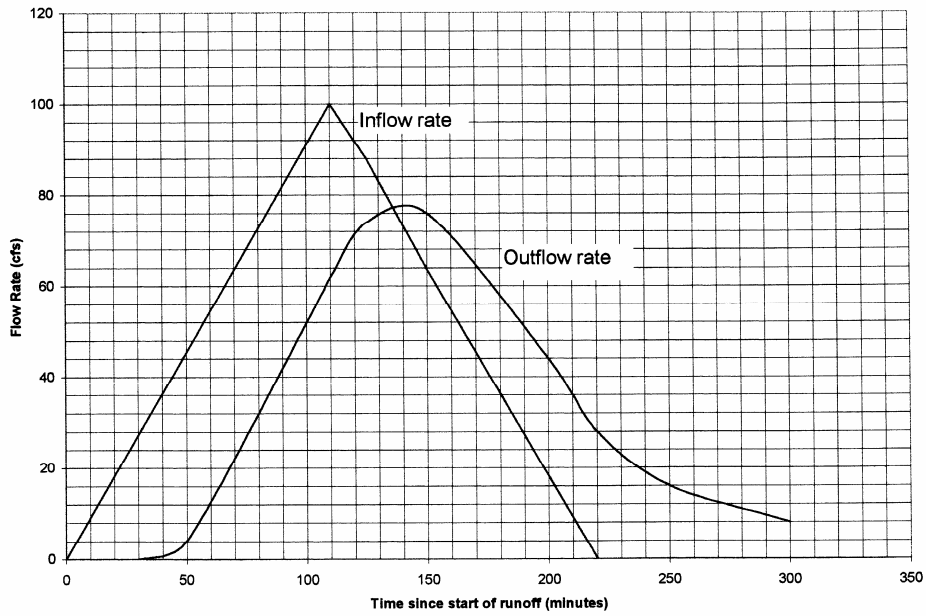

Figure 37. Inflow and outflow hydrographs for example problem.

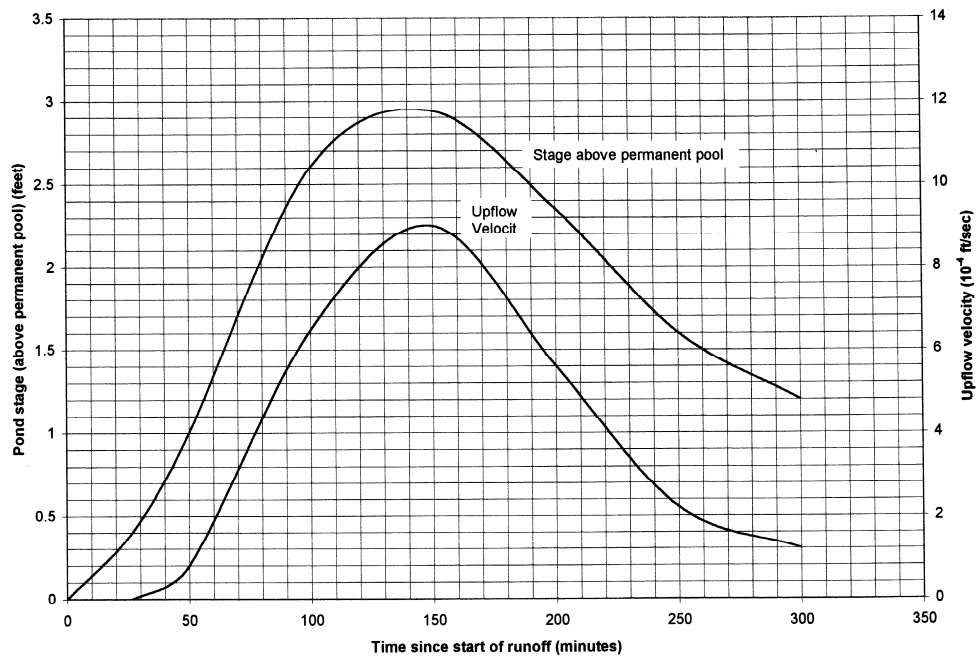

Figure 38. Stage and upflow velocity plots for example problem.

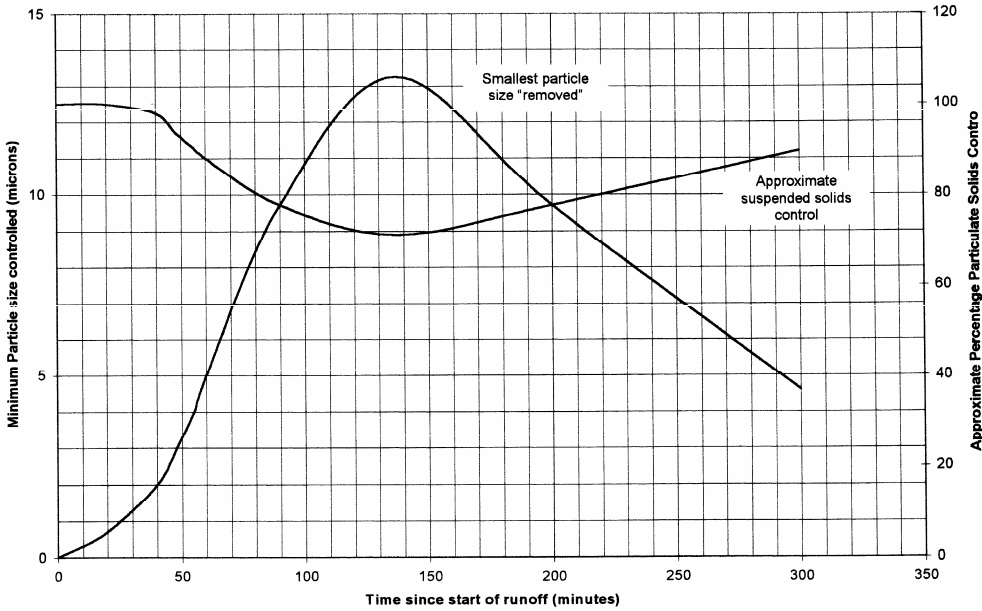

Figure 39. Particle sizes and percentage suspended solids removed for example problem.

### Selecting Outflow Control Devices To Meet Water Quality Objectives

A simple analysis procedure can be used to guide the selection of an outflow control device for a given stage-surface area relationship for a potential pond location and desired particle size control objective. The definition of upflow velocity (outflow rate divided by surface area) allows the simple evaluation of detention pond performance for any pond stage. Similarly, if the pond stage-surface area relationship is known for a potential pond location, an outfall device can be selected to obtain control of critical particle sizes.

Tables 15 through 18 provide a quick method of selecting appropriate outfall devices for a potential pond location. These tables indicate the minimum amount of pond surface area needed at each stage to provide a five  $\mu\text{m}$  critical control level for a variety of conventional outfall devices. Table 18 presents multipliers to adjust the minimum areas for other critical particle sizes. In order to improve the pond performance by selecting a two  $\mu\text{m}$  critical particle size instead of five  $\mu\text{m}$ , the pond surface area would have to be increased by about 6.7 times. If the critical particle size was increased to ten  $\mu\text{m}$ , then the required pond surface would be reduced by about 0.27 compared to the pond surface areas needed for five  $\mu\text{m}$  control.

Table 15. Surface Area Requirements for 5- $\mu\text{m}$  Particle Size Control for Various V-notch Weirs.

Head (ft)	Flow (cfs)	22.5°	Reqd.	Flow (cfs)	30°	Reqd.	Flow (cfs)	45°	Reqd.
		Storage (ac-ft)	area (acres)		Storage (ac-ft)	area (acres)		Storage (ac-ft)	area (acres)
0.5	0.1	<0.01	0.01	0.1	<0.01	0.02	0.2	<0.01	0.03
1	0.5	0.03	0.1	0.7	0.05	0.1	1.0	0.05	0.2
1.5	1.4	0.1	0.2	1.9	0.2	0.3	2.9	0.2	0.5
2	2.8	0.3	0.5	3.8	0.3	0.7	5.9	0.6	1.0
3	7.8	1.2	1.4	11	1.6	1.8	16	1.6	2.8
4	16	3.3	2.8	22	4.4	3.8	33	5.9	5.8
5	28	7.2	4.9	38	9.6	6.6	58	14	10
6	44	14	7.7	60	18	10	91	27	16
	Flow (cfs)	60° Storage	Reqd. area	Flow (cfs)	90° Storage	Reqd. area	Flow (cfs)	120° Storage	Reqd. area

	(ac-ft)	(acres)	(ac-ft)	(acres)	(ac-ft)	(acres)	(ac-ft)	(acres)	
0.5	0.3	<0.01	0.05	0.4	0.02	0.08	0.8	0.04	0.1
1	1.4	0.07	0.3	2.5	0.2	0.4	4.4	0.3	0.8
1.5	4.0	0.3	0.7	6.9	0.6	1.2	12	1.7	2.1
2	8.2	0.8	1.4	14	1.5	2.5	25	3.3	4.4
3	28	3.5	3.9	39	6.2	6.8	69	12	12
4	46	9.5	8.1	80	17	14	140	30	25
5	81	21	14	140	36	25	250	69	43
6	130	39	22	220	67	39	390	120	68

**Table 16. Surface Area Requirements for 5- $\mu$ m Particle Size Control for Various Rectangular Weirs.**

Head (ft)	Flow (cfs)	2 ft.	Reqd.	Flow (cfs)	5 ft.	Reqd.	Flow (cfs)	10 ft.	Reqd.
		Storage (ac-ft)	area (acres)		Storage (ac-ft)	area (acres)		Storage (ac-ft)	area (acres)
0.5	2.1	0.10	0.4	5.7	0.3	1.0	12	0.5	2.0
1	6	0.5	1.1	16	1.2	2.8	33	2.4	5.7
1.5	10	1.2	1.8	29	3.2	5.0	59	6.3	10
2	15	2.3	2.6	43	6.4	7.6	90	13	16
3	24	5.7	4.2	80	17	14	160	35	29
4	32	11	5.6	110	34	20	250	71	43
5	37	17	6.5	150	47	26	340	120	59
6	39	23	6.9	190	77	33	430	190	75
	Flow (cfs)	15 ft.	Reqd.	Flow (cfs)	20 ft.	Reqd.	Flow (cfs)	30 ft.	Reqd.
		Storage (ac-ft)	area (acres)		Storage (ac-ft)	area (acres)		Storage (ac-ft)	area (acres)
0.5	17	0.8	3.0	23	1.0	4.1	35	1.5	6.1
1	49	3.7	8.6	66	5.1	12	99	7.3	17
1.5	90	9.9	16	120	13	21	180	20	32
2	140	20	24	190	27	32	280	40	49
3	250	54	44	340	72	59	510	110	89
4	380	110	66	510	150	89	780	220	140
5	520	190	91	710	250	120	1100	390	190
6	680	290	120	920	390	160	1400	610	250

**Table 17. Surface Area Requirements for 5- $\mu$ m Particle Size Control for Various Drop-tube Structures.**

Head (ft)	Flow (cfs)	8"	Reqd.	Flow (cfs)	12"	Reqd.	Flow (cfs)	18"	Reqd.
		Storage (ac-ft)	area (acres)		Storage (ac-ft)	area (acres)		Storage (ac-ft)	area (acres)
0.5	0.5	0.02	0.09	0.9	0.04	0.2	1.6	0.07	0.3
1	0.7	0.07	0.1	2.2	0.2	0.4	4.4	0.3	0.8
1.5	0.7	0.1	0.1	2.2	0.4	0.4	6.5	0.8	1.1
2	0.7	0.2	0.1	2.2	0.6	0.4	6.5	1.4	1.1
3	0.7	0.3	0.1	2.2	0.9	0.4	6.5	2.5	1.1
4	0.7	0.4	0.1	2.2	1.3	0.4	6.5	3.6	1.1
5	0.7	0.6	0.1	2.2	1.7	0.4	6.5	4.7	1.1
6	0.7	0.7	0.1	2.2	2.1	0.4	6.5	5.8	1.1
	Flow (cfs)	24"	Reqd.	Flow (cfs)	30"	Reqd.	Flow (cfs)	36"	Reqd.
		Storage (ac-ft)	area (acres)		Storage (ac-ft)	area (acres)		Storage (ac-ft)	area (acres)
0.5	1.6	0.07	0.3	1.9	0.08	0.3	2.0	0.09	0.4
1	5.6	0.4	1.0	6.3	0.4	1.1	7.2	0.5	1.3
1.5	11	1.1	1.8	13	1.3	2.3	16	1.5	2.8
2	14	2.1	2.4	21	2.8	3.7	27	3.4	4.7
3	14	4.5	2.4	25	6.9	4.4	42	9.4	7.3
4	14	6.9	2.4	25	11	4.4	42	17	7.3
5	14	9.3	2.4	25	16	4.4	42	24	7.3
6	14	12	2.4	25	20	4.4	42	31	7.3



**Table 18. Corrections for Needed Surface Areas for Particle Size Controls other than 5 µm.**

Particle size for control (µm)	Typical percentage of particles larger than indicated size	Particle settling rate (cm/sec)	Required area multiplier, compared to 5 µm
1	100	$1.5 \times 10^{-4}$	27
2	94	$6 \times 10^{-4}$	6.7
5	88	$4 \times 10^{-3}$	1.0
10	78	$1.5 \times 10^{-2}$	0.27
20	62	$6 \times 10^{-2}$	0.067
40	47	$2 \times 10^{-1}$	0.02
100	28	$8 \times 10^{-1}$	0.005

If a site had a surface area of 3 acres at two feet above the lowest invert level, a number of outlet devices could be used to provide at least five µm critical control:

- all V-notch weirs from 22.5° through 90° (but not 120°)
- only a 2 foot long rectangular weir
- all pipes from 8" to 24"

Obviously, all stage levels have to be examined and the most critical device selected that provides the desired level of control. In a similar manner, it would be possible to specify the shape of a pond (area versus stage) to closely match the natural topography with minimal required grading by selecting an outfall structure that provides close to the required outfall rates.

### **Wet Pond Design Criteria for Water Quality**

A wet detention pond performance specification for water quality control needs to result in a consistent level of protection for a variety of conditions, and to allow a developer a large range of options to best fit the needs of the site. It must also be easily evaluated by the reviewing agency and be capable of being integrated into the complete stormwater management program for the watershed. It should have minimal effects on the hydraulic routing of stormwater flows, unless a watershed-wide hydraulic analyses is available that specifies the specific hydraulic effects needed at the specific location.

The following suggested specifications should meet these objectives under most conditions. However, the specific pond sizes should be confirmed through continuous long-term simulations using many years of actual rainfall records for the area of interest (such as possible by using DETPOND). These guidelines should therefore be considered as a starting point and modified for specific local conditions. As an example, it may be desirable to provide less treatment than suggested by the following guidelines (Vignoles and Herremans 1996). The following guidelines were developed by Pitt (1993a and 1993b), based on literature information and on his personal experience.

1) The wet pond should have a minimum water surface area corresponding to land use, and desired pollutant control. The following values were extrapolated from extensive wet detention pond monitoring, mainly the EPA's NURP (EPA 1983) studies:

Percent of Drainage Area Required as Pond for:

Land Use	5 µm control	20 µm control
Totally paved areas	3.0 percent	1.1 percent
Freeways	2.8	1.0
Industrial areas	2.0	0.8

Commercial areas	1.7	0.6
Institutional areas	1.7	0.6
Residential areas	0.8	0.3
Open space areas	0.6	0.2
Construction sites	1.5	0.5

Two levels of control are shown, corresponding to the control of particles greater than 5 µm and 20 µm. For most stormwater facilities, these would correspond to annual suspended solids controls of about 90 percent for the 5 µm particle size, and about 65 percent for the 20 µm particle size. These values are based upon early work done by Gene Driscoll for NURP (EPA 1983). During NURP, the use of stormwater detention ponds in residential areas was investigated. Ponds having surface areas between 0.5 and 1 percent of the drainage areas were found to provide about 90 percent control. As the runoff changes because of other land uses besides residential areas, the size of the wet pond must correspondingly change. These values are based on expected runoff volumes for typical development conditions and would therefore vary for different development practices (especially if drained using grass swales, or if have extensive infiltration practice).

2) The pond freeboard storage should be equal to the runoff associated with a 1.25 inch rain for the land use and development type. It should be noted that this storage volume is associated with the runoff volume from a specific type of rain and not for a set runoff volume. This has the benefit of providing the same level of control for all land uses. As an example, many ordinances require capture and treatment of the first 0.5 inch, or 1 inch, of runoff for an area. Unfortunately, this has the effect of providing very uneven levels of control because of different rainfall-runoff characteristics for different land uses. As an example, a residential area may require a rain of about 1.50 inches to produce 0.5 inches of runoff. However, a commercial area, such as a strip commercial development, would only require a rain of about 0.6 inches to produce 0.5 inches of runoff. It is obvious that the residential area is providing treatment for a much more severe rain, with a correspondingly greater level of annual control, compared to the commercial area. By requiring a set amount of control associated with a rain having the same re-occurrence interval, a more consistent effort and benefit is obtained throughout the community.

The following table summarizes the approximate runoff depths associated with 1.25 inches of rain for several curb and gutter drained land uses, based on Pitt's (1987) small storm hydrology procedures:

Land Use	Sandy Soil	Clayey Soil
Freeways	0.35	0.40
Totally paved area	1.1	1.1
Industrial	0.85	0.9
Commercial	0.75	0.85
Schools	0.2	0.4
Low density residential	0.1	0.3
Medium density residential	0.15	0.35
High density residential	0.2	0.4
Developed parks	0.5	0.6
Construction sites	0.5	0.6

Pitt (1987) found that currently used urban runoff volume prediction methods commonly result in inaccurate runoff volumes for the common small storms that are most responsible for annual pollutant discharges in urban areas. For sandy soil areas, this table shows that the runoff volume associated with 1.25 inches of rain can vary from a low of 0.1 inch for low density residential areas to a high of 1.1 inch for totally paved areas, such as a parking lot. The difference in runoff volumes for different land uses having sandy or clay soil conditions varies much more for land uses having larger amounts of pervious surfaces. For areas having less amounts of pervious surfaces, the runoff differences produced by similar land use areas for these different soil conditions varies less. If an area is drained with grass swales, has an unusual amount of disconnected roofs, or has extensive upland infiltration controls, then the runoff volume associated with a 1.25 inch rain would be much less than shown in the above table.

3) The selection of the outlet device for the wet detention pond. This outlet device must be selected based upon the desired pollutant control at every specific pond stage in the wet detention pond. This specification regulates the detention time periods and the "draining" period to produce consistent removals for all rains. The ratio of outlet flow

rate to pond surface area for each stage value needs to be at the most  $0.00013 \text{ ft}^3 / \text{sec}/\text{ft}^2$  for  $5 \mu\text{m}$  (about 90 percent annual) control and  $0.002 \text{ (ft}^3/\text{sec}/\text{ft}^2)$  for  $20 \mu\text{m}$  (about 65 percent annual) control. In practice, the desired pond surface area to stage relationship (simply the “shape” of the hole) is compared to the minimum surface areas needed at each stage for various candidate outlet structures. As an example, the following list summarizes the minimum surface areas needed for  $5 \mu\text{m}$  particle control for different stage values. Also shown are the freeboard storage values below each elevation:

stage feet	45° V-notch		90° V-notch		24” pipe	
	storage acre-ft	surface acres	storage acre-ft	surface acres	storage acre-ft	surface acres
0.5	<0. 01	0.032	0.02	0.08	0.07	0.28
1.0	0.05	0.18	0.15	0.44	0.39	0.98
1.5	0.22	0.5	0.56	1.2	1.1	1.8
2.0	0.60	1.0	1.5	2.5	2.1	2.4
3.0	1.6	2.8	6.2	6.8	4.5	2.4
4.0	5.9	5.8	17	14	6.9	2.4
5.0	14	10	36	25	9.3	2.4
6.0	27	16	67	39	12	2.4

The large stages above the normal wet pond depth may result in unsafe conditions for most wet detention ponds. A maximum depth of about 3 feet above the normal wet pond depth is recommended.

The selection of the outlet control device is based upon the concept of surface overflow rate. The surface overflow rate is equivalent to the settling velocity of a critical particle size. Particles that have greater settling velocities than the surface overflow rate will theoretically be retained in the detention pond. The surface overflow rate is defined as the ratio between the instantaneous discharge and the pond surface area. The advantage of using surface overflow rate as a design criteria for detention ponds arises from the fact that flows to a detention pond are very irregular. Surface overflow rate is equivalent to the ratio of detention time to pond depth. Unfortunately, the use of detention time alone, as commonly used in many ordinances and design guidelines, is not adequate to describe theoretical settling. In addition, detention time is very difficult to define for a stormwater detention pond because of the highly variable flow rates. However, the use of surface overflow rate works well because the ratio of discharge to surface area is known, or can be selected, for every pond stage. At any depth in a detention pond, the surface area is known, based upon the shape of the pond. The selection of a discharge device is therefore made simple because it must provide less than the critical discharge rate for each stage, and corresponding surface area.

Figure 40 is a schematic showing a cross section of the pond. The area below the invert of the major control device is the dead storage and is provided to minimize scour of the retained particulates. The water quality storage volume in the detention pond is the volume associated with the runoff associated with a 1.25 inch rain. The topmost layer in the detention pond is additional storage that is provided for drainage benefits. This storage would be provided (with the appropriate additional outlet structure) only if a basin-wide hydraulic analyses has been conducted to insure that inappropriate interferences of the different flood hydrographs would not occur. Also, it is important to note that an emergency spillway must also be provided above the water quality storage area. Therefore, the additional storage for drainage benefits as shown in this figure would at least be provided to cover the range of stage of the emergency spillway.

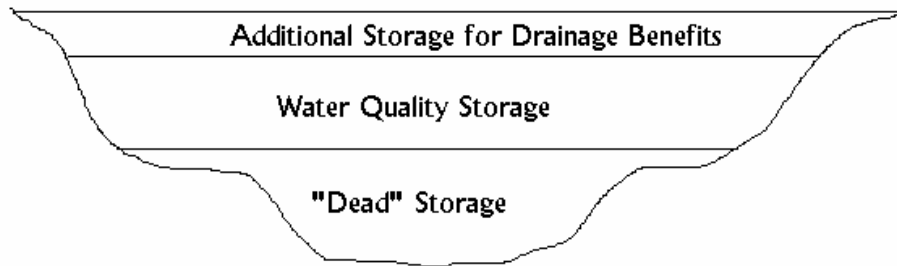

**Figure 40. Cross-section of pond showing water quality storage portion**

4) The ponds must also be constructed according to specific design guidelines to insure the expected performance and adequate safety. The guidelines need to specify such things as pond depth, side slopes, vegetation, and shape.

These procedures will result in the largest storms that do not enter the secondary spillway to have treatment levels equal to the critical particle size specified. As an example, the above calculations focus on the 5  $\mu\text{m}$  particle, at least, being controlled at all stage depths of the primary outfall structures in order to provide 90 percent annual control of suspended solids. The outfall device is selected to provide an outfall rate no greater than a critical value, that when divided by the pond surface area at that stage, will be no larger than the settling rate of the critical particle size. In almost all cases, the critical stage will be at the top of the primary outfall device, and all stages below that will more than meet the critical objective, and will therefore be controlling particles much smaller than the critical size specified in the objective. It may seem that the pond is therefore over-designed and that the pond is larger than needed. However, the 5  $\mu\text{m}$  critical particle size is typically substantially larger than the 90<sup>th</sup> percentile particle size, and the added control provided at the lower stages in the pond is generally needed to provide this level of control on an annual basis. As indicated previously, the 90<sup>th</sup> percentile particle size is typically only 3  $\mu\text{m}$ , or smaller.

To check pond sizing criteria, a sensitivity analysis can be conducted using DETPOND, with varying pond sizes. DETPOND allows easy modifications of the pond surface areas by applying a multiplier to all surface area values. The model can then be re-run for each condition (after modifying the outlet structure to provide the critical flow rate at the pond stages). A typical set of plots is shown as Figure 41a through 41h, for Austin, TX, and Minneapolis, MN (prepared by John Easton, an UAB graduate student as part of a class project). These basic pond designs were based on the design criteria presented earlier and evaluated for several decades of recorded rain events. The ponds were then modified (making them smaller and larger than the basic design) to observe the effect on the overall performance. Figures 41a to 41d indicate the effect of different surface areas on the critical particle size controlled for commercial and residential areas for each of these cities. If the annual average control objective was 5  $\mu\text{m}$  (indicated by the solid line), then the pond can be substantially smaller than if 5  $\mu\text{m}$  was the worst-case control objective. The basic commercial ponds in both cities were sized to be 1.7 surface acres per 100 acres of drainage area (1.7% of the contributing areas), while the medium density residential area basic ponds were sized to be about 0.8 surface acres per 100 acres of drainage area (0.8% of the contributing areas). These plots show that all particles smaller than 5  $\mu\text{m}$  particles would be controlled at these pond sizes in both cities for all rain events. However, the annual average removal rates would be much better for these sized ponds (about 1 to 3  $\mu\text{m}$  for these examples). This results in suspended solids controls of about 90%. The 90<sup>th</sup> percentile particle size (by weight) in stormwater was previously shown to be from about 0.8 to 8  $\mu\text{m}$ , but more typically it is in the narrow range of about 2 or 3  $\mu\text{m}$ . If the average control objective was for 5  $\mu\text{m}$  particles and larger, then the ponds could be substantially smaller, but the suspended solids removals would then be much worse. An average control objective (instead of a worst-case control objective) of 5  $\mu\text{m}$  would likely only provide about 50 to 75% suspended solids control.

Figures 41e to 41h show the number of events per year that would likely enter the secondary spillway (exceeding the storage capacity of the pond, based solely on the “water quality volume” of the pond). A reasonable goal for the use of the secondary spillway would be about twice a year. In these cases, the ponds in Austin exceed the base storage capacity much more frequently than the Minneapolis ponds for under-sized ponds, likely due to the differences in the specific rain characteristics at the two cities.

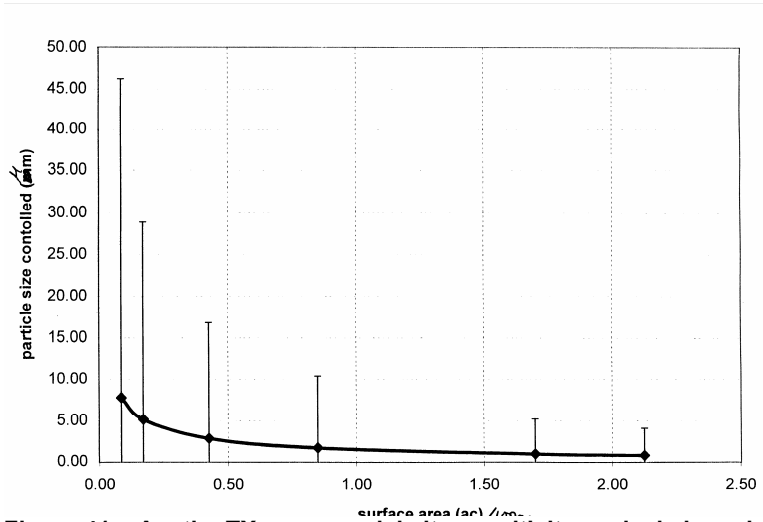

Figure 41a. Austin, TX, commercial site sensitivity analysis based on surface area of pond.

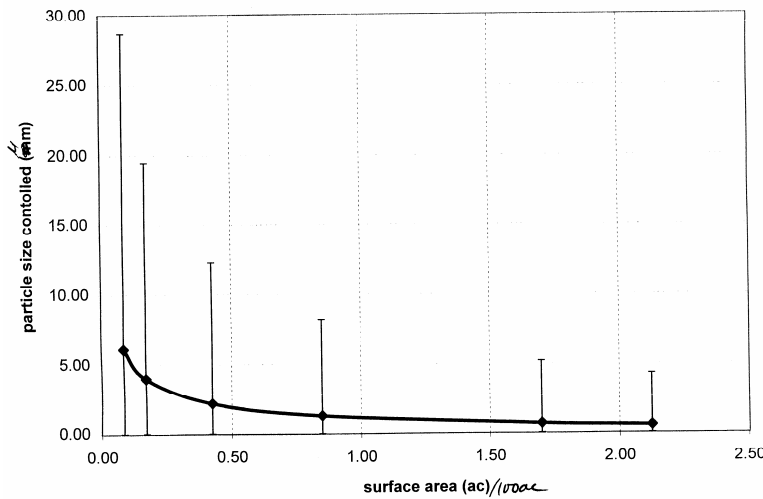

Figure 41b. Minneapolis, MN, commercial area sensitivity analysis based on surface area of pond.

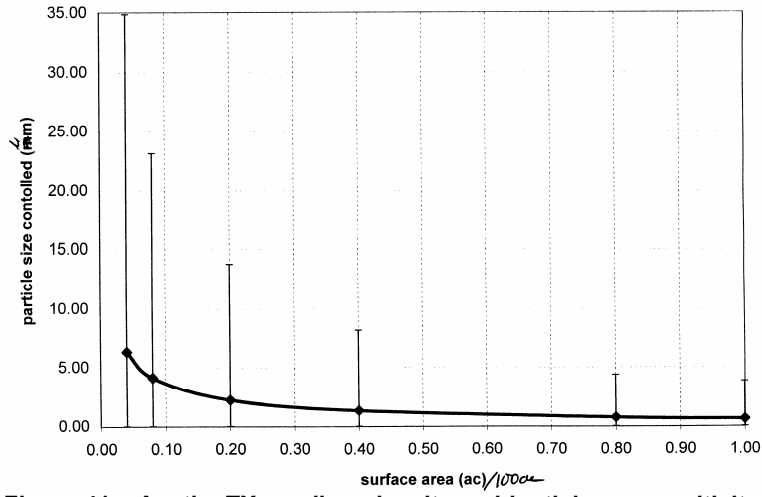

Figure 41c. Austin, TX, medium density residential area sensitivity analysis based on surface area of pond.

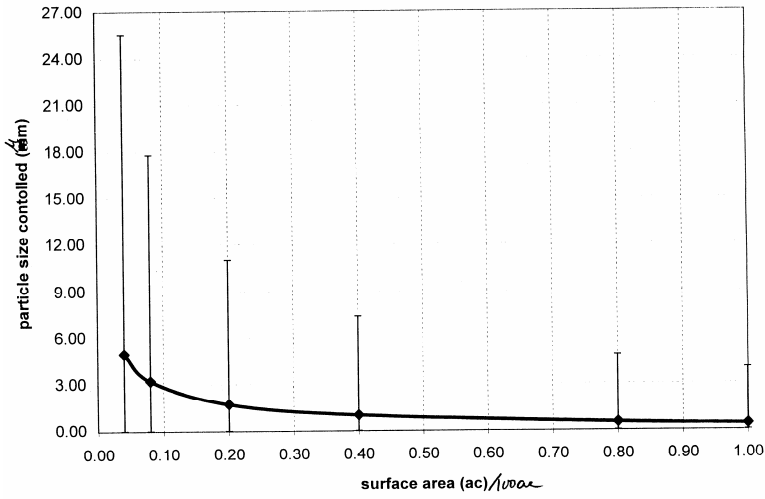

Figure 41d. Minneapolis, MN, medium density residential area sensitivity analysis based on surface area of pond.

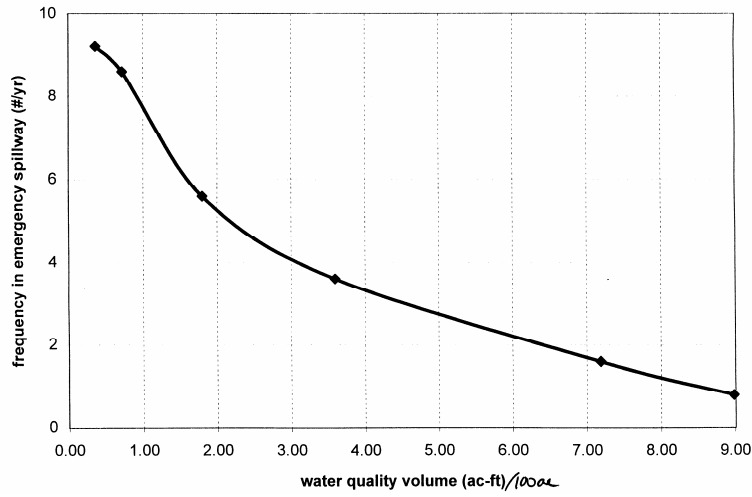

Figure 41e. Austin, TX, commercial area sensitivity analysis indicating number of spillway events per year.

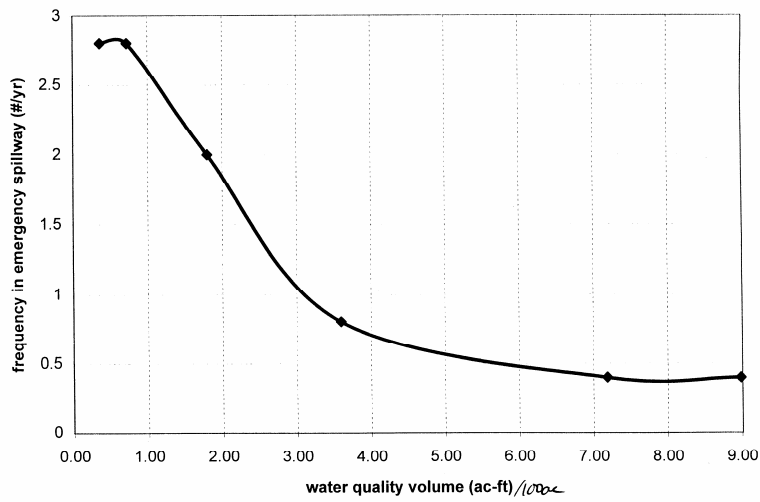
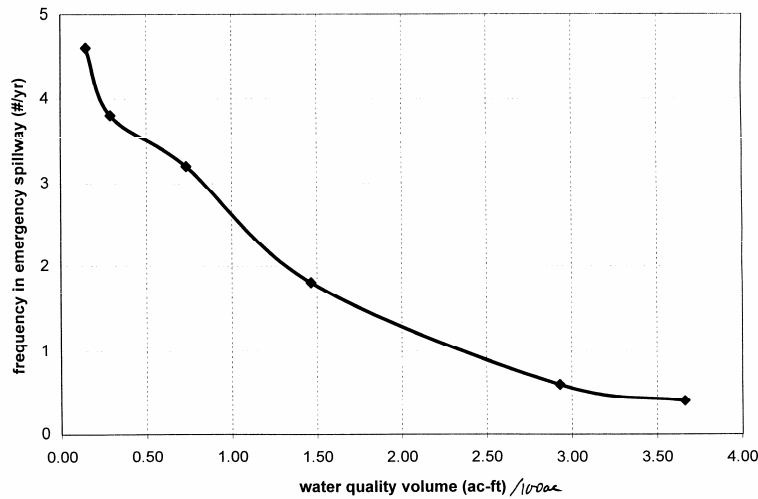
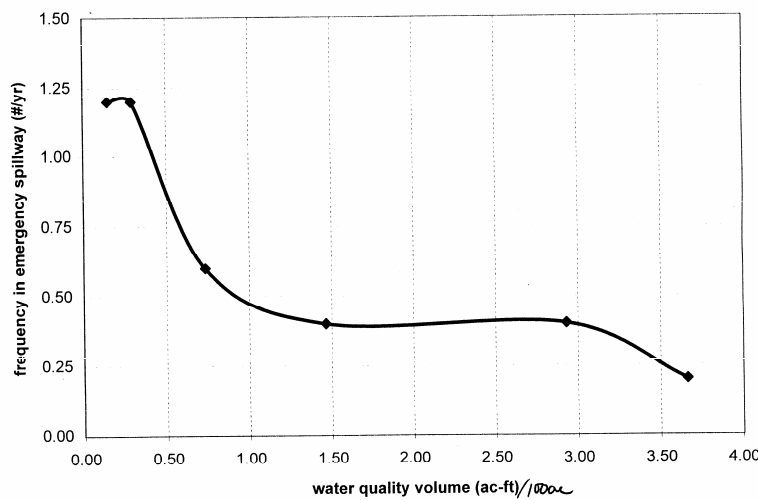

Figure 41f. Minneapolis, MN, commercial area sensitivity analysis indicating number of spillway events per year.



**Figure 41g. Austin, TX, medium density residential area sensitivity analysis indicating number of spillway events per year.**



**Figure 41h. Minneapolis, MN, medium density residential area sensitivity analysis indicating number of spillway events per year.**

### **The Use of the DETPOND Program to Statistically Evaluate Wet Pond Performance**

DETPOND was developed by Bob Pitt and John Voorhees to enable a continuous simulation of wet stormwater detention ponds. This continuous simulation is important to understand the storm to storm variation and long-term performance for typical rain conditions. The basic analysis procedures in DETPOND are similar to the detention pond analysis procedures provided in SLAMM, the Source Loading and Management Model, but offers some additional model output choices to enable more detailed evaluations of individual detention facilities. Appendix A is a user's guide for DETPOND which also includes a simple design example. Additional assistance is provided in the Help components of the model.

DETPOND uses conventional procedures to predict hydraulic conditions (pond storage-indication routing) and the behavior of particulates in stormwater as it passes through a detention pond (surface overflow rates described by the



Hazen equation and quiescent settling using Stoke's and Newton's laws), as described in previous discussions. DETPOND was specifically designed for continuous long-term evaluations, using lengthy rain series. In its current Windows configuration, it is limited only by computer resources (and available time) in the number of rains that it can evaluate. It is also currently quite fast, requiring only a few minutes on most computers to complete a single run using several decades of rainfall data. Whereas most computer-based pond models require time increment direction from the user and frequently crash due to unstable algorithms, DETPOND predicts reasonable calculation increments based on the duration of each rain and interevent period. If the calculation appears to approach unstable conditions, it automatically starts over with a reduced calculation increment. In addition, if the pond design is too small or if the outfall is inadequate, causing catastrophic overflow conditions, the program doesn't crash, but continues using the last known outfall or surface area value, and notes that the pond overflowed. The tabular output of the model can also be easily imported into spreadsheets and graphing programs to produce statistical summaries of the pond performance.

DETPOND can therefore be easily used to evaluate an existing design or pond under a wide variety of rain conditions. It can be used with a single event (most commonly used when observed influent hydrograph data is available) or with a lengthy rain series (when the program predicts runoff and hydrograph characteristics).

***Example Pond Performance Using Suggested Design Specifications and DETPOND***

An evaluation of the performance of a pond was conducted using the above specifications for a wide range of Birmingham, Alabama, rains. This example illustrates how the pond performed for these varying conditions. The following list shows the pond dimensions used:

- 100 acre medium density residential area watershed
- 0.8 acre (35,850) pond (0.8 percent of 100 acres to result in a 5 µm, or 95 percent control of suspended solids).
- 5 feet wet pond depth during dry weather (to minimize scour and to provide sacrificial storage for sediments between pond dredging). This results in a storage volume of about 175,000 cubic feet below the invert.
- 0.5 inch of runoff freeboard storage, corresponding to 1.25 inch of rain.
- pond surface area and stage relationship, above the normal pond elevation:

stage (ft)	surface area (ft <sup>2</sup> )
0	35,850
0.8	50,600
1.6	65,340
2.4	81,680
3.2	98,010

- 90° V-notch weir from 0 to 3.2 feet of stage (above normal wet pond depth), and a 20 foot long emergency spillway from 1.6 to 3.2 feet of stage.

DETPOND was used to investigate the performance of this pond for many local rains. Analyses showed that the pond stage barely reached the emergency spillway and the hydraulic effects of the pond were not significant for a typical Birmingham design storm (4.1 inch rain). The peak runoff flow rate for this event was not changed, and the assumed triangular inlet hydrograph shape changed very little (Figure 42). However, the pond had significant suspended solids reductions (Figure 43), even for this moderately large rain. The flow-weighted average performance of the pond was better than 90 percent removal of suspended solids, and the worst performance, occurring at peak flow rates, was only reduced to about 85 percent. The pond could have been designed to also provide appreciable peak runoff flow rate reductions, but that was not desired due to the lack of a basin-wide hydraulic analysis. Peak flow rate reductions in detention ponds are only obtained through extending the period of flow. If not carefully done, this extended flow period can easily increase downstream peak flow rates to greater values than if no detention was used.

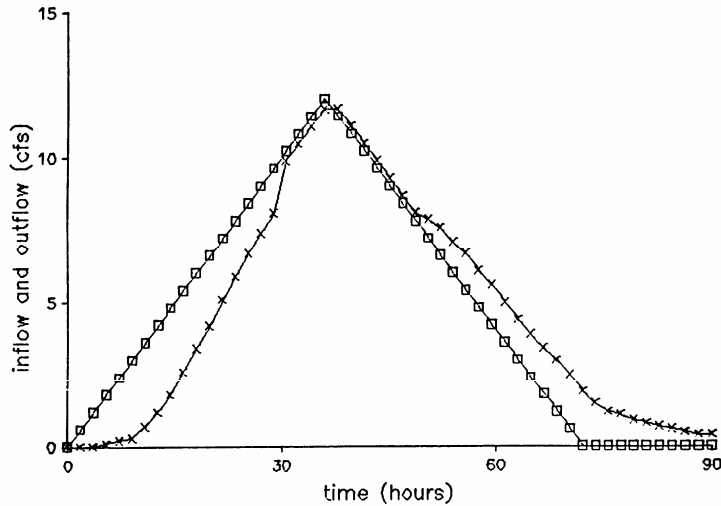

**Figure 42. Modeled detention pond outflow hydrograph for 4.1 inch, 24-hour rain example.**

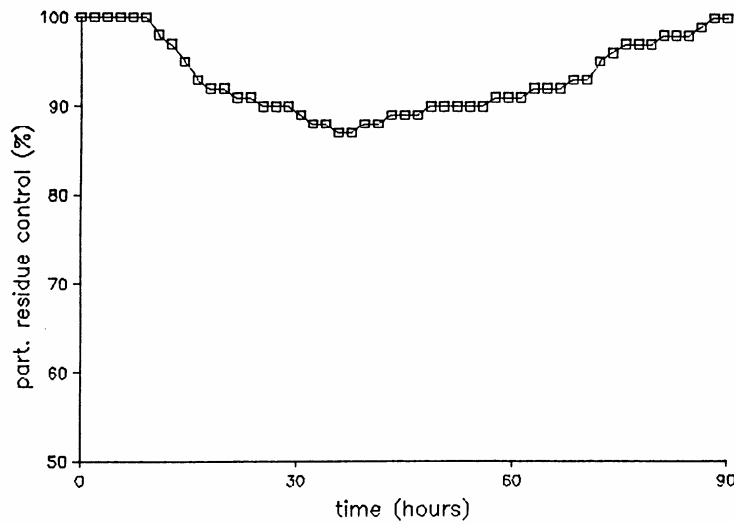
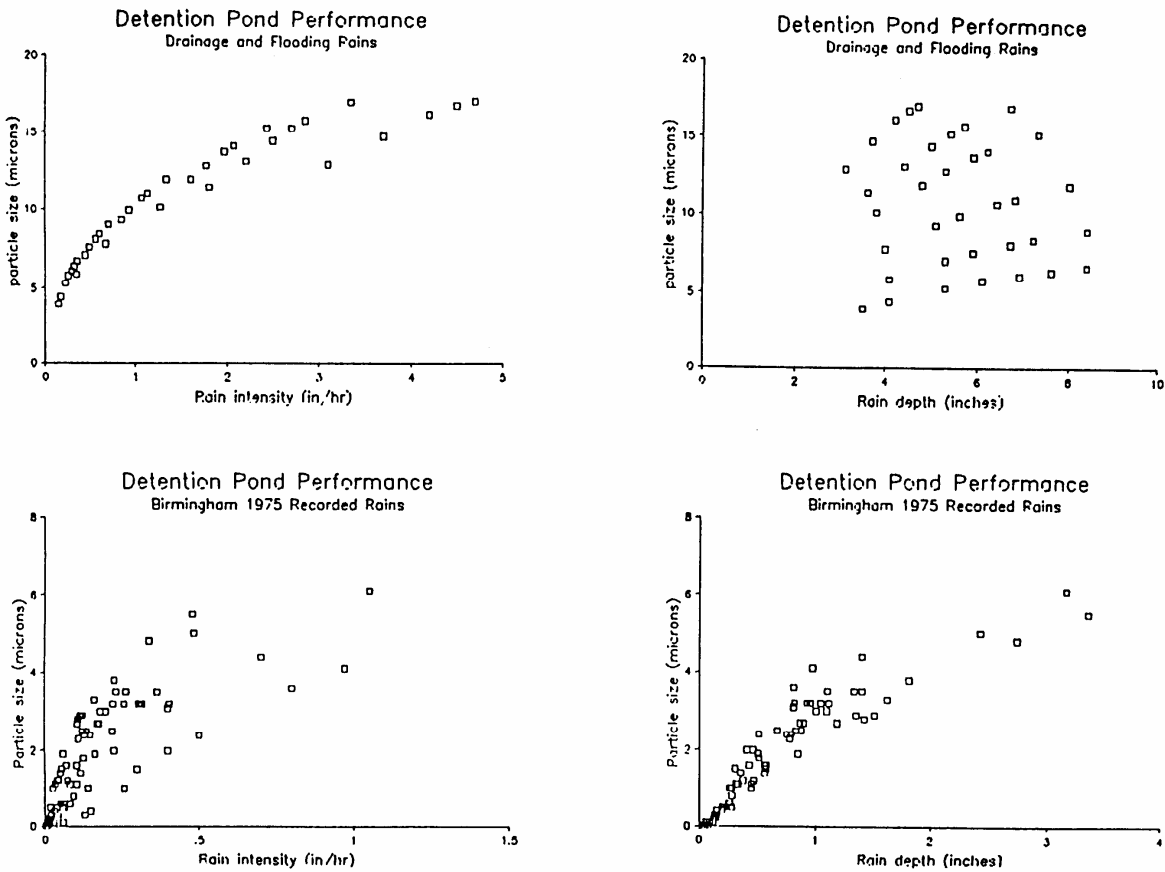

**Figure 43. Modeled detention pond suspended solids removal performance for 4.1 inch, 24-hour rain example.**

Pond performance was also modeled for many typical rain conditions (the 112 rains occurring during the 1975 Birmingham rain year) and for all major storms having 1 to 100-year frequencies and 1 to 24 hour durations. The pond achieved suspended solids reductions of greater than 86 percent for all typical events and achieved greater than 65 percent removals of suspended solids, even for the extremely intense 1 hour, 100-year event. Many of the drainage and flooding design storms had suspended solids removal rates of greater than 80 percent.

Figure 44 shows that the particle size control levels were closely related to rain intensity for the large storms, but were better related to rain depth for the typical rains. The typical rains all had similar rain intensities, narrowing the data scatter. Only two of the 112 storms in the 1975 rain year failed the 5  $\mu$ m design criterion, and only by small amounts. The smaller rains all have much better removals than the 5  $\mu$ m criterion. The median performance of the pond was greater than 95 percent control of suspended solids. Even for the extreme events, the detention pond should provide greater than a 65 percent control of suspended solids. Analyzing the extreme drainage and flooding

rains is needed to check the adequacy of the emergency spillway. As noted, the initial designs for spillway capacity can be made using the procedures given in TR55 (SCS 1986).



**Figure 44. DETPOND modeled particle size removals by standard pond for various rain depths and intensities.**

Figure 45 contains plots of the flushing ratios for the different rains. The flushing ratio is the ratio of the storm runoff volume to the pond storage volume below the lowest invert. A low flushing ratio indicates that much of the effluent from the pond is from the preceding dry period, while a high flushing ratio indicates that the pond may have been “blown out” during the event. Rain depth is the best indicator of flushing. Rains of about 1.5 inch in depth had runoff volumes about equal to the dry period storage volume. It is important to know the flushing ratio for a pond that is being monitored in order to understand the mixture of waters captured at the pond discharge. Consistently having low flushing ratios during most storms may indicate an over-sized pond, with unnecessary warming of the pond waters.

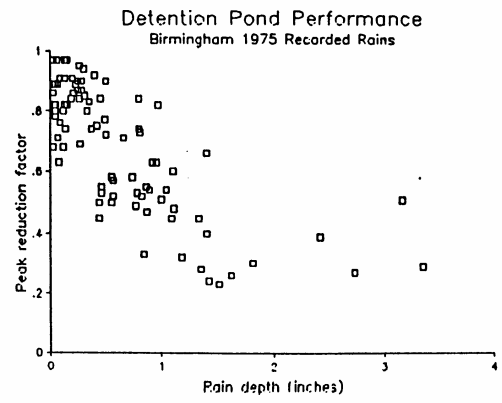
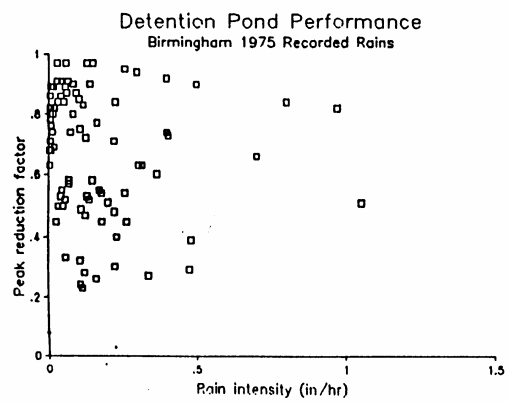
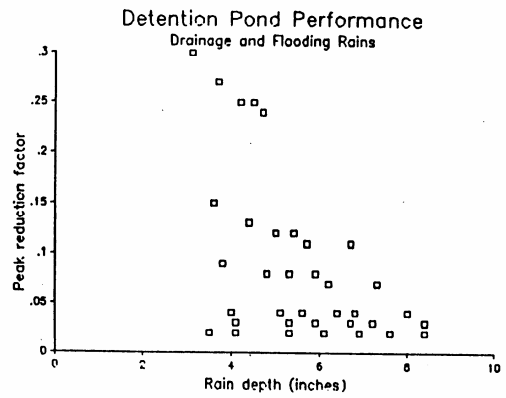
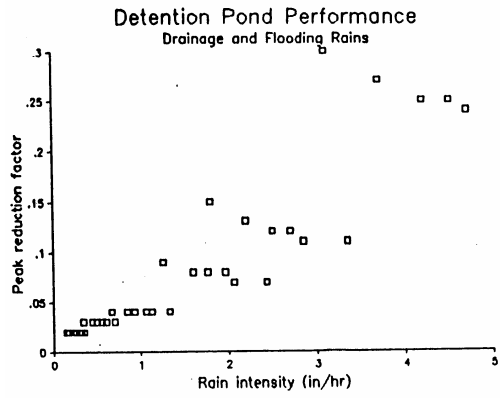

Wet Detention Ponds R. Pitt May 20, 1997 page 104

**Figure 45. DETPOND modeled peak reduction factors by standard pond for various rain depths and intensities.**

Figure 46 illustrates the relationships of maximum pond stage with rain. Like particle control, rain intensity was most important for larger rains, but rain depth was the better indicator of maximum stage attained during typical rains.

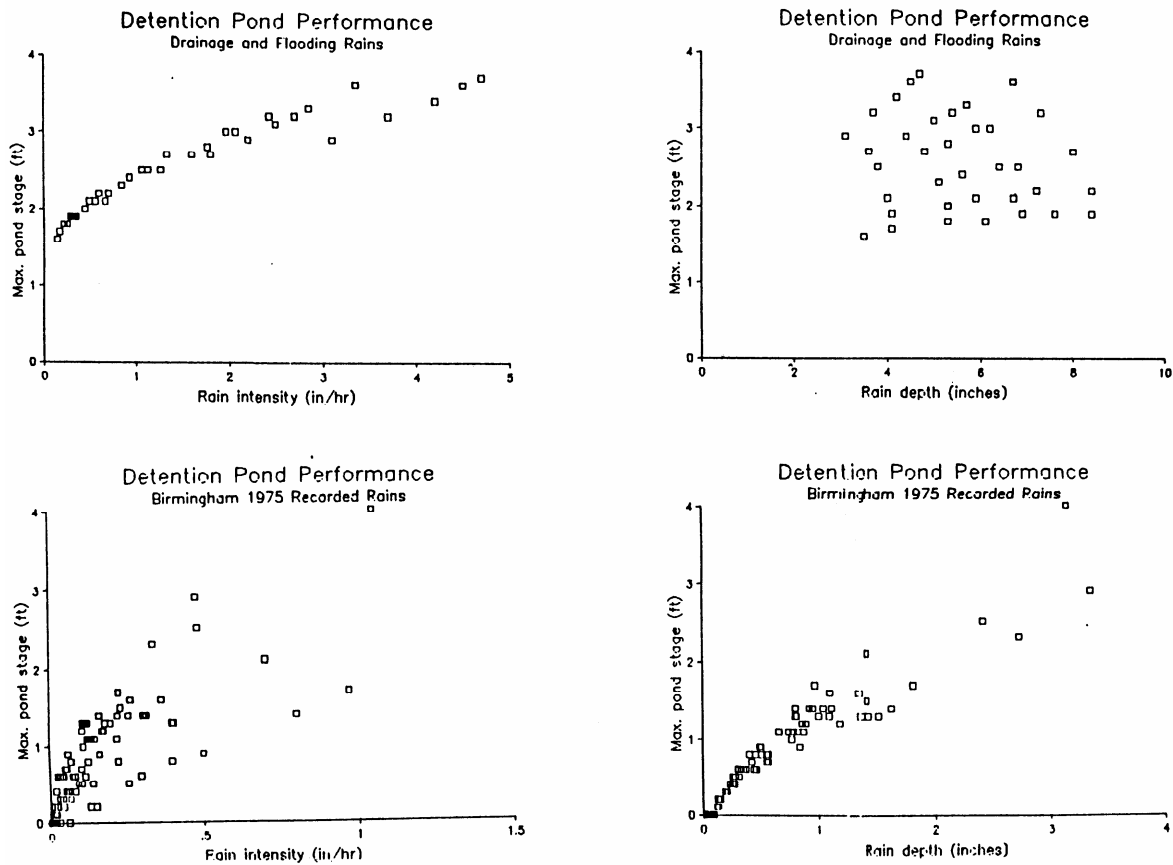

**Figure 46. DETPOND modeled maximum stage of standard pond for various rain depths and intensities.**

Figure 47 shows plots of the peak reduction factors (PRF) for the pond. Peak reduction factor is a measure of the peak flow rate reduction, comparing the effluent to influent peak flow rates. A PRF value of 0.5 indicates a 50 percent flow rate reduction, while a PRF of 0.9 indicates a 90 percent reduction in flow rates. PRF values are usually of most concern during major storms. These values were quite low during these events. The most intense rains only achieved PRF values of about 0.3. Water quality ponds should have minimal effects on flow rate, unless actual flow rate reduction objectives are available, based on basin-wide hydraulic analyses.

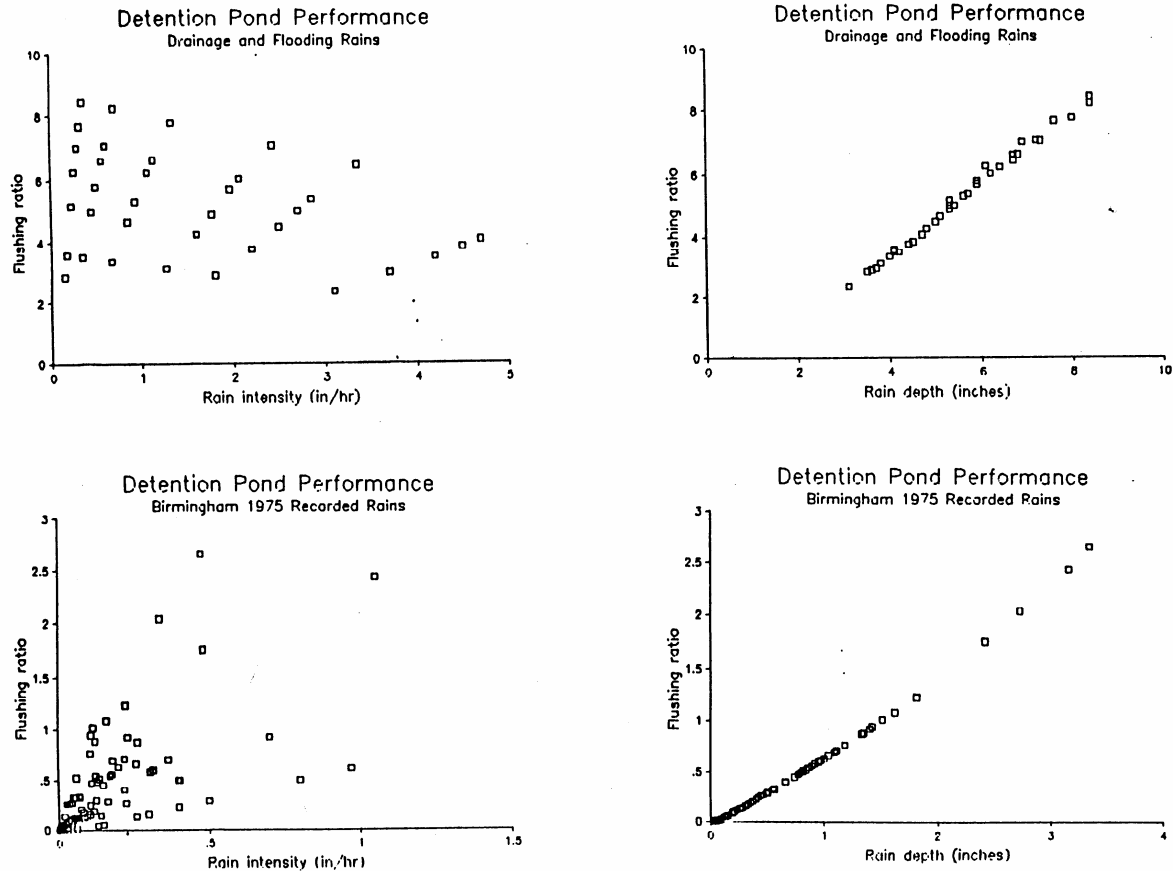

Figure 47. DETPOND modeled flushing ratios of standard pond for various rain depths and intensities.

### DETPOND Verification using Data Collected at the Monroe St. Detention Pond, Madison, WI

The USGS and the Wisconsin Department of Natural Resources have been monitoring the Monroe St. wet detention pond in Madison for a number of years. Particle size distributions of influent (including bedload) and effluent have been monitored for about 50 storms. The actual particle size distributions and suspended solids removals have been compared to calculated pond performance, using DETPOND.

The original pond was creating severe downstream erosion in the channels between the pond and the receiving water, and the pond storage volume was not effectively being used for either flood control or water quality benefits. The outlets were modified and the pond has undergone extensive monitoring to confirm the water quality benefits of the retrofit.

The US Geological Survey (USGS), in cooperation with the Wisconsin Department of Natural Resources (WDNR) investigated the Monroe St. wet detention pond located in Madison, WI (House, *et al.* 1993). The University of Wisconsin Arboretum originally constructed the pond to protect the water quality and ecology of Lake Wingra and surrounding wetlands from stormwater. Figure 48 shows the location of the pond and the watershed. The pond is located on the downstream side of Monroe street at the outlet of a storm sewer that drains a 0.96-square km (237 acre) urbanized area. Land use in the watershed area consists mostly of single-family residences and commercial strip development, with some institutional uses (schools and churches). The average basin slope is 2.2 percent.

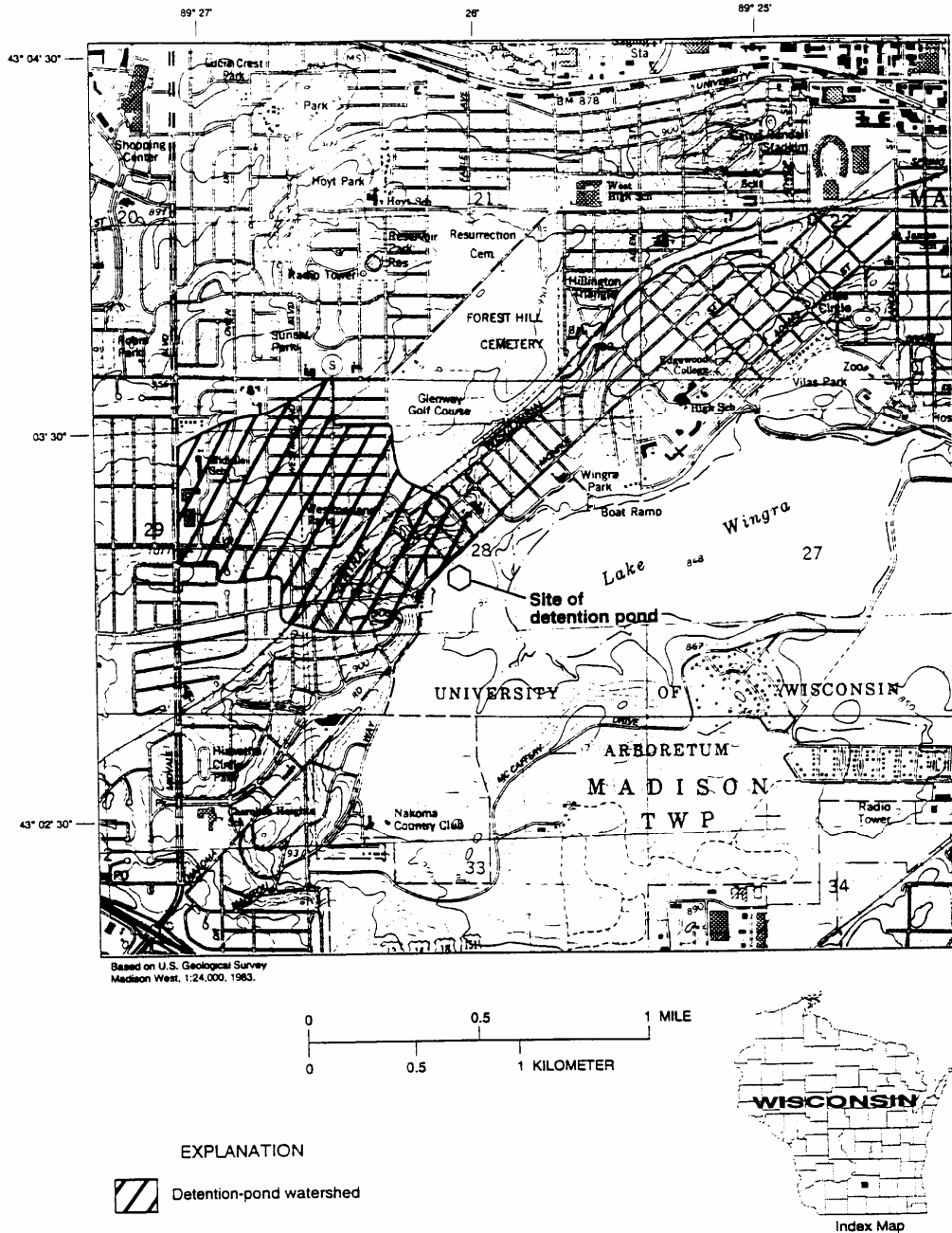

**Figure 48. Monroe St. watershed area, Madison, WI.**

The Monroe Street pond has a surface area of 5,670 m<sup>2</sup> (1.42 Acre), a maximum depth of 2.3 m (7.5 ft) and an average depth of 1.1 m (3.6 ft) at normal pool elevation. The shape of the pond is basically round to oval with a small island. The inlet side is nearest to Monroe Street and the two outlets are on the far side away from Monroe Street. Figure 49 shown the bottom contours of the pond. The pond has a surcharge storage volume above the normal pool elevation that is capable of holding the 10-year, 24-hour storm-runoff volume without overtopping the containment berm around the pond. Figure 50 is the pond stage-surface area curve. The pond has two outlets, each controlled by 90-degree V-notch weirs that drain to channels leading to Lake Wingra. The weirs are located in 8 ft. diameter concrete vaults, with 30 in. concrete pipes leading to the pond. The outlets in the pond are therefore

submerged. Figure 51 is the pond composite outlet discharge curve. The bottom of the pond consists of a clay layer that inhibits infiltration of water from or into the pond.

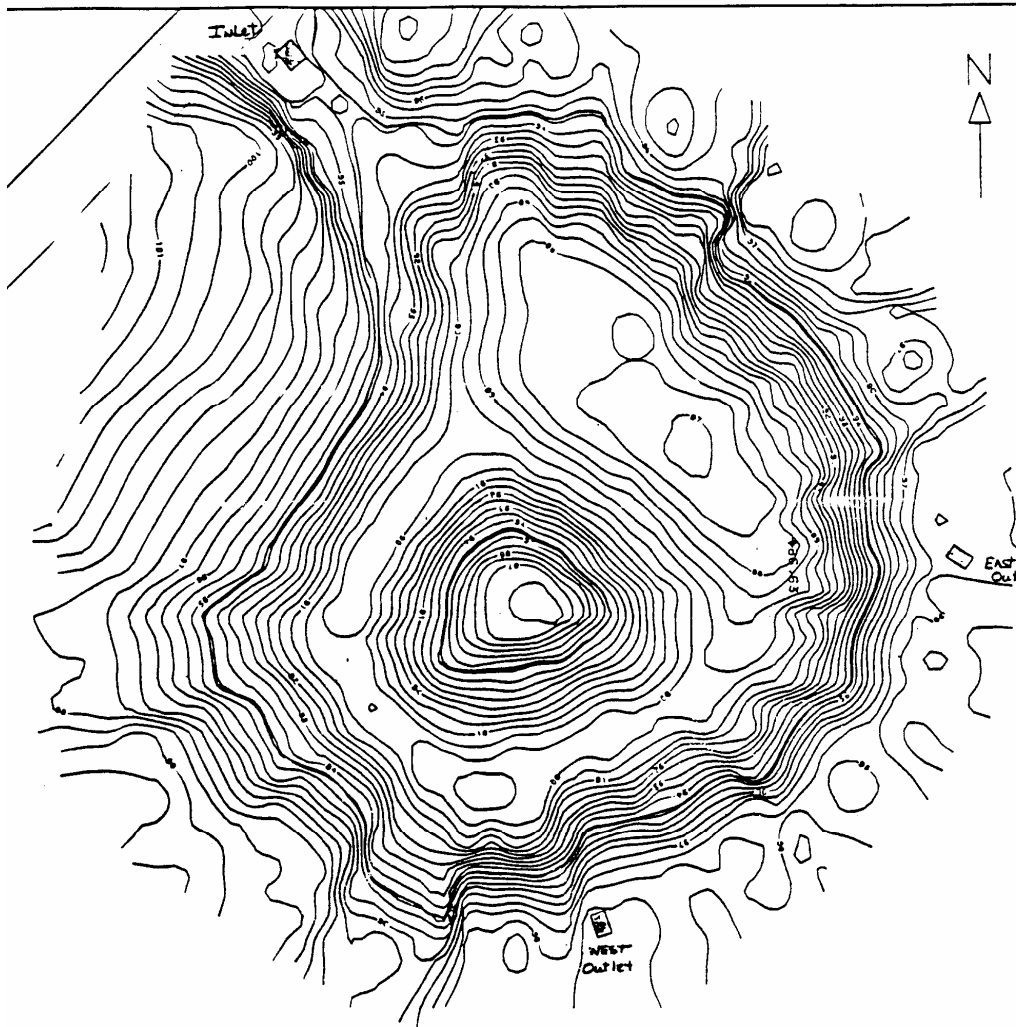

Figure 49. Monroe St. pond contour map.



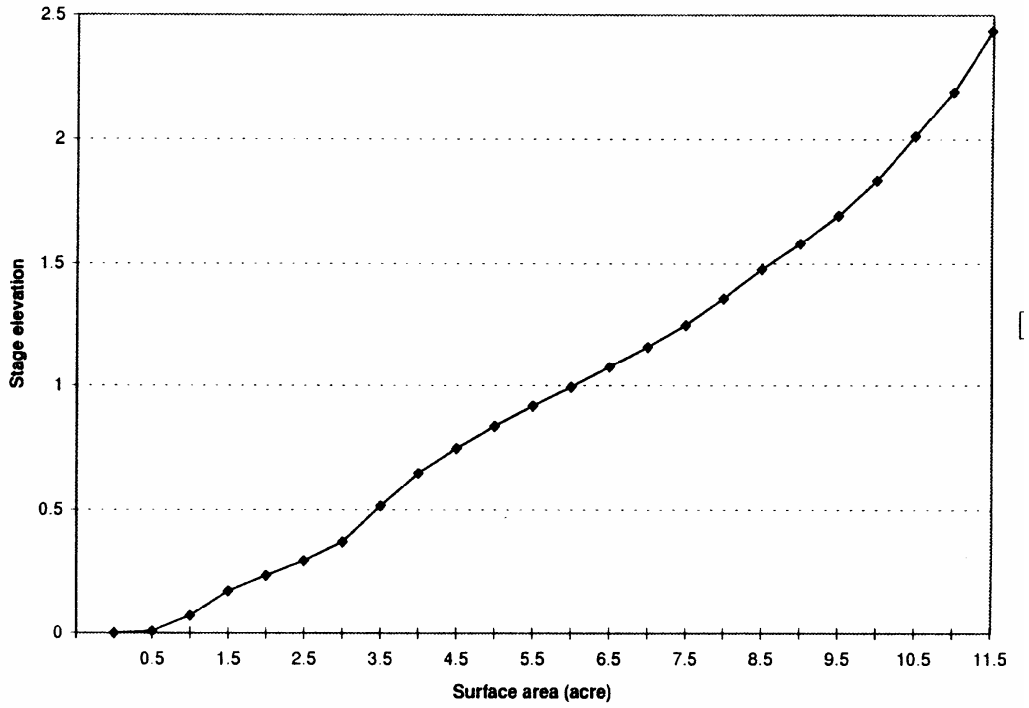

Figure 50. Pond-surface area curve for Monroe St. pond.

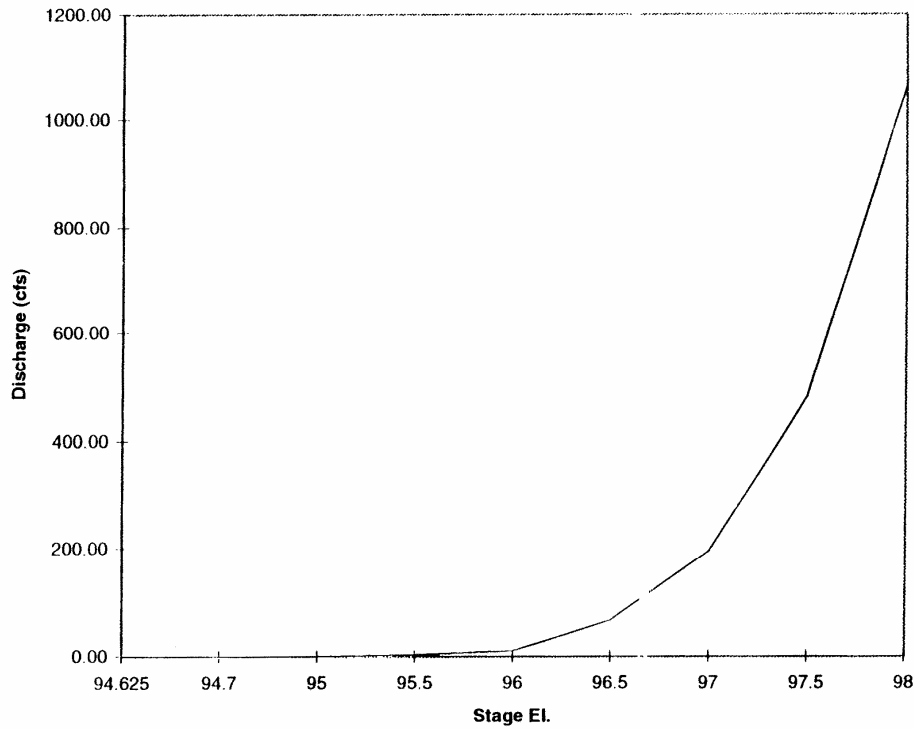

Figure 51. Stage-discharge curve for Monroe St. pond.

The initial primary outlet configuration consisted of two 8 ft. long rectangular weirs located in the vaults, made with concrete block walls. The original flow capacity of these two weirs was enormous, being about 50 cfs at 1 ft. head and 250 cfs at 3 ft. head. As noted above, the discharges from the pond were little attenuated from the inflow velocities and severe channel erosion was occurring in the wetlands, negating the sediment trapping benefits of the pond. There was also no evidence that the emergency spillway was ever used since construction, even with several massive storms. In fact, the pond elevation barely fluctuated.

The outlets were therefore modified to reduce the downstream erosion problems by removing several courses of concrete blocks and installing 90-degree V-notch weirs made of plate steel in each vault. The pond normal water level was dropped about 6 inches with a lowered invert. The new primary outlets have total flow capacities of about 5 cfs at 1 ft. head and 80 cfs at 3 ft. head. The pond surface fluctuates more now, and the emergency spillway has been active every few years. Most significantly, the downstream channels are now stable.

The pond was designed for an expected 90% event mean concentration (EMC) removal for suspended solids (particulate residue). The ratio of pond to drainage area is 0.6 percent. This percentage is close to the value (0.4% to 0.8%) required for 5  $\mu\text{m}$  control for the land uses in the watershed, which generally corresponds to a 90 percent reduction of suspended solids.

A total of 64 events were extensively monitored between February 1987 and April 1988. The monitored rains varied from 2 to more than 82 mm during this period. Periodic water quality and flow monitoring has also continued at this pond since 1988.

### ***Method of Investigation***

Water-quality data were collected by the U.S. Geological Survey (House, *et al.* 1993) using programmable automatic water samplers (refrigerated), installed at the inflow and outflow sites of the pond. The outflow data was collected at two locations, east and west. The samplers were programmed to obtain flow-proportional samples for each storm. These samples represent the flow-averaged constituent concentrations during a runoff event. These samples were removed from the samplers, preserved, and shipped to the Denver USGS laboratory for analysis within 24 hours of being collected. The samples were analyzed for suspended solids, volatile total solids, total and dissolved chemical oxygen demand (COD), total chloride, total and dissolved phosphorus, phosphate total and dissolved forms of total Kjeldahl nitrogen (TKN), nitrates, and total and dissolved forms of copper, zinc, and lead. Most of the copper and lead data were too low for the analytical method used and are not reported here.

Precipitation data were also recorded at 5-minute intervals during the storm events using a recording rain gage located at the pond site. Storm runoff (pond inflow) was monitored at the box culvert that was the terminus of the 0.96-km<sup>2</sup> drainage area. Discharge rates and flow volumes passing through the culvert were determined by use of a flow velocity sensor and water level indicator installed inside the culvert. The velocity and depth sensors were connected to a data logger that recorded the water level and velocity data and computed discharge rates based on the culvert geometry.

### ***Data Analysis and Observations***

The pond inlet and outlet pollutant concentrations were analyzed to determine the pollutant reduction within the pond. Statistical analyses were used to investigate various relationship between inlet and outlet concentrations. Statistical analysis were also used to describe particulate pollutant strengths and percent controls. Each statistical process are described in the following paragraphs. The basic data are contained in the USGS report. (House, *et al.* 1993).

### ***Hydrograph/Flow Calibration***

An important part of the Monroe St. project was validating the DETPOND wet detention pond water quality model that was used to design the retrofit of the outlet structures (Pitt and Voorhees 1995). The first step in the validation was to check flow volumes and peak flow rates, and the complete hydrographs.

Fifteen storm events were used to validate the flow portions of the DETPOND program. The program predicted outflow flow values from the inflow hydrographs using the storage-indication routing method. The outfall

predictions (at 5 minute intervals) were compared to the observed outfall flow values. The predicted outflow hydrographs very closely matched the corresponding observed outflow hydrographs. In addition to comparing the general shape of the discharge hydrographs, the outflow total discharge volume, peak discharge flow rate, suspended solids removal, and outflow particle size distribution were also compared for validation. The predicted outflow volumes and peak discharges also very closely matched the observed outflow conditions. These comparisons are summarized on Figure 52 which compare the predicted and observed outflow volumes and the outflow peak flow rates. Figure 53 contains 12 of the actual outflow hydrographs, illustrating the close fits between the observed and modeled flows for highly different rain conditions.

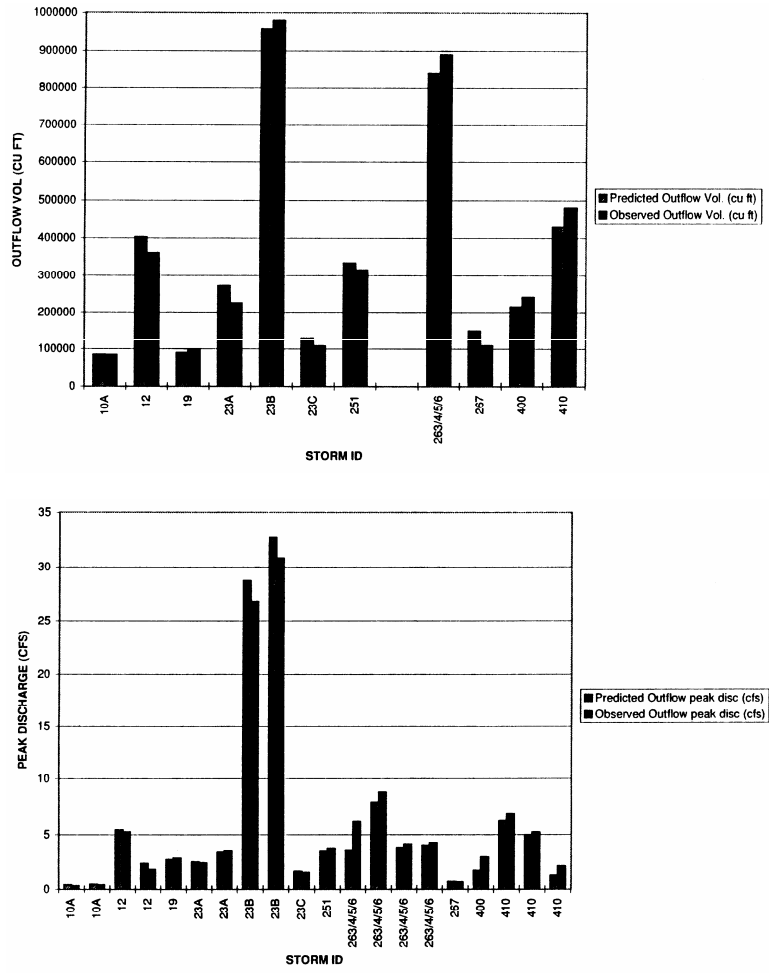

Figure 52. Predicted and observed flow volumes and peak flow rates.

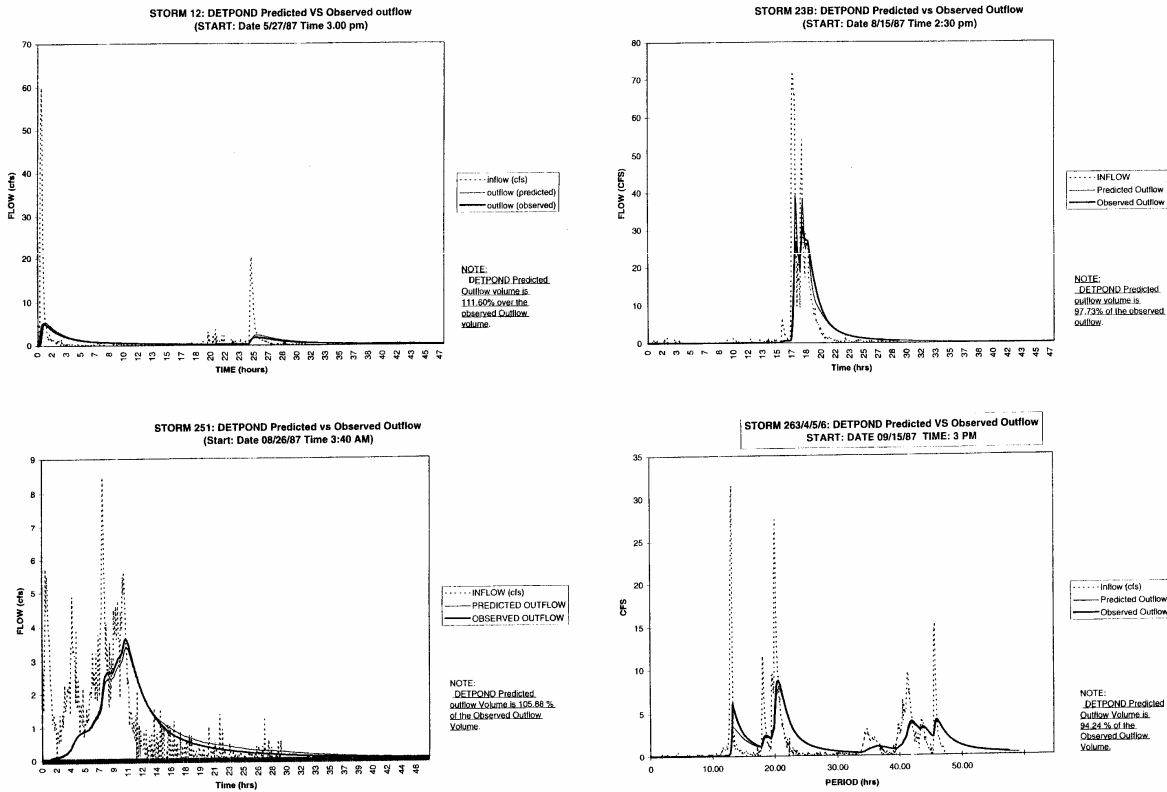

Figure 53. Predicted and observed hydrographs.

**Observed Influent and Effluent Pollutant Concentrations.** Table 19 lists the influent and effluent conditions observed at the pond. The number of observations, and the mean, maximum, and average concentrations are shown. The standard deviation and coefficient of variation, plus the Mann Whitney  $\alpha$  values (indicating if the influent and effluent values are statistically significantly different) are also summarized.

**Table 19. Summary of Observed Influent and Effluent Pollutant Concentrations at Monroe St. Pond**

The coefficient of variation (COV) is calculated by dividing the standard deviation by the mean. COV basically normalizes the standard deviation. A high value indicates that the data spread is wide, requiring many data observations to obtain a precise estimate of the event mean concentration (EMC). Conversely, a small COV value indicates that most of the data fall close to the mean and the sampling requirements are smaller for the same confidence. COV varied from 3.58 for inlet chlorides to 0.06 for outlet filtered lead. Chlorides tend to have a wide concentration variation, likely due to seasonal variations. Filtered lead COV values are low, as shown on the steep probability plots, indicating very little concentrations variations for all samples.

The Mann-Whitney test is a non-parametric analysis comparing two sets of data. The null hypothesis used in the Mann-Whitney is inlet pollutant concentration minus outlet pollutant concentration equals zero. Generally, an  $\alpha$  value  $< 0.05$  indicates that the sample sets are from two different populations (significantly different at the 95%

confidence level). The following constituents had significant  $\alpha$  values indicating that the concentrations were significantly affected by the pond:

- Total solids
- Suspended solids
- Volatile solids
- Chlorides
- COD (all forms)
- Phosphorus (all forms)
- Phosphate
- TKN (total and particulate)
- Nitrate
- Copper (filtered)
- Zinc (all forms)

Probability plot of pond inlet and outlet pollutant concentrations are shown on Figure 54. Each constituent was found to be linearly distributed when plotted on log-normal plots. In most cases (except for TDS, chlorides, and filtered zinc), the inlet data values are plotted at higher values than the outlet data, indicating pollutant reductions in the pond.

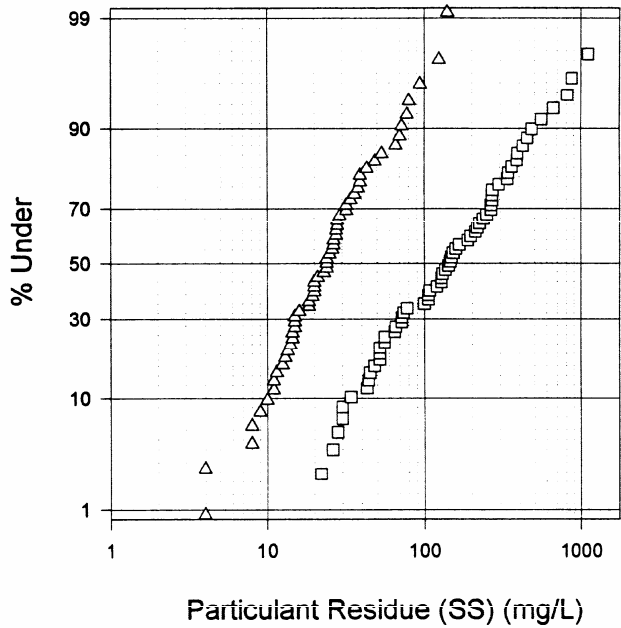

- Inlet
- △ Outlet

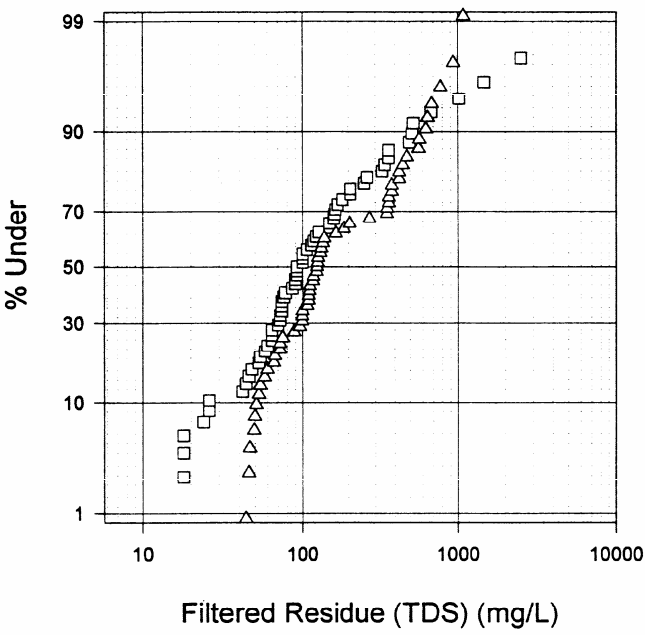

- Inlet
- △ Outlet

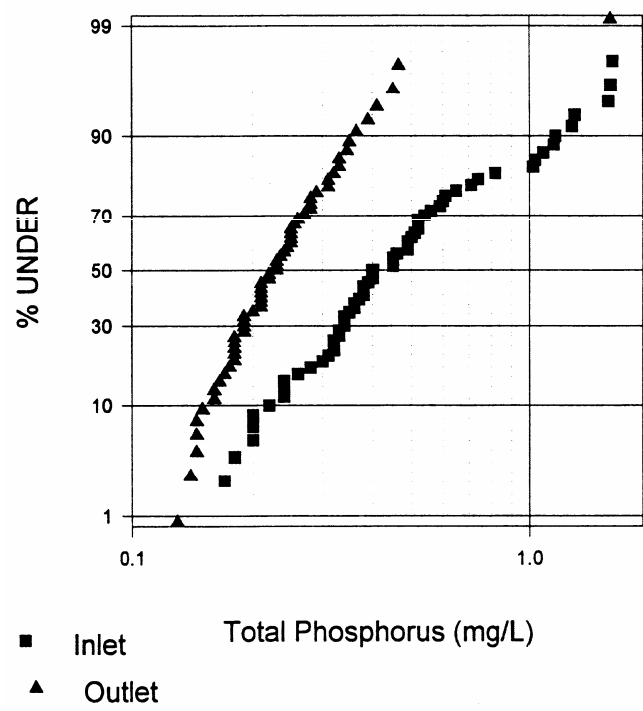
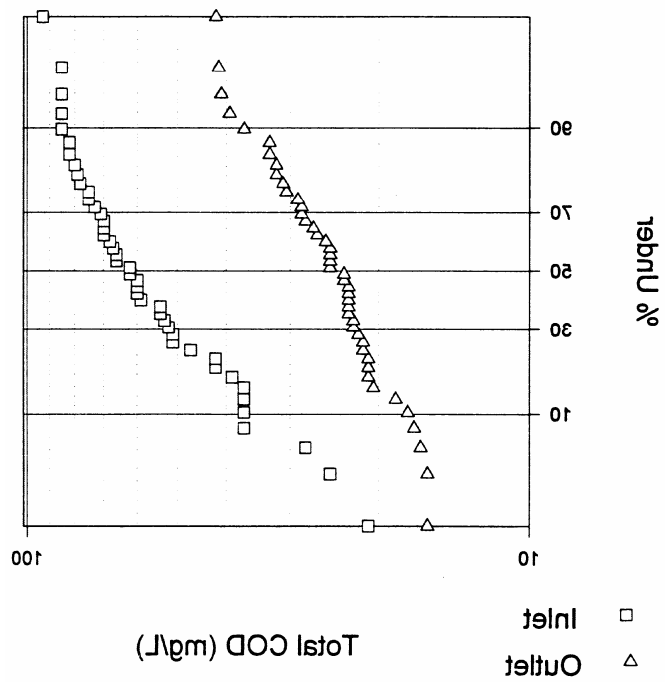

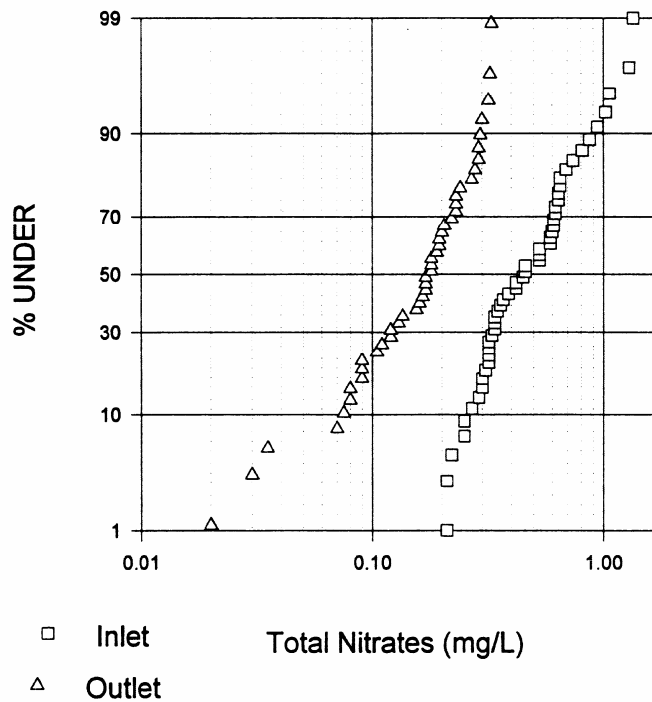

**Figure 54. Probability plots of influent and effluent pollutant concentrations.**

**Particulate Pollutant Strength.** Particulate pollutant strength (PPS) is the ratio of a particulate pollutant concentration to the suspended solid concentration, expressed in mg/kg. PPS was calculated for each pollutant with a particulate form and plotted on a probability versus strength chart (Figure 55). All pollutants had higher outlet than inlet PPS values due to preferential removals of large particles in the detention pond, leaving relatively more small particles in the discharge water. The small particles in stormwater have greater PPS values than the large particles. Wide differences indicates that the predominant components of the contaminant (such as for TKN and phosphorus) are associated with the fines that are not removed in the pond.



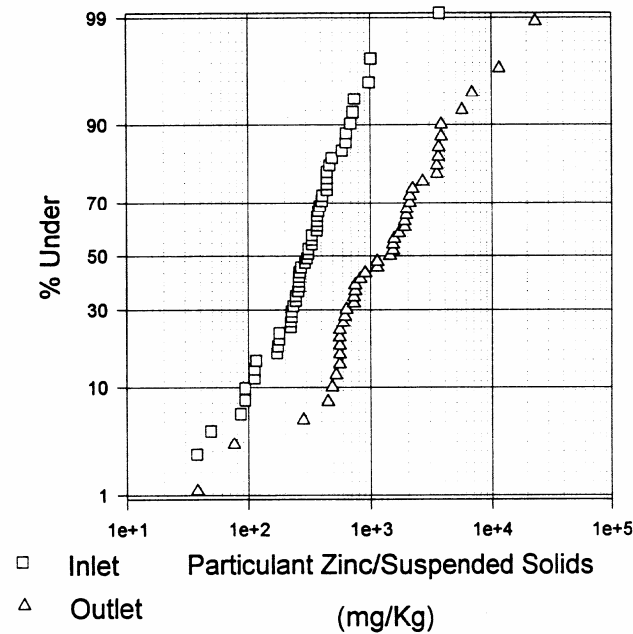
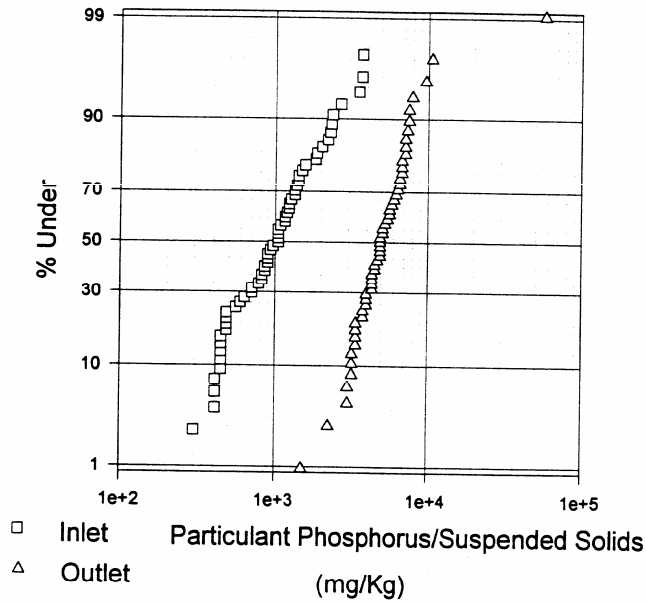

Figure 55. Particulate pollutant strengths.

**Control of Pollutants.** The reduction of pollutants was calculated from the difference in pollutant concentrations in the inlet and outlet water for each event, as shown on Table 20. As expected, control was higher for all particulate forms of the constituents than for filtered forms. Filtered constituents (<0.45  $\mu\text{m}$ ) behave as very small particles and will tend to be transported through the wet detention pond relatively unchanged.

**Table 20. Summary Table of Pollutant Control\***

	10%	50%	90%
Suspended solids	35	87	97
Total Residue	<0	52	86
Volatile Residue	<0	41	76
Filtered Residue	<0	<0	56
Particulate COD	15	80	95
Total COD	29	60	84
Filtered COD	<0	24	80
Particulate Phosphorus	-20	60	80
Total Phosphorus	<0	47	81
Filtered Phosphorus	<0	43	83
Particulate TKN	-40	40	80
Total TKN	<0	45	75
Filtered TKN	<0	12	68
Particulate Zinc	- 117	70	95
Total Zinc	<0	31	69
Filtered Zinc	<0	<0	59

\*Copper and Lead observations were mostly below the detection limits and are therefore not shown.

### ***Particle Size Distributions and Short-Circuiting***

Seven events were studied to find the short-circuiting “n” factors using observed and predicted particle size distributions in effluent water. Particle size distributions were measured using the Sedigraph method at the USGS Denver laboratory. This technique measures settling rates of different size suspended solid particulates down to 2 µm. The value of n is calculated using the concentrations of large particles that are found in the effluent. In ideal settling, no particles greater than the theoretical critical size (about 5 µm for Monroe St.) should appear in the effluent. However, there is always a small number of these larger particles. It is generally assumed that short-circuiting is responsible for these large particles. The measured values for n were one, or less, indicating a high degree of short-circuiting in the pond. However, these observations were possibly affected by scour of bottom deposits near the subsurface effluent pipes. The maximum effect of short-circuiting on pond performance is shown in the following table, showing the average reduction in suspended solids removals for different n values, compared to the best performance (n value equal to 8):

n value	% SS removal (average)	reduction in % SS removal compared to n=8
8	85	
3	84	1
1	80.7	4.3
0.5	78.5	6.5
0.2	59	26

The calculated values of n (based on matching measured effluent particle size distributions with distributions calculated using different values of n) ranged from about 0.2 to 1, indicating “very poor performance”, or worse. The median value of n observed was about 0.35, indicating a degradation in annual average suspended solids capture efficiency of no more than about 10 percent. The effects of this short-circuiting, even with the extremely low values of n for Monroe St., only has a minimal effect on the suspended solids percentage removals. The Monroe St. pond provided an average suspended solids reduction of 87%, compared to the design goal of 90%. These values are quite close and the short-circuiting has a negligible effect on actual performance, as the pond surface is relatively large (0.6% of the drainage area) and the outlets were efficiently modified during the retrofitting activities.

Although the pond is producing very good suspended solids removals as designed, the particle size distributions of the effluent indicate some short circuiting (some large particles are escaping from the pond). The short circuiting has not significantly reduced the effectiveness of the pond (measured as the percentage of suspended solids captured). Therefore, care should be taken in locating and shaping ponds to minimize short circuiting problems, but not at the expense of other more important factors (especially size, or constructing the pond at all). Poor pond shapes probably cause greater problems by producing stagnant areas where severe aesthetic and nuisance problems originate.

Figure 56 shows the particle size distribution for the inflow events, including bedload. The median size is about 8  $\mu\text{m}$ , but it ranges from about 2 to 30  $\mu\text{m}$ . About 10% of the particles may be larger than 400  $\mu\text{m}$ . The largest particle size observed was larger than 2 mm. The bedload added about 10% of the mass of these particulates and was associated with the largest sizes. The settling velocities of discrete particles can be predicted using Stoke's and Newton's settling equations. Probably more than 90% of all stormwater particulates (by volume and mass) are in the 1 to 100  $\mu\text{m}$  range, corresponding to Laminar flow conditions. In most cases, stormwater particulates have specific gravities in the range of 1.5 to 2.5 (determined by conducting settling column, sieving, and microscopic evaluations of the samples, in addition to particle counting), corresponding to a relatively narrow range of settling rates for a specific particle size.

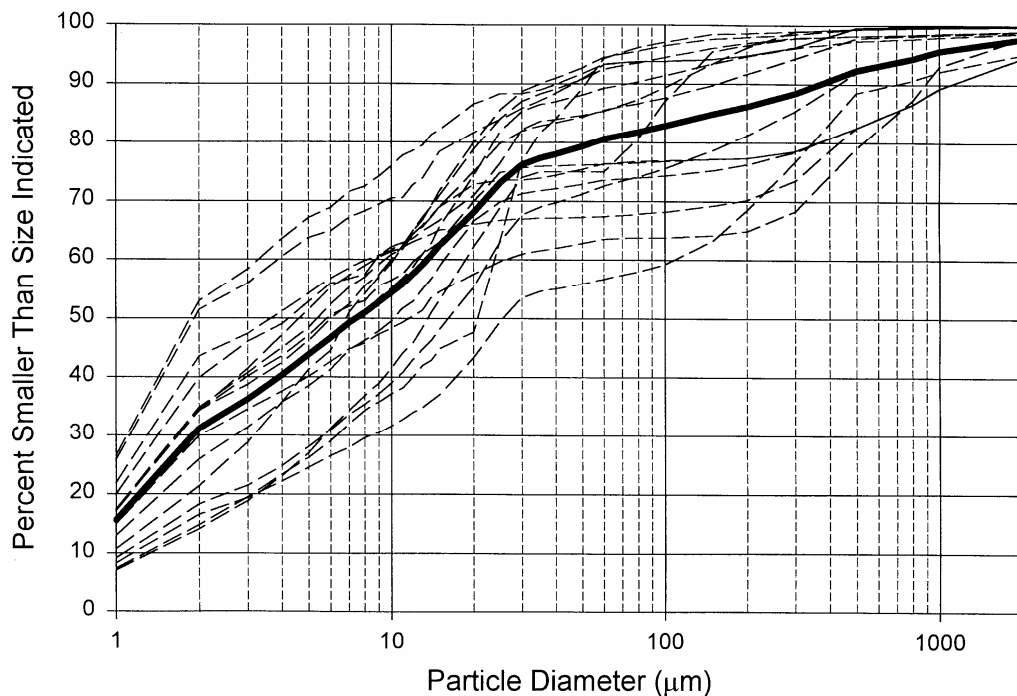

**Figure 56. Inlet particle size distributions observed at the Monroe St. wet detention pond.**

### ***Monroe St. Pond Verification Conclusions***

DETPOND successfully predicted the hydraulic, water quality, and particle size control at the Monroe St. detention pond in Madison, WI. In addition, DETPOND was successfully used to modify the outlet structure at the pond to enhance the pond's performance. The retro-fitting of the Monroe St. wet detention pond was very successful. Changing the outlet structures from large rectangular weirs to v-notch weirs significantly reduced effluent flows and reduced downstream channel erosion. The modification also improved the water quality benefits of the pond.

All constituents had outflow concentrations lower than associated inlet concentrations, except for chlorides, TDS, and filtered zinc. Suspended solids had a median removal of 87%, the median particulate COD removal was 60%,

the median removal for total forms of the nutrients (TKN and phosphorus) were 40 to 45% and the median removal for total zinc was 30%. (The median particulate zinc removal was 70%). A well designed wet detention pond will remove 70 to 90% of suspended solids, 70% of COD, 60 to 70% of nutrients and 60 to 95% of the particulate forms of the heavy metals. The measured short-circuiting factor indicated a severe short-circuiting problem, but that could be a false indication due to minor scour near the effluent works in the pond. The Monroe Street pond is meeting all reasonable expectations in both downstream channel protection and in contaminant capture.

### **Verification Based on Measured Performance at a Landfill Pond in Birmingham, AL.**

Another verification of the design criteria and the DETPOND model is available from the MSCE thesis prepared by Robert Creel (*Evaluating Detention Pond Performance with Computer Modeling Verification*, Dept. of Civil and Environmental Engineering, University of Alabama at Birmingham, AL. 1994, 137 pgs). Figure 56b shows the complete 41.3 ha drainage area and the pond. The drainage area has 20.3 ha of bare disturbed soil (the active landfill site), 4 ha of paved highways, and 13.3 ha of mature hardwood forests. The pond requires up to 2 ha for operation when completely full. Figure 56c is a schematic of the pond, showing the small isolated pre-settling pond (0.1 ha) at the upper end of the pond (about 1 ha), the locations of the major drainages entering the pond, and the polishing sand filter (140 m<sup>2</sup>). The numbers on the schematic indicate the sampling locations used during this study. Figure 56d indicates the area and volumes of the pond for different pond surface elevations. Six storms were monitored between Nov 28, 1990 and January 10, 1991, having the following rain depths: 25, 16, 9, 20, 11, and 13 mm. Table 20b contains the particle size distributions of the influent to the pond for the six monitored events. Almost all of the monitored particles (using a Spectrex ILI 1000 laser particle counter and checked with a microscope) were in the range of 15 to 45  $\mu\text{m}$ . Numerous turbidity measurements were made throughout the monitored events at the four sampling locations. Figure 56e is an example of the typical changes of turbidity during the first storm event. The turbidity of water leaving the small pond was very similar to the sheetflow water entering the small pond (several hundred to several thousand NTU), while the turbidity of the water leaving the large pond was greatly reduced (to between 20 and 50 NTU), which was further reduced by the sand filter (to about 1 to 10 NTU).



Figure 56b. Birmingham landfill and pond watershed map.

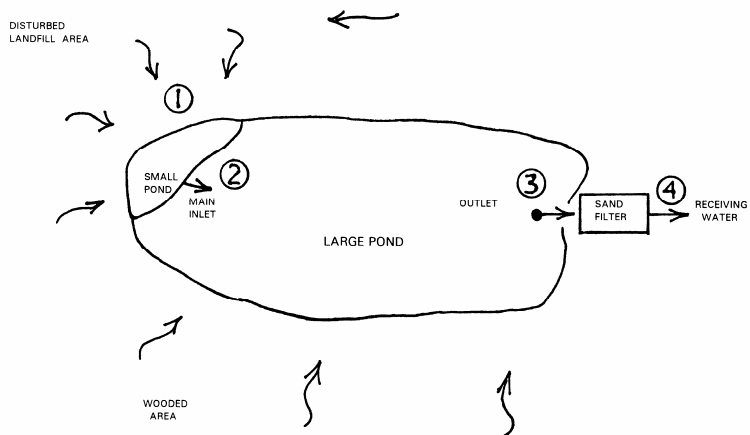

Figure 56c. Birmingham landfill pond schematic.

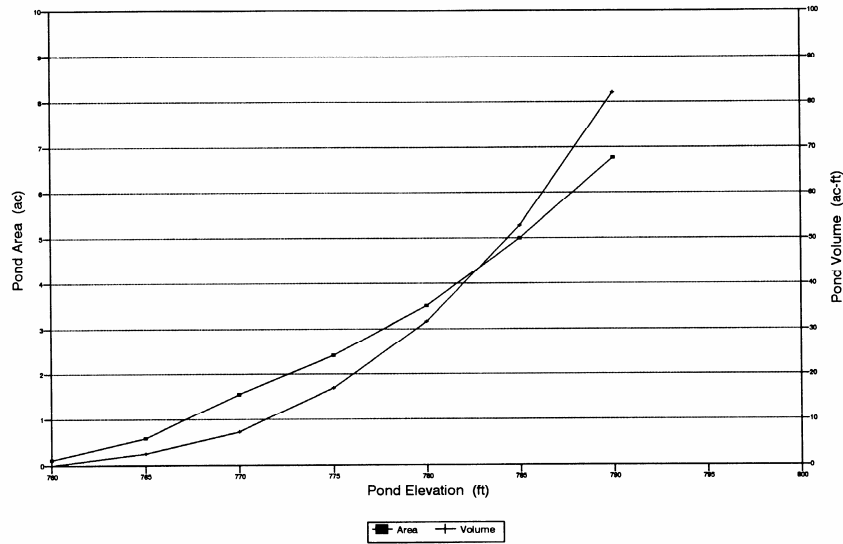
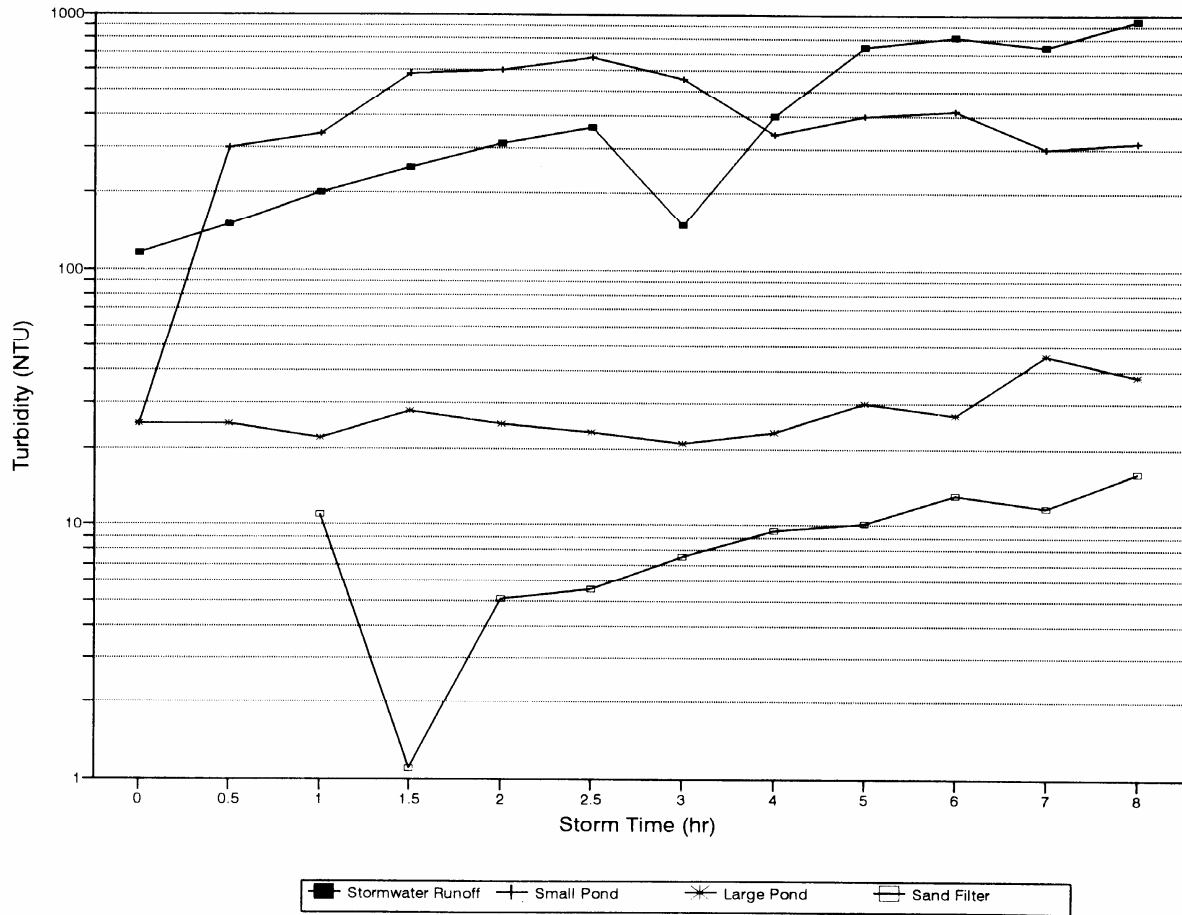

Figure 56d. Birmingham landfill elevation-area and elevation-volumes curves.

Table 20b. Observed Runoff Particle Sizes in Influent Water at Birmingham Landfill (percentage associated with each particle size range, by mass)

Particle Size ( $\mu\text{m}$ )	Storm #					
	1	2	3	4	5	6
<5	0	0	0	0	0	0
5-15	0.1	1.3	1.6	3.6	3.8	2.2
15-15	5.9	5.0	4.4	21.2	26.2	0.8
25-35	24.6	31.1	64.8	75.2	70.0	86.0
35-45	69.4	62.6	29.2	0	0	11.0
45-55	0	0	0	0	0	0
>55	0	0	0	0	0	0



**Figure 56e. Turbidity changes with time for influent, initial small pond, pond, and sand filter effluent for storm #1.**

This was a relatively large pond for the drainage area. The landfill was operating under a NPDES permit which restricted the turbidity of the effluent to 50 NTU. The pond was therefore designed and constructed larger than thought necessary in order to better meet this discharge limit. Since the sand filter clogged quickly and required manual cleaning, it was only used when necessary to ensure the effluent turbidity was less than the discharge limit. Figure 56f shows the successful predictions of the pond hydraulic performance using DETPOND, compared to the observed pond stages during the monitored storms over a wide range of conditions. Table 20c shows the predicted suspended solids removal by the pond, using DETPOND and the monitored particle size distributions and rain conditions, compared to the monitored suspended solids removal. Since the pond was over-sized for the site conditions, it was predicted (and shown to have) almost complete removal of the suspended solids.

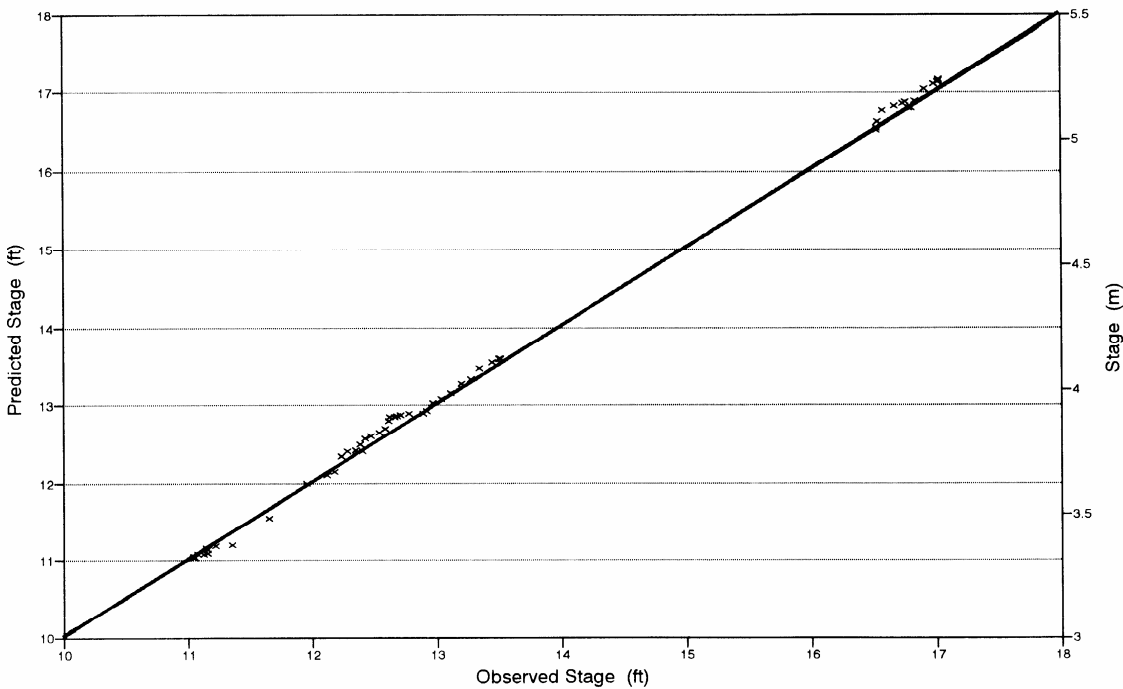

**Figure 56f. Observed and predicted pond stages for Birmingham landfill pond study.**

**Table 20c. Predicted and Observed Suspended Solids Removal for Birmingham Landfill Pond**

	Storm #					
	1	2	3	4	5	6
Predicted Removal, % (using DETPOND)	100	100	100	100	100	100
Observed Removal, %	100	100	99	100	99	100

### Issues Associated with Using a Continuous Record of Rains vs. a Single Event Storm

Single-event designs for hydraulic devices have been used for many decades with reasonably good success. They were developed to evaluate single parameter conditions (especially peak flow rate or maximum stage in drainage design). They are used with the assumption that if the hydraulic structure is designed to withstand this critical event, all events less critical would be safely handled. The critical single event for drainage design is selected from a local intensity-duration-frequency (IDF) curve for the drainage area time of concentration. The level of service is selected based on the return frequency of the design event (such as a “10-year” storm) and the intensity for the design storm is selected based on this level of service and an event duration equal to the watershed time of concentration. This is an effective approach for the design of relatively simple hydraulic structures and was developed due to the impracticality of evaluating a large series of events during a time of manual calculations.

The current availability of inexpensive computer facilities and software has largely negated the need to use a single-event for design (James and Robinson 1982). A much more suitable approach is to use continuous models for an extended period of time. This is especially critical when non-linear processes interact in unpredictable ways for different conditions and when more than simple single-parameter evaluations are needed. Wet weather flow water quality evaluations are much more complex than drainage design evaluations and require continuous simulations for the best results. Specifically, continuous evaluations enable calculations of probabilities of certain levels of performance being exceeded, such as the percentage of flow treated to a certain level.



This is not to say that single-event design storms should not be used for preliminary designs. Sizing of a wet detention pond (or other control practice) for water quality improvement can usually be made using relatively simple guidelines, based on historical performance data, local land use information, and rainfall statistics. However, it is possible and sometimes necessary to evaluate this design with a model under continuous and long-term conditions. This evaluation will produce much more useful information and will enable the “preliminary” design to be modified to more effectively meet the project objectives. In most cases, this long-term simulation only requires several minutes of time to conduct.

### ***Stream Habitat Benefits Associated with Peak Flow Reduction Criteria***

Some of the most serious effects of urban runoff are on the aquatic habitat of the receiving waters. A significant indirect benefit of flow controls for stormwater management is the reduction in associated stream power. Increased flows are probably the best known example of impacts associated with urbanization. Most of the recognition has of course focused on increased flooding and associated damages. This has led to numerous attempts to control peak flows from new urban areas through the use of regulations that limit post development peak flows to pre development levels for relatively large design storms. The typical response has been to use dry detention ponds. In addition to the serious issue of flooding, high flows also cause detrimental ecological problems in receiving waters. The following discussion presents several case studies where increased flows were found to have serious effects on stream habitat conditions, along with recommended approaches for their control.

The aquatic organism differences in urbanized and control streams found during the Bellevue Urban Runoff Program were probably mostly associated with the increased peak flows associated with urbanization. The increased flows in the urbanized Kelsey Creek resulted in increases in sediment carrying capacity and channel instability of the creek (Pederson 1981; Perkins 1982; Richey, *et al.* 1981; Richey 1982; Scott, *et al.* 1982). Kelsey Creek had much lower flows than the reference Bear Creek during periods between storms. About 30 percent less water was available in Kelsey Creek during the summers. These low flows may also have significantly affected the aquatic habitat and the ability of the urban creek to flush toxic spills or other dry weather pollutants from the creek system (Ebbert, *et al.* 1983; Prych and Ebbert undated). Kelsey Creek had extreme hydrologic responses to storms. Flooding substantially increased in Kelsey Creek during the period of urban development; the peak annual discharges almost doubled in the last 30 years, and the flooding frequency also increased due to urbanization (Ebbert, *et al.* 1983; Prych and Ebbert undated).

Snodgrass, *et al.* (1998) reported that in the Toronto, Ontario, area, flows causing bankfull conditions occur with a return frequency of about 1.5 years. Storms with this frequency are in general equilibrium with resisting forces that tend to stabilize the channel (such as vegetation and tree root mats), with increased flows overcoming these resisting forces causing channel enlargement. Infrequent flows can therefore be highly erosive. With urbanization, the flows that were bankfull flows during historical times now occur much more frequently (about every 0.4 years in Toronto). The channel cross-sectional areas therefore greatly increase to accommodate the increased stream discharges and power associated with the “new” 1.5 year flows that are trying to re-establish equilibrium.

Booth and Jackson (1997) found that the classical goal of detention ponds to maintain predevelopment flows was seriously inadequate because there is no control on the duration of the peak flows. They showed that a duration standard to maintain post development flow durations for all sediment-transporting discharges to predevelopment durations will avoid many receiving water habitat problems associated with stream instability. Without infiltration, the amount of runoff will obviously still increase with urbanization, but the increased water could be discharged from detention facilities at flow rates below the critical threshold causing sediment transport. The identification of the threshold discharge below which sediment transport does not occur, unfortunately, is difficult and very site specific. A presumed threshold discharge of about one-half of the pre-development 2-year flow was recommended for gravel bedded streams. Sand-bedded channels have sediment transport thresholds that are very small, with inevitable bed load transport likely to occur for most levels of urbanization.

MacRae (1997) presented a review of the development of the common zero runoff increase (ZRI) discharge criterion, referring to peak discharges before and after development. MacRae shows how this criterion has not effectively protected the receiving water habitat. He found that stream bed and bank erosion is controlled by the frequency and duration of the mid-depth flows (generally occurring more often than once a year), not the bank-full

condition (approximated by the 2 yr event). During monitoring near Toronto, he found that the duration of the geomorphically significant pre-development mid-bankfull flows increased by a factor of 4.2 times, after 34% of the basin had been urbanized, compared to before development flow conditions. The channel had responded by increasing in cross-sectional area by as much as 3 times in some areas, and was still expanding. Table 21 shows the modeled durations of critical discharges for predevelopment conditions, compared to current and ultimate levels of development with “zero runoff increase” controls in place. At full development and even with full ZRI compliance in this watershed, the hours exceeding the critical mid-bankfull conditions will increase by a factor of 10, with resulting significant effects on channel stability and the physical habitat. MacRae (1997) concluded that an effective criterion to protect stream stability (a major component of habitat protection) must address mid-bankfull events, especially by requiring similar durations and frequencies of stream power (the product of shear stress and flow velocity, not just flow velocity alone) at these depths, compared to satisfactory reference conditions.

**Table 21. Hours of Exceedence of Developed Conditions with Zero Runoff Increase Controls Compared to Predevelopment Conditions (MacRae (1997))**

Recurrence Interval (yrs)	Existing Flowrate (m <sup>3</sup> /s)	Exceedence for Predevelopment Conditions (hrs per 5 yrs)	Exceedence for Existing Development Conditions, with ZRI Controls (hrs per 5 yrs)	Exceedence for Ultimate Development Conditions, with ZRI Controls (hrs per 5 yrs)
1.01 (critical mid-bankfull conditions)	1.24	90	380	900
1.5 (bankfull conditions)	2.1	30	34	120

As seen, single-event criterion are not very effective for habitat protection unless relatively small events are used. Unfortunately, when only considering small events, serious drainage and flooding problems associated with large events may not be adequately mitigated. Therefore, flow criteria should consider at least several return frequency events (such as the recommended mid-bank flow condition, along with the less frequent drainage design storm). In addition, the duration of flows larger than critical sediment transport flows should also be controlled in order to provide protection of habitat. The use of continuous simulation including the more common events along with rarer storms causing flooding and drainage damage, should also be considered.

### ***Untreated Flows Associated with Single-Event Criteria***

Another important problem associated with single-event criteria is that many dry detention ponds built have low-flow channels to allow most of the annual flow to pass through the pond without any retention or opportunity for treatment. Only when the inflow exceeds the critical value does it back up in the pond. Therefore, most of the annual flow passes along a small concrete channel, with no treatment, with only a few events a year being treated at all. In these ponds, little scour of the settled particulates would likely occur because the long time period between flooding in the pond would allow incorporation of most of the settled material into the pond grass liner. If the pond was paved or lined with concrete, such as in some depressed tennis courts that are actually dry ponds, then scour may occur. In Bellevue, WA, where these “multi-use” ponds have been used, ramps lead down into the pond/tennis court to allow street cleaners to remove much of the settled sediment after a large rain, allowing little interruption of recreational use of the facility. In all cases, these pond designs, even though designed and operated to suppress large flows, actually treat very small amounts of the annual stormwater flows, with minimal water quality benefit.

### ***Benefits of Using Continuous, Long-Term Simulations***

Urban receiving water problems are related to many different conditions covering a wide range of rain characteristics. Reviews of numerous urban receiving water studies from throughout the U.S. have identified the following diverse list of receiving water problems that may be caused by stormwater (Pitt 1995a and 1995b):

- Sedimentation damage in stormwater conveyance systems and in receiving waters.
- Nuisance algae growths from nutrient discharges into quiescent waters.
- Inedible fish and undrinkable water caused by toxic pollutant discharges.
- Shifts to less sensitive aquatic organisms caused by contaminated sediments and habitat

destruction.

- Property damage from increased drainage system failures.
- Swimming beach closures from pathogenic microorganisms.
- Water quality violations, especially for bacteria and total recoverable heavy metals.

The first four problem areas are mostly associated with slug (mass) discharges (not instantaneous concentrations or rates), while the last three are mostly associated with instantaneous concentrations and high flow rates.

In order to predict receiving water problems caused by stormwater, accurate flow estimates and pollutant mass discharges must be known. Knowing where the potentially problem pollutants originate in the watershed is also valuable in order to select appropriate stormwater control candidates. Accurate knowledge of runoff volumes during different storms has been shown to be necessary when predicting pollutant discharges.

Most of the annual rain is associated with many small individual events, while most of the runoff volume and pollutant mass discharges are associated with a smaller set of intermediate events. The following discussion illustrates this, based on actual monitored rainfall and runoff distributions for Milwaukee, WI (data from the Milwaukee NURP project, Bannerman, *et al.* 1983), and analyses of long-term rainfall histories and predicted runoff for Minneapolis.

Figure 57 includes cumulative probability density functions (CDFs) of measured rain and runoff distributions for Milwaukee during the 1981 NURP monitored rain year (data from Bannerman, *et al.* 1983). CDFs are used for plotting because they clearly show the ranges of rain depths responsible for most of the runoff. Rains between 0.05 and 5 in. were monitored during this period, with two very large events (greater than 3 inches) occurred during this monitoring period which greatly distort these curves, compared to typical rain years. The following observations are evident:

- The median rain depth was about 0.3 in.
- 66% of all Milwaukee rains are less than 0.5 in. in depth.
- For medium density residential areas, 50% of runoff was associated with rains less than 0.75 in.
- A 100-yr., 24-hr rain of 5.6 in. for Milwaukee could produce about 15% of the typical annual runoff volume, but it only contributes about 0.15% of the average annual runoff volume, when amortized over 100 yrs.
- Similarly, a 25-yr., 24-hr rain of 4.4 in. for Milwaukee could produce about 12.5% of the typical annual runoff volume, but it only contributes about 0.5% of the average annual runoff volume, when amortized over 25 yrs.

Figure 58 shows CDFs of measured Milwaukee pollutant loads associated with different rain depths for a medium density residential area. Suspended solids, COD, lead, and phosphate loads are seen to closely follow the runoff volume CDF shown in Figure 57, as expected. Since load is the product of concentration and runoff volume, some of the high correlation shown between load and rain depth is obviously spurious. However, these overlays illustrate the range of rains associated with the greatest pollutant discharges.

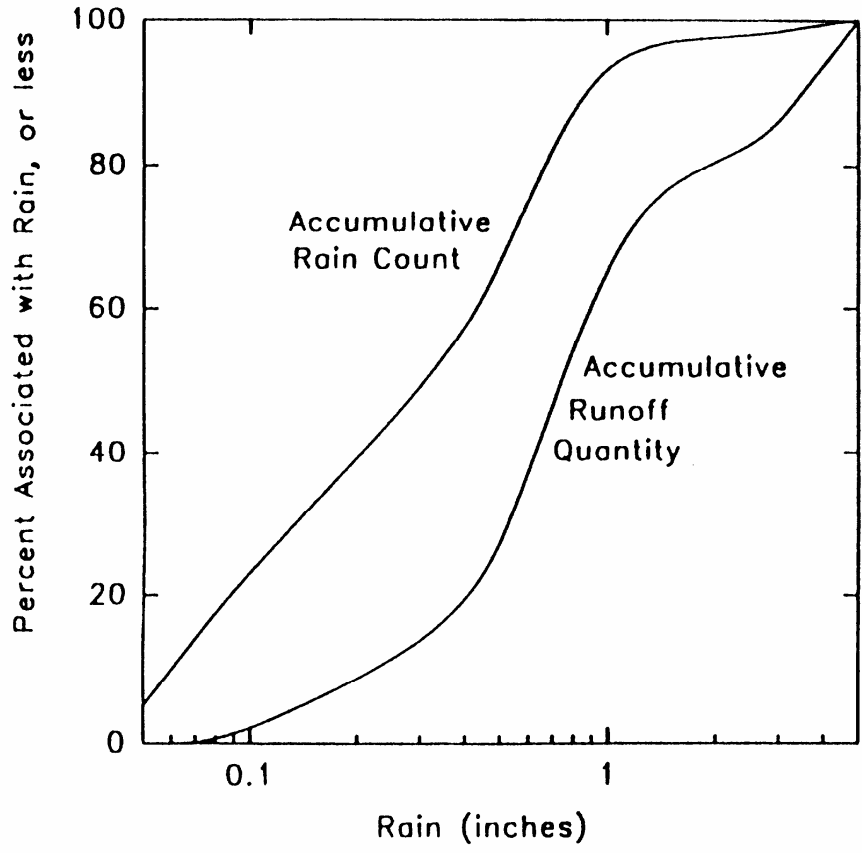

Figure 57. Milwaukee rain and runoff cumulative probability density functions (CDFs).

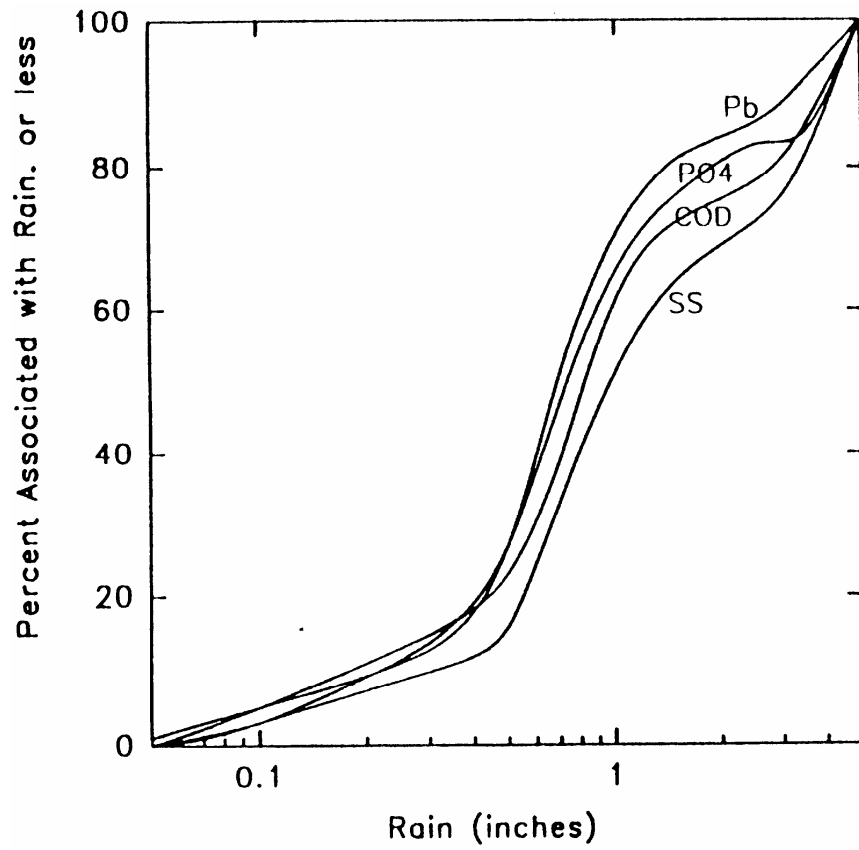

Figure 58. Milwaukee pollutant discharge cumulative probability density functions (CDFs).

The Milwaukee observations show that southeastern Wisconsin rainfall distributions can be divided into the following categories, with possible management approaches relevant for each category of rain:

- Common rains having relatively low pollutant discharges are associated with rains less than about 0.5 in. (12 mm) in depth. These rains account for most of the events, but little of the runoff volume, and are therefore easiest to control. They produce much less pollutant mass discharges and probably have less receiving water effects than other rains. However, the runoff pollutant concentrations likely exceed regulatory standards for several categories of critical pollutants, especially bacteria and some total recoverable metals. They also cause large numbers of overflow events in uncontrolled combined sewers. These rains are very common, occurring once or twice a week (accounting for about 60% of the total rainfall events and about 45% of the total runoff events that occurred), but they only account for about 20% of the annual runoff and pollutant discharges. Rains less than about 0.05 inches generally did not produce noticeable runoff during the field monitoring in Milwaukee, but the lower “cutoff” rainfall would be mostly dependent on the amount of pavement in the drainage. These are key rains when runoff-associated water quality violations, such as for bacteria and total recoverable heavy metals, are of concern. In most areas, runoff from these rains should be totally captured and either re-used for on-site beneficial uses or infiltrated in upland areas. For most areas, the runoff from these rains can be relatively easily removed from the surface drainage system.
- Rains between 0.5 and 1.5 in. (12 and 38 mm) are responsible for about 75% of the runoff pollutant discharges and are key rains when addressing mass pollutant discharges. These rains account for the majority of the runoff volume (about 50% of the annual volume for this Milwaukee example) and produce moderate to high flows. They account for about 35% of the annual rain events, and about 20% of the annual runoff events. These rains occur on the average about every two weeks during the spring to fall seasons and subject the receiving waters to frequent high pollutant loads and moderate to high flows. The small rains in this category can also be removed from the drainage system and the runoff re-used on site for beneficial uses or infiltrated to replenish the lost groundwater infiltration associated with urbanization. The runoff from the larger rains should be treated (such as in wet detention ponds) to prevent pollutant discharges from entering the receiving waters.
- Rains greater than 1.5 in. (38 mm) and less than 3 in. (75 mm) are associated with drainage design and are only responsible for relatively small portions of the annual pollutant discharges. These rains produce the most damaging flows, from a habitat destruction standpoint, and occur every several months (at least once or twice a year) to every few years. These recurring high flows, which were historically associated with much less frequent rains, establish the energy gradient of the stream and cause unstable streambanks. Only about 2 percent of the rains are in this category and they are responsible for about 10 percent of the annual runoff and pollutant discharges. Typical storm drainage design events fall in the upper portion of this category. Extensive pollution control designed for these events would be very costly, especially considering the relatively small portion of the annual runoff associated with the events. However, discharge rate reductions are important to reduce habitat problems in the receiving waters. The infiltration and other treatment controls used to handle the smaller storms in the above categories would have some benefit in reducing pollutant discharges during these larger, rarer storms.
- In addition, extremely large rains >3 inches (>75 mm) also infrequently occur that can exceed the capacity of the drainage system and cause local flooding. This category is infrequently represented in field studies due to the rarity of these large events and the typically short duration of most field observations. The smallest rains in this category are included in design storms used for drainage systems in Milwaukee. These rains occur only rarely (once every several years to once every several decades, or less frequently) and produce extremely large flows. The 3-year monitoring period during the Milwaukee NURP program (1980 through 1983) was unusual in that two of these events occurred. Less than 2 percent of the rains were in this category (typically <<1% would be), and they produced about 15% of the annual runoff quantity and pollutant discharges. During a “normal” period, these rains would only produce a very small fraction of the annual average discharges. However, when they do occur, great property and receiving water damage results. The receiving water damage (mostly associated with habitat destruction, sediment scouring, and the

flushing of organisms great distances downstream and out of the system) can conceivably naturally recover to before-storm conditions within a few years. These storms, while very destructive, are sufficiently rare that the resulting environmental problems do not justify the massive stormwater quality controls that would be necessary. The problem during these events is massive property damage and possible loss of life. These rains typically greatly exceed the capacities of the storm drainage systems, causing extensive flooding. It is critical that these excessive flows be conveyed in “secondary” drainage systems. These secondary systems would normally be graded large depressions between buildings that would direct the water away from the buildings and critical transportation routes and to possible infrequent/temporary detention areas (such as large playing fields or parking lots). Because these events are so rare, institutional memory often fails and development is allowed in areas that may not be indicated on conventional flood maps, but could suffer critical flood damage.

## **Example Use of DETPOND and Wet Detention Pond Analyses**

### ***Analysis of the Wet Stormwater Detention Pond for the Brook Highland Shopping Center***

The following analysis was conducted by John Easton, a UAB graduate student, as part of a class assignment investigating current performance and possible retro-fit opportunities at existing wet detention ponds. The analyses included site surveys and peak flow evaluations using HydroCAD<sup>®</sup> and water quality analyses using DETPOND. This wet detention pond is located between Highway 280 and the Wal-Mart at the Brook Highland Plaza Shopping Center, in Shelby County, AL. The contributing area was estimated at 18 acres.

#### **General Quality Criteria**

##### Pond Depth

A review of the plans and specifications, in addition to on-site field evaluations, indicates that the pond meets the depth criteria of 3 to 6 feet of permanent storage which is necessary to prevent scour, decrease light penetration (to minimize rooted aquatic plant growths), and to increase winter survival of fish. This review indicates that the pond will maintain approximately 4 feet of dead water storage, but does not provide for much sediment storage. The pond might benefit from a deepened sump near the pond inlets where sediment would preferentially be captured. This would likely lower the maintenance costs for the pond by allowing easy access for removal of these larger particles.

##### Safety Criteria

The pond side slopes are 1:2 near the water edge, steeper than preferred. A 15 foot wide shelf slightly below the water surface is provided.

##### Peak Reduction Factors (PRF)

The pond significantly reduces the peak outflow rates from the contributing area. Theoretically, the 100-year storm's runoff rate is reduced from 141 cfs to about 38 cfs. The peak reduction factor ( $PRF = 1 - Q_o/Q_i$ ), for this event is 0.74, corresponding to a 74% reduction of the inflow hydrograph in the pond. For the 50-year and 25-year storms, the PRFs are 0.73. Even in the case of the 100-yr storm, the pond still has half of a foot of freeboard storage below the invert of the emergency spillway.

##### Upflow and Critical Settling Velocities

For the typical rain events, DETPOND simulations demonstrate that the pond satisfies the maximum upflow velocity (or critical settling velocity) maximum of 0.00013 ft/sec which is necessary for 5 $\mu$ m particle control.

##### Pond's Water Quality Storage

A pond's water quality storage should be equal to the runoff associated with 1-1/4" rain based on the land use, and cover of the watershed served by the pond. HydroCAD, which uses SCS TR-20 methods for computing the composite curve number, calculated a CN of 95. This 95 CN is appropriate for a commercial area, and corresponds to approximately 0.85 inches of runoff for this rain size. Therefore, the minimum active pond storage (between the invert elevation of the lowest outlet and the secondary outlet discharge devices) required should be a least 1.3 acre-ft. The pond's water quality storage is approximately 1.6 acre-ft. There is an additional freeboard storage of 4.6 acre-ft for peak runoff rate reductions.

### Pond's Surface Area Requirements

A pond's surface area should be sized as a percent of watershed's area based on land use and the particle size control desired. This site has commercial land use, with a recommended 1.7% of the watershed area needed for the pond surface area (or about 0.31 acres). The pond has a normal pool area of about 0.54 acres, exceeding this minimum recommendation.

### Other Benefits

In dry weather, the pond will be available to provide water for emergency fire protection. This pond should be a pleasing amenity for the retail mall area. The use of appropriate grasses adjacent to the pond may provide a grass filter for additional pollutant reduction.

## **Background Information Related to Site Evaluation**

### Criteria Used to Estimate Peak Flowrates

The peak inflow hydrograph values were determined by HydroCAD's SCS TR-20 methodology. For the site, a SCS Type III rainfall IDF curve was selected. Rainfall depths for the 100-year, 50-year, and 25-year storms were approximately 8.6", 7.8", and 7.1" respectively. The time of concentration ( $T_c = 5.1$  minutes) for the watershed was also calculated using HydroCAD's built-in TR-20 methods. Given that the site is commercial, with an estimated 85% impervious area, a curve number of 95 was assigned.

### Watershed Areas, Slope, and Drainage Divides

Based on the information provided in the site's grading plans (given by Sain and Associates) and field observations, it was determined that the contributing watershed area that drains into the pond has an estimated area of approximately 18 acres. Slopes were determined to be very flat in the vicinity of the pond, approximately 1 foot per 100 feet, or 1%.

## **Analysis of Design Storms**

### HydroCAD<sup>®</sup>

The HydroCAD Stormwater Modeling System (version 4.53) was used to analyze the pond for flow attenuation during drainage design storms. This computer program calculates inflowing hydrographs, based upon design storm and watershed characteristics, and then routes these through a drainage system composed of subcatchments, reaches, and ponds.

The subcatchment component is used to model a given drainage area or watershed. In this case, there was only one subcatchment, with subcatchment 1 referring to the 18.0 acres of the Brook Highland commercial shopping center that drains into the pond next to Wal-Mart. The program uses built-in SCS TR-20 hydrology methods for determining the hydrograph characteristics. Next, the hydrograph is routed through a series of defined reaches and/or ponds. In this case, there is one hydrograph from the subcatchment, which is routed through a single pond.

The pond component of this model is described using a stage v. surface area curve. In addition, the model requires descriptions of the outlet structures. This data, as input to the model, is described in Figure 58 and Table 22.



Elevation v. Surface Area  
Walmart Wet Detention Pond

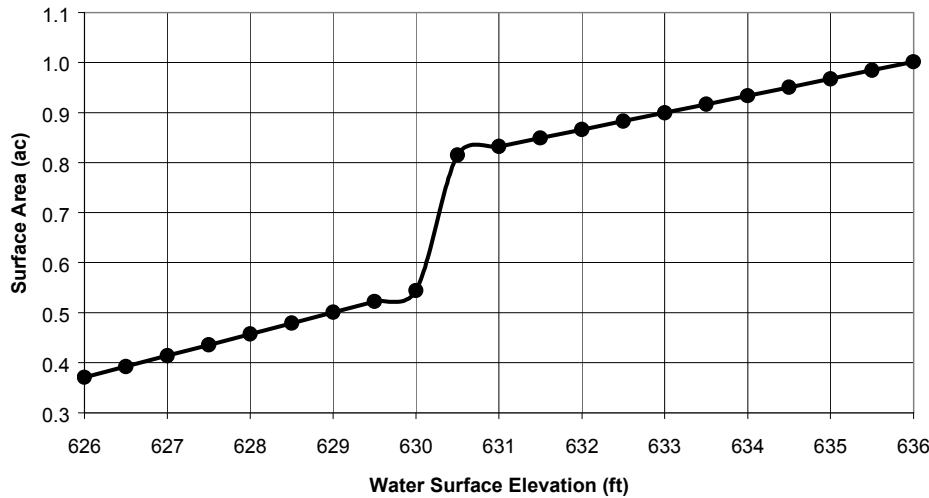

Figure 58. Stage v. Surface Area Curve

Table 22. Outlet Device Descriptions

#	Route	Invert	Outlet Devices
1	primary	630.0'	<b>36" culvert</b> n=0.013, length=38', slope=0.13%, Ke=0.5, Cc=0.9
2	to #1	630.0'	<b>30" orifice</b>
2	to #2	630.0'	<b>22" orifice (two) (partially blocked by excessive cattail growths)</b>
3	to #2	632.5'	<b>sharp-crested rectangular weir</b> length=15.7', height=3.5' (square concrete box)
4	secondary	634.5'	<b>10' broad-crested rectangular weir</b> emergency spillway

The HydroCAD simulations were run for three 24-hour, SCS type III design storm frequencies: 25-year (7.1"), 50-year (7.8"), and 100-year (8.6"). Table 23 summarizes these results. As previously mentioned, the peak reductions are about 73%, and the peak discharge lag is approximately 22 minutes. The peak elevation in the pond never reaches the maximum elevation (636 ft).

Table 23. Results of HydroCAD Simulations

Design Event	Rain Depth (in)*	Peak Elev. (ft)**	Peak Storage (AF)	Peak Qin (cfs)	Peak Qout (cfs)	Atten. (%)	Lag (min)
25-year	7.1	633.0	4.22	116.1	30.81	73	22.7
50-year	7.8	633.3	4.56	127.9	34.22	73	22.4
100-year	8.6	633.8	4.97	141.3	37.69	73	22.5

\* Design storms are type III 24-hr for Shelby county (SCS methods).

\*\* Flood elevation is at 636 feet.

## DETPOND

DETPOND uses a simplified triangular hydrograph suitable for small rains. Therefore, the SCS hydrograph generated by HydroCAD was used in DETPOND to simulate water quality benefits during these large “design” storms. A comparison of the hydraulic results from HydroCAD (Table 24) shows that the hydraulic results are similar. Even under these extreme rain conditions, the pond is expected to remove approximately 75% of the TSS.

**Table 24. DETPOND Summary for Design Storms**

Storm Year	Max. Stage (ft.)	Max. Inflow (cfs)	Max. Outflow (cfs)	Max particle size discharged (µm)	Avg. Min Particle Size Controlled (µm)	% TSS Removed
25	633.01	115.0	31.3	32.5	7.9	76.1
50	633.40	126.7	34.4	32.5	8.3	75.1
100	633.83	140.0	37.9	32.5	9.0	73.5

## Analyses Using Long-Term Rainfall Records

### DETPOND

The advantage to using DETPOND is that the program allows analyses of actual rainfall events over an extended period of time. Rain files contain start and end dates and times, plus the rain depth. The model determines the rain duration, rain intensities, and interevent periods. DETPOND then routes a simple triangular hydrograph through the pond to evaluate the expected particulate removal. For this evaluation, DETPOND simulations were conducted using rain files created from the 1976 Birmingham monitoring year (a “normal” rain year containing 112 events, based on long-term records), and also on the complete 1952 through 1989 rain record. There were 2 events (out of a total of 4,107 in the Bham5289 rain file), in which the pond stage rises to the level of the second outlet. In addition, it never reaches the emergency spillway.

**Short-term Simulation Series.** The results of the simulations using the Bham76 file are presented in Table 25. On average, the pond will collect particle sizes 1.17 µm and greater in size, which represents 97% TSS control. The average rain depth is 0.5 inches, and the average duration is 12 hours. For the smallest storms, this pond is achieving close to 100% control, and for the largest storm in 1976 the pond is still removing about 86% of the TSS. These high removals, in addition to the large peak flow rate reductions, indicates that the pond is likely over-sized, possibly in anticipation of additional area being directed to the pond as the shopping center is further developed.

**Table 25. Water Quality Output Summary for 1976 Rain Year (112 events)**

Statistic	Rain Depth (in)	Rain Duration (hrs)	Intrevent Duration (days)	Rain Intensity (in/hr)	Max Pond Stage (ft)	Flow-weighted Particle Size	Approx. Part. Res. Control* (%)	Peak Reduction Factor	Event Flushing Ratio
Mean	0.50	12.01	1.81	0.04	630.16	1.17	97	0.29	0.39
Std. Dev.	0.75	10.77	2.36	0.06	0.23	1.23	4	0.21	0.64
COV**	1.51	0.90	1.30	1.48	0.05	1.05	0.04	0.73	1.63
Min.	0.01	1.00	0.25	0.01	630.00	0.00	86	0.04	0.00
Max.	3.84	45	11.68	0.31	631.04	4.00	100	0.74	3.31

\* Approximate Particle Residue Control (TSS).

\*\* Coefficient of Variation – standard deviation divided by the mean.

Figure 59 shows the maximum pond stage versus the percent particle control. There is an expected trend as the control decreases with maximum stage, i.e., more water flowing into the pond.

Pond Stage v. Particle Residue Control  
Walmart wet pond, B'ham76

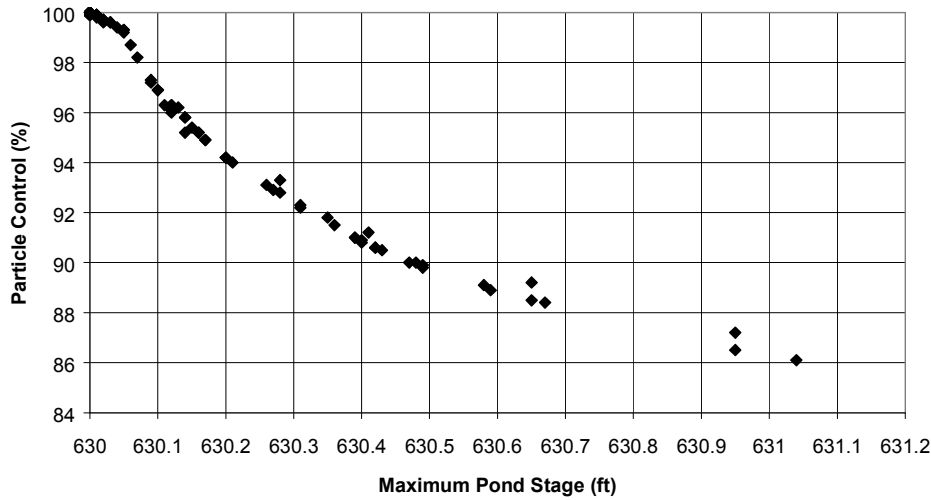
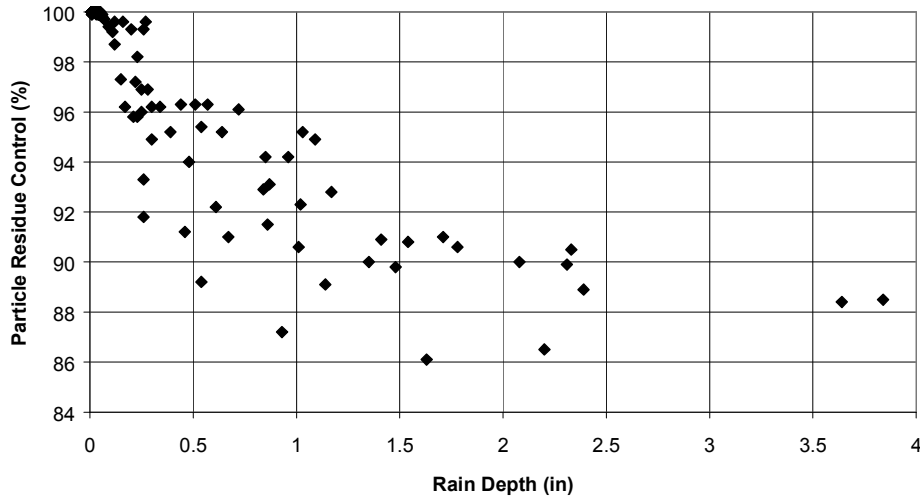

Figure 59. Pond Stage v. Particle Residue Control

Figure 60 shows the water quality performance of the pond (% particulate control) versus the rain depth in inches. Generally, the percentage TSS control decreases as the rain depth increases, as expected. The scatter is due the fact that rainfall/runoff characteristics are quite variable and depth is only one parameter. The results are similar to Figure 61 which shows the percentage TSS control versus rain intensity.

Rain Depth v. Particle Residue Control  
Walmart wet pond, Bham76



**Figure 60. Rain Depth v. Particle Residue Control**

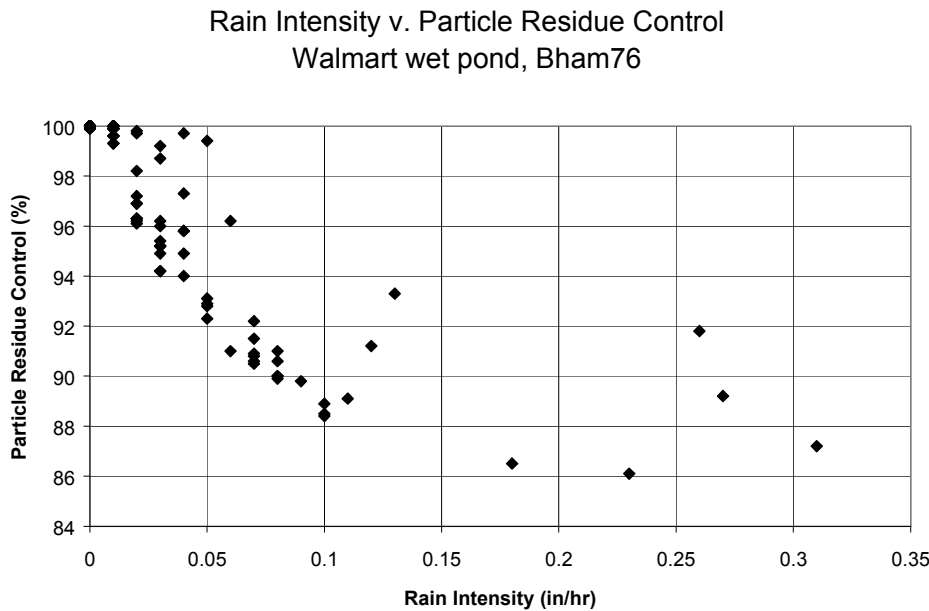

**Figure 61. Rain Intensity v. Particle Residue Control**

**Long-term Simulation using Birmingham Rain, 1952-1989.** Table 26 is a summary for the 4,107 rain events that occurred in Birmingham from 1952-1989. Notice that the minimum and maximum values are different than those from the 1976 simulations, but the mean values are quite similar, indicating that 1976 is likely a good indicator for a typical rain year. The mean particle control is about 95%, slightly less than the 97% value indicated for the 1976 rain year. This high removal rate over this extended period assumes that proper maintenance of the pond will occur.

**Table 26. Water Quality Output Summary for 1952-1989 Rain File**

Statistic	Rain Depth (in)	Rain Duration (hrs)	Intrevent Duration (days)	Rain Intensity (in/hr)	Max Pond Stage (ft)	Flow-weighted Particle Size	Approx. Part. Res. Control* (%)	Peak Reduction Factor	Event Flushing Ratio
Mean	0.50	6.31	2.57	0.09	630.26	1.64	95	0.42	0.38
Std. Dv.	0.75	6.88	3.54	0.11	0.33	1.37	5	0.22	0.62
COV**	1.50	1.09	1.38	1.31	0.00	0.83	0.05	0.52	1.62
Min.	0.01	1.00	0.00	0.00	630.00	0.00	74	0.01	0.00
Max.	13.58	93	44.31	1.45	632.41	7.70	100	0.77	8.06

\* Approximate Particle Residue Control (TSS).

\*\* Coefficient of Variation – standard deviation divided by the mean.

**Design Storm Runs Using DETPOND**

The pond inflow hydrograph from the HydroCAD analyses were used as a “user defined hydrograph” for input into DETPOND to evaluate the water quality control during these low frequency design storms. The following is an example DETPOND output file for the 25-year design event:

**25-year Design Event:**

```

Time increment (min)= 6           Number of increments= 360
Rain depth (in) (N/A for user defined inlet hydrograph): 0.00
Rain duration (days): 0.42       Event duration (days): 0.50
Interevent duration (days): 0.00
Inflow rate to pond (cfs): max= 115.0
    
```

Outflow rate from pond (cfs): min= 0.0 max= 31.3  
 time weighted ave= 2.1  
 Net inflow volume (cu ft) - event: 72615 cumulative: 72615  
 Total inflow volume to pond (cu ft): 348192  
 Outflow volumes (cu ft) - hydraulic: 275577  
 - seepage: 0  
 - evaporation: 0  
 - total outflow: 275577  
 Pond storage above lowest invert (cu ft): max = 106777  
 Pond storage below lowest invert (cu ft): 72615  
 Pond stage above datum for event (ft): min= 0.30 max= 7.01  
 Pond surface area for event (sq ft): min= 5379 max= 39223  
 Event flushing ratio (total inflow volume/pond storage below invert): 4.80  
 Upflow velocity for event (ft/hr): min= 0.000 max= 2.871  
 Minimum particle size controlled (microns): flow weighted average= 7.9  
 Particulate solids control (percent): min= 62.8 flow weighted average= 74.1  
 Peak Reduction Factor (PRF): 0.73  
 \*\*\* The largest ave particle size discharged during any time increment: 12.1  
 microns

Particle Size Distribution

Percent of Particles Larger than Size Indicated	Pond Inflow During Event	Theoretical ***	n=8	n=3	n=1	Defined n = 5
0 >	2000.0	7.9	21.0	32.5	233.3	32.5
10 >	233.3	6.9	8.7	10.0	15.3	8.9
20 >	95.0	5.9	7.0	7.6	10.1	7.2
30 >	53.3	5.2	5.4	5.8	7.7	5.5
40 >	32.5	4.5	4.6	4.8	5.9	4.7
50 >	21.0	3.8	3.7	4.0	4.8	3.8
60 >	13.5	3.1	2.9	3.1	3.7	3.0
70 >	9.0	2.3	2.2	2.3	2.7	2.2
80 >	5.7	1.6	1.5	1.5	1.8	1.5
90 >	3.0	0.8	0.7	0.8	0.9	0.7
100 >	0.0	0.0	0.0	0.0	0.0	0.0
Row A:		12.1	21.0	32.5	233.3	32.5
Row B:		7.9				
Row C:		74.1	76.6	75.3	70.6	76.1

Row A: Largest ave particle size discharged (microns) during any time event  
 Row B: Flow weighted average minimum particle size controlled (microns)  
 Row C: Percent particulate solids removed

**Site Photographs**

Facing west, inlets on right, obscured by cattails.



Facing North, showing parking area that drain to pond.



Outlet structure, showing cattails partially blocking the 22 in orifices through concrete wall.



***The Use of DETPOND to Evaluate Wet Detention Pond for Minneapolis-St. Paul Airport***

This discussion is summarized from a report originally prepared by Robert Pitt for Liesch Associates, Inc., in August 1999.

**Long-Term Rain and Runoff Analyses for Minneapolis**

The critical values defining the important rain categories affecting receiving water uses are highly dependent on local rain and development conditions. Computer modeling analyses for 7 years of rains for Minneapolis (1982 through 1989) were therefore conducted to examine the runoff distributions for typical residential and commercial areas. The plots from this modeling activity (shown in Figure 62) indicate the rainfall and runoff probability distributions. The complexity of most receiving water quality problems prevents a simple analysis. The use of simple design storms, which was a major breakthrough in effective drainage design more than 100 years ago, is not adequate when receiving water quality issues must also be addressed.

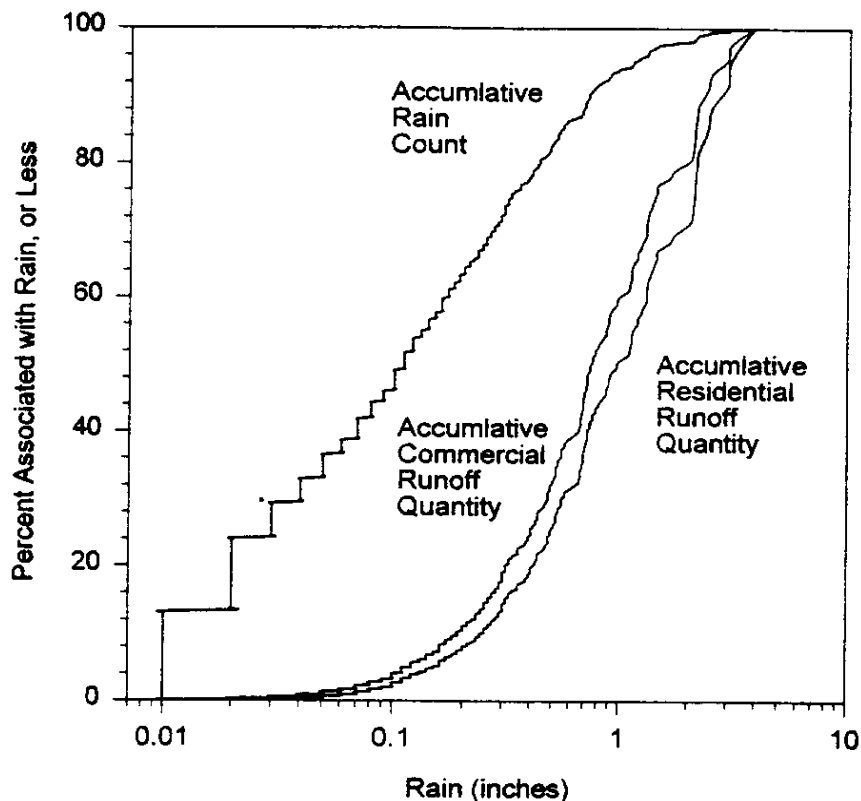

Figure 62. Recorded rain count and modeled runoff volume distributions for Minneapolis, MN (1983 through 1989).

These simulations were based on 7 years of rainfall records (1983 through 1989), from the NOAA station at the Minneapolis-St. Paul airport and were obtained from CD-ROMs distributed by EarthInfo of Boulder, CO. Hourly rainfall depths for the indicated periods were downloaded from the CD-ROMs into an Excel spreadsheet. The files were slightly modified (by eliminating the daily total rainfall column) and saved as a comma delineated file. This file was then read by an utility program included in the SLAMM package. This rainfall file utility combined adjacent hourly rainfall values into individual rains, based on user selections (at least 6 hrs of no rain was used to separate adjacent rain events and all rain depths were used, with the exception of the “trace” values). These rain files for each city were then used in SLAMM for typical medium density and strip commercial developments. The median rainfall was 0.11 inches, while rainfall depths of about 0.73 to 1.0 inch correspond to the median runoff depth, depending on the land use.

The CDF plot (Figure 62) shows two distinct “breakpoints” which separate the distributions into the following three general categories:

- less than lower breakpoint: small, but frequent rains. These generally account for 50 to 70 percent of all rain events (by number), but only produce about 10 to 20 percent of the runoff volume throughout the U.S. Figure 62 shows that the rain depth for this breakpoint was about 0.22 inches for Minneapolis during this 7 year period, and 68% of all rains were less than this value. Nine to 13% of the runoff volume was associated with these smaller rains, depending on the land use. These events are therefore most important because of their frequencies, not because of their mass discharges. These rains are therefore of great interest where water quality violations associated with urban stormwater occur. This would be most common for bacteria (especially fecal coliforms) and for total recoverable



heavy metals which typically exceed receiving water numeric criteria during practically every rain event in heavily urbanized drainages having separate stormwater drainage systems.

- between the lower and upper breakpoint: moderate rains. These rains generally account for 30 to 50 percent of all rains events (by number), but produce 75 to 90 percent of all of the runoff volume throughout the U.S. Figure 62 shows that the rain depth of this upper breakpoint is about 2.8 inch for Minneapolis during this 7 year period, and about 84% of all runoff was between the two breakpoints, while only 32% of the rains were in this range. These intermediate rains also account for most of the pollutant mass discharges and much of the actual receiving water problems associated with stormwater discharges.

- above the upper breakpoint: large, but rare rains. These rains include the typical drainage design events and are therefore quite rare. During the period analyzed, less than 1 percent of the rains were greater than this breakpoint (only 11 events in 38 years, including a 10 inch rain that occurred on July 23, 1987, as shown in Table 27). These rare events accounted for about 5 percent of the runoff on an annual basis, as shown on Figure 62. Obviously, these events must be evaluated to ensure adequate drainage and for habitat protection.

**Table 27. Very Large Rains Occurring from 1952 to 1990 at Minneapolis-St. Paul International Airport**

Date	Rain Depth (inches)	Rain Duration (hours)
6/25/78	2.88	8
6/7/84	2.94	12
6/21/86	3	10
5/31/65	3.01	13
10/14/66	3.13	32
10/7/70	3.2	61
8/26/78	3.65	14
7/20/87	3.8	9
7/7/55	3.89	9
8/30/77	7.35	11
7/23/87	10	6

A continuous analysis of proposed water quality control practices is therefore needed in order to evaluate how the proposed practices affect the rains in each of these three major categories.

**Estimated Performance of Minneapolis-St. Paul International Airport Pond Design**

DETPOND was used to evaluate the proposed pond at the Minneapolis-St. Paul International Airport. Table 28 is a summary of the overall pond performance for the three major rain categories described above, while Figure 63 shows the expected performance plots for this pond, and Figure 64 shows the predicted rainfall-runoff relationship for the airport drainage. Obviously, the smaller rains and flows experience a much greater level of treatment than the larger rains. The following summarizes the overall expected pond performance:

- the flow-weighted particle size control is about 5.1  $\mu\text{m}$ , corresponding to an estimated flow-weighted suspended solids control of about 89% using the “midwest” particle size distribution.
- if using the “low” particle size distribution (made up predominately of smaller particles), then the estimated flow-weighted suspended solids control would be about 65%.
- if using the “high” particle size distribution (made up predominately of larger particles), then the estimated flow-weighted suspended solids control would be about 97%.

Table 29 is a statistical summary of the modeled pond performance for this proposed pond for the 38 year analysis period. This period contained almost 4,000 events, ranging from 0.01 to 10 inches, with interevent periods ranging up to 34 days. Only about 1% of the total pond outflow occurred as evaporation and only about 10% of the pond water was displaced during the median rain event. The pond displacement volume (the water volume in the pond at the beginning of the event) was about equal to a 0.5 inch rainfall. The intermediate rainfall category (0.22 to 2.8 inches) had event flushing ratios ranging from 0.25 to 6.8, with most of the events in this critical category displacing several times the pond volume during the event period. In other words, most of the treatment is likely occurring during the relatively short runoff period (5 to 24 hours) as dynamic settling and not during interevent periods as quiescent settling.

**Table 28. Predicted Wet Detention Pond Performance at Minneapolis-St. Paul International Airport**

Rain category	Occurrence of rains in this category (% of all rains)	Rain range (inches)	Predicted critical particle size control ( $\mu\text{m}$ ) (flow-weighted)	Predicted suspended solids control (%) (flow-weighted)	Percentage of annual runoff volume in category
Frequent, small rains	68%	<0.22 inch	1.0 $\mu\text{m}$	99%	8.8%
Common, intermediate rains	32%	0.22 to 2.8 inches	4.8 $\mu\text{m}$	89%	84.1%
Rare, large rains	<1% (11 in 38 years)	>2.8 inches	15 $\mu\text{m}$	71%	7.1%

The first category, the most frequent, but smallest rains, account for about 68% of all rains (by count), but only 8.8% of the airport runoff quantity. These rains are most significant from a water quality standard violation standpoint, as almost all rains are likely to exceed water quality standards for bacteria and some of the total recoverable heavy metals. Much of these flows would be infiltrated through the grass-lined drainages at the airport. The directly-connected impervious areas draining directly to the drainage systems and the proposed detention pond will contribute most of the expected flows during these small rains. The proposed detention pond will remove almost all of the suspended solids in the runoff, and much of the associated other pollutants (especially the heavy metals) during these small rains, greatly reducing the frequency of water quality violations.

The intermediate category of rains are responsible for most of the annual runoff volume (84.1%). Runoff from this category of rains would most likely be responsible for most of the receiving water problems. Much of the runoff from the smallest rains in this category would likely be infiltrated at the upland grass waterways, but the larger rains would produce some runoff from these “disconnected” areas in addition to most of the runoff from the directly connected paved areas. The proposed pond is estimated to remove most of the particulate pollutants greater than about 5  $\mu\text{m}$  in size (and about 89% of the suspended solids) from the runoff from these rains.

The third category of rains (>2.8 inches) account for only 7.1% of the annual airport runoff, and originate from only 0.3% of the rain events. Fifteen events over the 38 years would have been expected to cause an overflow of the emergency spillway of the pond, possible causing catastrophic pond failure (especially the maximum 10 inch rain, while the other excessive rains would have produced much less of an overflow). The proposed pond design therefore has a bypass structure that will divert large flows around the pond and discharge them directly into the Minneapolis River untreated. A later discussion presents an analysis to recommend the bypass flow rate. The water treated in the pond in this category would provide capture of all particulates greater than about 15  $\mu\text{m}$ , corresponding to a suspended solids level of control of about 71%.

The estimated long-term averaged suspended solids control is therefore about 88%, mostly associated with the intermediate-sized events.

### Minneapolis Airport Performance

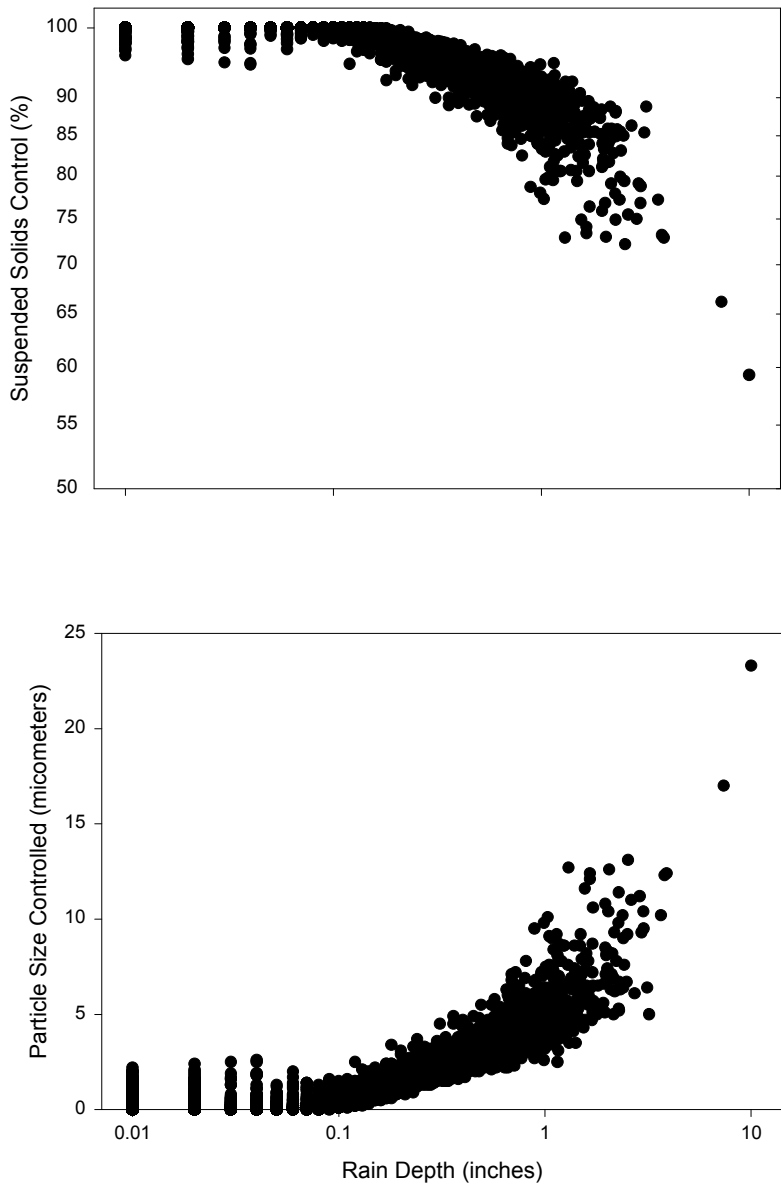
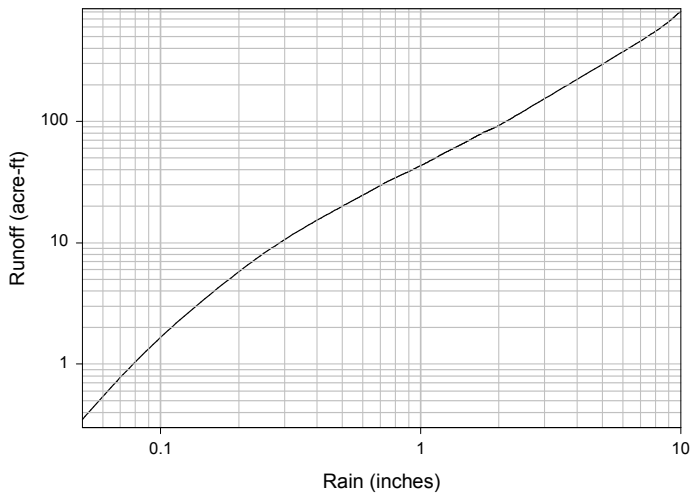

Figure 63. Suspended solids and particulate control as a function of rain depth.

Table 29. Pond Performance Summary for 38 Year Rain Series for Proposed Airport Pond Design

	3997	3997	3997	3997	3997	3997	3997	3997	3997	3997	3997	3997	3997	3997	3997	3997	3997
Rain depth (in)	1033	24829	6.21	2.66	0.05	5.81	6.25	5.24	3997	3997	3997	3997	3997	3997	3997	3997	3997
Rain duration (hrs)			4.00	1.46	0.02	5.81	6.25	5.24	3997	3997	3997	3997	3997	3997	3997	3997	3997
Interevent duration (days)		10647	1.00	0.00	0.00	4.89	6.25	5.24	3997	3997	3997	3997	3997	3997	3997	3997	3997
Rain intensity (in/hr)			79.00	34.31	1.67	25.34	6.25	5.24	3997	3997	3997	3997	3997	3997	3997	3997	3997
Minimum pond stage (ft)			6.8	3.4	0.08	1.24	5.0	29	3997	3997	3997	3997	3997	3997	3997	3997	3997
Maximum pond stage (ft)			0.90	0.76	0.58	5.0	5.0	29	3997	3997	3997	3997	3997	3997	3997	3997	3997
Event inflow volume (ac-ft)			10.01	1.67	0.01	807	23.7	0.42	3997	3997	3997	3997	3997	3997	3997	3997	3997
Event hydraulic outflow (ac-ft)			2.24	0.00	0.00	807	23.4	0.42	3997	3997	3997	3997	3997	3997	3997	3997	3997
Event evaporation outflow (ac-ft)			0.05	0.00	0.00	1.25	0.14	0.75	3997	3997	3997	3997	3997	3997	3997	3997	3997
Event total outflow (ac-ft)			10.00	2.36	0.01	807	23.4	0.42	3997	3997	3997	3997	3997	3997	3997	3997	3997
Flow-weighted particle size controlled ( $\mu\text{m}$ )			1.45	5.08	0.60	23.30	1.94	0.74	3997	3997	3997	3997	3997	3997	3997	3997	3997
Approximate suspended solids control (%)			97.31	89.24	99.90	59.30	100.00	4.40	3997	3997	3997	3997	3997	3997	3997	3997	3997
Peak reduction factor			0.68	0.76	0.02	1.00	0.26	2.5	3680	3680	3680	3680	3680	3680	3680	3680	3680
Event flushing ratio			0.61	0.10	0.00	49.04	1.44	0.42	3997	3997	3997	3997	3997	3997	3997	3997	3997
number total		3997							3997	39980	3997						
% flow out																	
num avg																	
fl wt avg																	
median																	
min																	
max																	
st dev																	
COV																	
1%																	
5%																	
10%																	
20%																	
25%																	
30%																	
40%																	
50%																	
60%																	
70%																	
75%																	
80%																	
85%																	
90%																	
91%																	
92%																	
93%																	
94%																	

95%	1.05	20	9.67	0.17	8.81	5.58	46.1	44.9	0.39	45.	5.3	100	0.98	2.8
96%	1.16	22	10.63	0.19	9.02	5.63	51.8	50.6	0.43	50.	5.7	100	0.98	3.1
97%	1.30	24	11.93	0.22	9.26	5.68	57.8	57.5	0.48	57.	6.3	100	0.98	3.5
98%	1.51	27	13.07	0.27	9.53	5.77	69.0	69.8	0.58	69.	6.9	100	0.98	4.1
99%	1.99	32	15.85	0.37	10.12	5.90	93.8	92.7	0.74	92.	8.3	100	0.99	5.6
99.50%	2.32	38	19.28	0.46	10.69	5.99	112.	111.	0.90	111.	9.8	100	0.99	6.8
99.90%	3.65	48	24.69	0.89	12.15	6.25	192.	190.	1.12	190.	12.6	100	0.99	11.
100%	10	79	34.31	1.67	25.34	6.48	807.	807.	1.24	807.	23.3	100	1.00	49.



**Figure 64. Rainfall-runoff relationship for airport drainage.**

**Bypass of Excessive Flows around Pond**

All low flows will be directed to the pond. However, certain peak flows will be discharge directly to the Minnesota River without passing through the pond, although flows less than this cutoff flow will be discharged to the pond. The diversion will consist of an orifice at the bottom of the storm sewers which will direct the flows below the critical cutoff flow to the pond. A shallow dam will be located immediately downstream to create a head. The excessive flows overtopping this diversion dam will be directed to the river. This diversion structure will not have any type of machinery to ensure safe and unhampered operations.

Various bypass amounts were examined to prevent the pond from exceeding the 10 ft and 11 ft elevations, using a 3.89 inch type II hydrograph for the site. All influent flows in the influent hydrograph greater than the bypass amount were replaced with the values shown as the bypass amount, allowing the truncated hydrograph to flow to the pond. It is assumed that the excessive flows would then be bypassed to the river directly. Table 30 summarizes the results of these analyses.

**Table 30. Evaluation of Alternative By-pass Flows Around Proposed Airport Pond**

bypass cutoff	peak stage	hrs >10 ft	hrs >11 ft	max size	%SS reduc
none	13.8 ft.	2.5 hrs	1.7 hrs	19.3 μm	75
500 cfs	11.7	2.2	1.2	15.5	79
400	11.2	2.0	0.7	14.2	81
350	10.9	1.8	0	13.5	82
300	10.6	1.5	0	12.6	83
200	10.0	0	0	6.8	85

Therefore, all flows greater than 200 cfs should be diverted around the pond to keep it from exceeding the 10 ft pond elevation (giving a one foot freeboard), while all flows greater than 350 cfs should be diverted around the pond to keep it from over-topping the 11 ft. roadway elevation.

A conservative estimate is that a “typical” 0.7 inch rain (having a duration of about 6 hrs) may produce a peak runoff of about 200 cfs, depending on the rain intensity variation during the rain. Similarly, a 1 inch rain (again with a duration of about 6 hrs) may produce a peak runoff rate of about 350 cfs. The 0.7 inch rain (or greater) occurs about 10 times a year (based on an analysis of 38 years of Minneapolis-St. Paul airport rainfall data), while the 1 inch rain (or greater) occurs about 5 times a year. As indicated above, the by-passes are for only portions of these events, not for the whole events. Very little of the runoff volume would be by-passed during rains close to these “cutoff” rains, but larger portions of larger events would be bypassed.

As shown on Table 31, about 95% of the annual runoff volume (would vary due to actual rain durations) would pass through the pond with a 200 cfs bypass. This assumes that the first 200 cfs of all events would pass through the pond, and the excess flows would be diverted around the pond untreated. This estimate assumes about 80% of the maximum volume calculated using a constant 200 cfs flow rate and the runoff duration would be treated in the pond. This decrease is due to delays in the rising limb and extended recession limbs of the inflow hydrographs (the geometry of the inflowing hydrograph would truncate the upper corners of the assumed rectangular hydrograph if using a constant 200 cfs flow for the total event duration). The water passing through the pond would receive good treatment, as noted elsewhere in this report (likely greater than 80% SS reduction, even using the “worst-case” type II hydrograph for the largest events).

**Table 31. Amount Treated by Pond, with By-Pass (First 200 CFS of Each Event Treated in Pond)**

Rain Depth (in)	Approx. Runoff Duration for this Duration (hrs)	Potential Volume Treated in Pond (acre-ft) <sup>1</sup>	Runoff Depth for this Rain (ac-ft)	Volume Bypassed (ac-ft)	Volume Treated in Pond (ac-ft)	% of Runoff Treated in Pond	% of Annual Runoff Volume for this Rain Depth, and Less	% of Annual Runoff in Range <sup>2</sup>	Average % Treated in Range	Incremental Amount of Runoff Treated in Range
0.09	2	26	1	0	1	100	1	1.0	100	1.0
0.17	3	40	5	0	5	100	5	4.0	100	4.0
0.24	3	40	8	0	8	100	10	5.0	100	5.0
0.38	6	79	14	0	14	100	20	10.0	100	10.0
0.44	6	79	17	0	17	100	25	5.0	100	5.0
0.49	6	79	20	0	20	100	30	5.0	100	5.0
0.67	6	79	27	0	27	100	40	10.0	100	10.0
0.81	6	79	35	0	35	100	50	10.0	100	10.0
1.04	6	79	45	0	45	100	60	10.0	100	10.0
1.32	6	79	57	0	57	100	70	9.9	100	9.9
1.45	6	79	64	0	64	100	75	5.0	100	5.0
1.65	6	79	76	0	76	100	80	5.1	100	5.1
1.96	10	132	94	0	94	100	85	5.0	100	5.0
2.28	10	132	112	0	112	100	90	4.9	100	4.9
2.4	10	132	118	0	118	100	91	1.2	100	1.2
2.51	10	132	125	0	125	100	92	0.9	100	0.9
2.72	10	132	137	5	132	97	93	1.2	98	1.2
3.01	10	132	155	22	132	85	94	1.1	91	1.0
3.13	10	132	161	28	132	82	95	0.8	84	0.7
3.8	10	132	198	65	132	67	96	1.4	75	1.0
3.89	10	132	204	71	132	65	97	0.5	66	0.3
7.35	15	198	490	292	198	40	98	1.2	53	0.6
10	15	198	808	609	198	25	100	2.0	33	0.7

sum: 97

<sup>1</sup> at 80% of maximum potential due to geometry of inflow hydrograph truncating upper corners of rectangular hydrograph

<sup>2</sup> between rain depth and next smaller rain depth

### Short-Circuiting Factor Effects

The Hazen equation illustrates how DETPOND considers “short-circuiting”. This method is based on a specific volume of water passing through the pond faster than the average residence time, providing less treatment. Short-circuiting is calculated assuming hypothetical ponds in series: little short-circuiting is possible if many ponds are connected in series, while more will occur when few ponds are connected. The main effect of short-circuiting is an increase in the number of large particles that may pass through a pond. Table 32 summarizes multiple evaluations of

the proposed airport pond for different short-circuiting factors. The following list summarizes the observations from these analyses:

- short-circuiting increases the discharge of large particles, but with relatively small increases in suspended solids discharges.

- the effects of short-circuiting are worse for larger events (and for smaller ponds). The worst reduction in SS reductions was for the very large 10 inch rain, where the theoretical SS removal was 59%, while the SS removal for very poor short-circuiting conditions (n=1) was reduced to about 56%.

- the elongated pond shape and the isolated inlets and outlets are expected to result in a pond with little short-circuiting.

- the largest particle sizes discharged for very good short-circuiting conditions (n=8) is about 9  $\mu\text{m}$  for 0.25 inch rains, about 13.5  $\mu\text{m}$  for 0.7 inch rains, 22  $\mu\text{m}$  for 1 inch rains, and 34  $\mu\text{m}$  for 2 inch rains. Again, few of these large particles would actually be discharged.



**Table 32. Effects of Different Short-Circuiting Factors on Pond Performance**

Event percentile	Exceedence frequency (#/yr)	Rain depth (in)	Rain duration (hrs)	Inflow volume (ft <sup>3</sup> )	Maximum pond stage (ft)	Flushing ratio	Peak reduction factor	Max. part. Size trapped (theoretical)	Flow-weighted part. Size (theoretical)	Percent suspended solids removal (theoretical)	Max. part. Size trapped (n=8)	Percent SS removed (n=8)	Max. part. Size trapped (n=3)	Percent SS removed (n=3)	Max. part. Size trapped (n=1)	Percent SS removed (n=1)
1	107	0.01	1	613	5.01	0	1	0	0	100	0	100	0	100	0	100
5	103	0.01	1	613	5.01	0	1	0	0	100	0	100	0	100	0	100
10	97	0.01	1	613	5.01	0	1	0	0	100	0	100	0	100	0	100
20	86	0.02	2	2,450	5.02	0	1	0	0	100	0	100	0	100	0	100
30	76	0.03	2	5,510	5.04	0.01	1	0	0	100	0	100	0	100	0	100
40	65	0.06	2	22,400	5.14	0.03	1	0	0	100	0	100	0	100	0	100
50	54	0.10	3	72,700	5.43	0.10	0.97	0.2	0.1	100	0	100	0	100	0	100
60	43	0.16	3	185,000	5.97	0.26	0.92	1.3	0.9	99.7	0	100	0	100	0	100
70	32	0.25	3	357,000	6.58	0.50	0.81	2.5	1.8	97.1	9	97.6	13.5	97.1	175	95.0
80	22	0.40	6	678,000	7.41	0.95	0.64	4.1	3.0	93.7	9	94.3	13.5	93.7	175	91.1
90	11	0.69	6	1,270,000	8.4	1.77	0.46	6.1	4.5	90.1	13.5	90.7	22.0	89.9	175	86.4
95	5	1.05	6	2,020,000	9.24	2.82	0.30	8.4	6.2	86.2	22.0	87.2	33.8	86.2	380	82.1
99	1	1.99	6	4,140,000	10.66	5.78	0.16	12.7	9.7	78.2	33.8	80.5	55.0	79.2	380	74.7
100	0	10	6	35,100,000	25.34	49.04	0.12	26.9	23.5	59.0	92.0	62.7	175	61.3	2000	56.4

### Sizing and Performance of Airport Wet Detention Pond Based on Simple Design Criteria

As a comparison to the preliminary pond design, an airport wet detention pond was sized based on simple guidance, ignoring actual site constraints. The performance of this pond was also evaluated using 38 years of airport rainfall data.

The first criteria in sizing a detention pond for water quality is to provide a surface area equal to about 3% of the paved drainage area in order to control particles larger than about 5  $\mu\text{m}$ . For the airport site, 353 acres of pavement will drain to the pond, along with 622 acres of sandy soil pervious areas and 210 acres of pavement that is drained through surface swales across the sandy soil. Because of the high rate of infiltration of the sandy soil, the pond can be sized only for the directly connected paved area. Therefore, the optimal pond design would include a permanent pond surface area of about 10.6 acres.

The second criteria in sizing a pond is to provide a “live” storage volume equal to the runoff volume associated with a rain of about 1.25 inches in depth. Figure 64 is a plot of the estimated runoff volumes (in acre-ft) associated with different rain depths. This plot was produced using DETPOND output data for almost 4,000 rains ranging from 0.05 to 10 inches and for the tributary areas shown above. This plot shows that a rainfall of 1.25 inches would produce about 55.6 acre-ft of runoff. Table 33 lists the resulting side slopes associated with different pond depths.

**Table 33. Side Slope Calculations of Full-Size Airport Pond**

Depth (above the normal water elevation)	Pond area at this depth	Resulting side slope of pond
2 ft.	46 acres	0.5%
3	27	1.3
4	17.0	3.9
5	11.7	25

In order to construct a pond having this volume, normal surface area, and a side slope of about 4%, the live storage pond depth above the normal water level would be about 4 feet. The surface area at 4 ft above the normal pond surface would therefore be about 17 acres.

The final criteria in sizing a wet detention pond is to select the outlet devices to provide at least 5  $\mu\text{m}$  control at all pond stages. The critical settling velocity of a 5  $\mu\text{m}$  particle is about  $1.3 \times 10^{-4}$  ft/sec. The maximum outlet discharge is equal to this velocity times the surface area (the surface overflow rate). Several choices are possible with this pond, including: a single 90° v-notch weir, two 60° v-notch weirs, a 5 ft. sharp-crested rectangular weir (a little too large), or two 36 inch vertical drop structures. Table 34 summarizes these outfall options.

**Table 34. Alternative Discharge Devices for Full-Size Airport Pond**

Stage above lowest invert	Pond area at this stage	Maximum allowable discharge at this stage for 5 $\mu\text{m}$ control	Discharge for a single 90° v-notch weir	Total discharge for two 60° v-notch weirs	Discharge for a single 5 ft. sharp-crested rectangular weir	Total discharge for two 36" drop structures
0 ft	10.6 acres	60 cfs	0	0	0	0
1	12.2	69	2.5	2.8	16	14
2	13.8	78	14	16	43	56
3	15.4	87	39	56	80	84
4	17.0	96	80	92	110	84

The 60° v-notch weirs provide the best solution because they are the closest fit at the 4 ft stage, while providing substantially better performance at lower elevations than the rectangular weir or the drop structures.

In addition to these “water quality” discharges, another spillway needs to be provided for rarer events that may not be contained within these outlet devices. A rectangular weir 7.8 ft long and 2.5 ft high extending from the 4 ft stage (above the normal water surface) was included in the preliminary design and was therefore used for this design. In addition, a road crossing provides another emergency spillway for rare storms.

This pond design was evaluated using the rain history (3997 separate events) from the 38 year period from 1952 through 1989. Table 35 summarizes the performance of this hypothetical pond, for comparison to the proposed pond design. This larger pond provides a flow-weighted control for particles greater than 2.2  $\mu\text{m}$ . For the “midwest” particle size distribution, this corresponds to an approximate flow-weighted suspended solids control of about 96%. Using the “low” particle size distribution, this would correspond to an approximate flow-weighted suspended solids control of about 85%, and using the “high” particle size distribution, this would correspond to an approximate flow-weighted suspended solids control of about 99%. Particles larger than 5  $\mu\text{m}$  (at least) would be theoretically trapped in the pond whenever the surface water elevation was below the rectangular weir. If the pond water elevation was near the invert of the v-notch weirs, then the particle size control would be much better. Similarly, whenever the pond water level is within the rectangular weir, particles larger than 5  $\mu\text{m}$  would be discharged. Of course, it is likely that some particles larger than 5  $\mu\text{m}$  would be discharged at lower pond surface elevations due to potential short-circuiting. As shown previously, with large short-circuiting (not expected with the elongated design of the pond) the discharge of some large particles would occur, but the pond suspended solids control is only reduced by a small amount. This larger pond therefore has a relatively large marginal improvement over the proposed pond design (96% vs. 88%), but at about three times the area. However, this larger pond is not suitable for the site because of limited available space at the airport.



### **Suggested Pond Modifications to Enhance Performance**

The following discussion presents some suggestions to further enhance the performance of the proposed wet detention pond at the Minneapolis-St. Paul International Airport. The most important enhancements relate to special winter operations, where the pond water level should be drawn down during the winter to isolate the sediments by ice from snowmelt that may otherwise flow under the ice. This would also increase the effective storage volume for snowmelt and provide additional storage for winter runoff that may be contaminated by de-icing compounds. This would allow the winter runoff to be pumped to separate facilities for treatment of the de-icing compounds.

Another suggested enhancement would be to add a capability for surface aeration to the pond. This would increase mixing during interevent periods to reduce stratification, increase photo-degradation of toxicants, and provide an excess of dissolved oxygen (especially important considering the very high BOD<sub>5</sub> of common de-icing compounds that may enter the pond). Aeration could be used intermittently, depending on the pond conditions.

A subsurface outlet would enhance floatable control and would minimize icing problems. The outlet pipe should be located near the bottom of the pond, but on a sealed surface to minimize scour. The outlet pipe would then be connected to a large subsurface box where the outlet control weir is located. This box would also be outfitted with lower outlet controls for winter operation and for complete drainage of the pond for any required maintenance.

It is strongly suggested that a fore-bay be installed near the pond inlet to minimize the area where most of the sediment would accumulate. The area for the fore-bay should be between 10 and 20% of the total pond area and be separated from the main pond by a subsurface weir/dam (located below the low winter operational pond level). Special access provisions should be provided adjacent to this area to enable easy access to dredging equipment.

The inlet leading to the pond could also be provided with chemical feed facilities to allow chemical treatment under severe conditions. The use of alum has been shown to be problematic in northern areas where pH and buffering capacity of the water may be low, causing aluminum toxicity. However, alum is easy to apply and the floc can be discharged into the pond where it is relatively stable. Ferric chloride is generally a superior coagulant for stormwater, especially in northern areas, allowing the faster formation of a more stable floc that settles much more rapidly than an alum floc. Unfortunately, a ferric chloride floc becomes unstable under anaerobic conditions, which may occur near the sediment interface in a wet detention pond. Therefore, ferric chloride flocs are usually removed before discharge. It may be possible to capture most of the floc in the recommended fore-bay, and to ensure aerobic conditions there through the use of aeration in that area.

Finally, there are special recommendations for the use of wet detention ponds at airports that need to be addressed. These have to do with aircraft safety, especially by not providing an attraction to birds. Heavily vegetated perimeters of a pond generally decrease the pond's attractiveness to geese, but they also provide habitat to other wildlife and are not recommended by the FAA. The linear shape of the proposed pond meets the FAA's recommendations, but it is a wet pond, whereas they recommend dry ponds. Unfortunately, dry ponds do not provide adequate water quality treatment. They also recommend steep sides that are rip-rap lined, with minimal vegetation to discourage wildlife. The nearby location of the Valley National Wildlife Refuge and Meadow Lake may make this proposed wet detention pond much less attractive to wildlife than if it was the only body of water in the region.

### **Special Issues Associated with Wet Detention Ponds at Airports**

The FAA published an Advisory Circular (No. 150/5200-33) on May 1, 1997 discussing hazardous wildlife attractants on or near airports. They list the wildlife that have been involved in damaging collisions with civilian aircraft in the U.S. in 1993 – 1995. Waterfowl were involved in 28% of the collisions and wading birds were involved in another 3%. Because of this, they are concerned about land use practices on and near airports that may attract waterfowl. The recommended distance between an aircraft's movement areas, loading ramps, or aircraft parking areas and any wildlife attractants is 10,000 ft for airports serving turbine-powered aircraft, and 5 miles if the wildlife attractant may cause hazardous wildlife movement across or into the approach or departure airspace.

They recommend that artificial marshes (wetland treatment systems for wastewater) not be located within these separation distances. They also recommend against the discharge of wastewater to unpaved airport areas, as the resultant soft or muddy conditions can severely restrict or prevent emergency vehicles from reaching accident sites in a timely manner. These incompatible land uses specifically deal with wastewater treatment facilities and not to stormwater. However, the issues may be similar. Obviously, many airports utilize grass swales to drain airport pavement areas. It is imperative that these swales are designed to minimize standing water and provide good infiltration conditions. Longitudinal infiltration trenches along the swale's lengths, or at least intermittent infiltration areas, could be provided to ensure adequate drainage in these areas. Wetland treatment of airport runoff may also be of concern.

The FAA also lists land uses that may be compatible with safe airport operations, specifically addressing stormwater dry and wet detention ponds. In general, the FAA does not consider these activities to be hazardous to aviation if there is no apparent attraction to hazardous wildlife, or wildlife hazard mitigation techniques are implemented to deal effectively with any wildlife hazard that may arise. They state that both dry and wet detention ponds control runoff (a necessary activity for safe aircraft operations), but also can attract hazardous wildlife. To best control hazardous wildlife, the FAA recommends using steep-sided, narrow, linearly-shaped, rip-rap lined dry detention ponds rather than wet detention ponds. Whenever possible, these ponds should be placed away from aircraft movement areas and that all vegetation in or around dry or wet detention ponds that provide food or cover for hazardous wildlife be eliminated. They also state that if soil conditions permit, the use of underground stormwater infiltration systems, such as French drains or buried rock field be used because they are less attractive to wildlife.

#### **DETPOND Input File for Proposed Minneapolis Airport Wet Detention Pond**

Pond file name: K:\WDP71\AIRPORT.PND  
Pond file description: basic Minn/St Paul airport file  
Particle Size file name: K:\WDP71\MIDWEST.CPZ  
Output Format Option: Water Quality Summary: One Line per Event  
Output device: Print Output to File (extension .DPO)  
Date: 06-29-1999

#### Drainage Basin Runoff Procedure:

##### Combined Surface Characteristics

1. All directly connected impervious areas (acres): 353
2. All pervious areas (acres): 622
3. All impervious areas draining to pervious areas (acres): 210

#### Outlet Characteristics:

##### Outlet number 1

##### Outlet type: V - Notch Weir

1. Weir angle (degrees): 90
2. Weir height from invert: 6
3. Invert elevation above datum (ft): 5

#### Outlet Characteristics:

##### Outlet number 2

##### Outlet type: Rectangular Weir

1. Weir length (ft): 7.8
2. Weir height from invert: 2.5
3. Invert elevation above datum (ft): 8.5

#### Outlet Characteristics:

##### Outlet number 3

Outlet type: Evaporation

Month Number	Evaporation (in/day)
1	.01
2	.01
3	.03
4	.06
5	.1
6	.13
7	.18
8	.18
9	.14
10	.1
11	.04
12	.01

Initial stage elevation (ft): 5  
 User defined pond efficiency factor (n): 5

Pond Stage, Surface Area, and Stage-related Outfall Devices (if applicable)

Entry Number	Stage (ft)	Pond Area (acres)	Natural Seepage (in/hr)	Other Outflow (cfs)
0	0.00	0.0000	0.00	0.00
1	1.00	3.0500	0.00	0.00
2	2.00	3.3500	0.00	0.00
3	3.00	3.6500	0.00	0.00
4	4.00	4.0000	0.00	0.00
5	5.00	4.4000	0.00	0.00
6	6.00	4.8000	0.00	0.00
7	7.00	5.2000	0.00	0.00
8	8.00	5.6500	0.00	0.00
9	9.00	6.1500	0.00	0.00
10	10.00	6.6500	0.00	0.00
11	11.00	7.2000	0.00	0.00

Rain Information

Rain file name: K:\wdp71\MINN5289.RAN  
 Rain starting date : 01/09/52  
 Rain ending date : 12/31/89

**DETPOND Output File for Proposed Minneapolis-St. Paul International Airport Wet Detention Pond (1952 – 1989)**

***Design Suggestions for In-Receiving Water Detention***

A preliminary investigation to estimate the level of stormwater control that may be possible by using the flow balancing method (EquiFlow®) at Waller Creek in Austin, TX, was conducted by Pitt (1995b). The FBM technology has been in use in Sweden for several decades for the control of stormwater (Pitt and Dunkers 1992 and 1993; and Pitt 1995). It has recently also been demonstrated in the U.S. for CSO control in New York City (Forndran, *et al.* 1991; Field and Pitt 1994a and 1994b; Field, *et al.* 1994; and Field, *et al.* 1995).

The FBM is constructed using a series of pontoons forming multiple cells in a waterbody. Weighted PVC curtains hang from the pontoons containing the stormwater that enters the FBM from the stormwater discharge location. The curtains divide the FBM into multiple cells that are interconnected by openings. In freshwater applications, the polluted stormwater moves through the FBM in plug flow, passing through successive compartments until its discharge into the receiving water.

Some FBM facilities are connected to a treatment facility on-shore for high levels of phosphate removal using ferric chloride precipitation (Pitt 1995). However, the FBM alone is capable of acting like a stormwater wet detention pond, with similar removals for particulate pollutants. New concepts for the FBM use wetland cells for increased passive removal of nutrients (Fresh Creek Technologies, West Caldwell, NJ, personal communication). The FBM can therefore be evaluated using conventional wet detention pond procedures (Pitt 1993a and 1993b).

In this example design, the maximum surface area of the FBM is limited by (1) a maximum width of 1/4 of the width of Town Lake and (2) the length is restricted by the closest upstream and downstream major stormwater outfalls from other watersheds. In addition, the FBM must be compatible with the rowing club operations near the creek outfall.

The preliminary plan is for a six cell FBM extending from a location just downstream from an existing 30 inch storm drain from the downtown area to a location just upstream from an existing 72 inch storm drain from a highway. The upper cell would capture flow from the proposed Waller Creek bypass and would then join the remainder of the Waller Creek discharge in the second cell. The creek stormwater would then flow through cells C through F before final discharge into Town Lake. The final four cells (C, D, E, and F) can be wetland cells providing additional treatment, compared to simple sedimentation. The maximum overall length of the FBM system that could be used (without accepting additional flows) is therefore about 4,000 feet, with five dividing pontoons sections, each about 300 feet long. The maximum total pontoon and curtain length would therefore be about 5,500 feet.

This FBM has a maximum surface area of about 23 acres. The depth in the FBM (at normal Town Lake levels) is as deep as about 10 feet, with an average depth assumed to be 4.25 feet. The maximum FBM volume is therefore about 100 acre-feet, or 30 million gallons. A very rough estimated turnkey cost for this FBM would be about \$1.5 to 2.0 million, including wetland planting in about 15 acres.

Cell A is adjacent to the rowing club location. This cell (and possibly cell B) would be usable as small craft areas. A short section of the outer curtain at these locations could be supported by barely submerged floats allowing small boats to pass into Town Lake. The pontoons would also provide protected small areas, about 600 feet long and about 150 feet wide. In addition, the pontoons could act as floating walkways as part of the shoreline recreational area.

The flows in Town Lake are summarized in Table 36. These worst-case flow rates were estimated from Town Lake cross sections in the Waller Creek area and from Corps of Engineers water depth and discharge data. The Town Lake cross-sectional areas have the estimated FBM cross-sectional areas subtracted. It is expected that the FBM can withstand all of these flows, with the possible exception of the 500-year event (at 13 ft/sec). In cases of excessive flows in the Colorado River through Town Lake, the FBM would rise with the lake water, with the curtains lifting off the lake bottom and ballooning towards shore, as the river currents require. The FBM would therefore have minimal affects on flood flows as the pontoons and curtains rise in the water with increasing water depths and will balance water on both sides of the curtains (*e.g.*: Flow Balancing Method).

**Table 36. Expected Town Lake Water Velocities**

Return Period	Discharge (CFS)*	Town Lake Cross-Sectional Area (ft <sup>2</sup> )	FBM Cross-Sectional Area (ft <sup>2</sup> )	Net Cross-Sectional Area (ft <sup>2</sup> )***	Velocity (ft/sec)
1-year	16,000**	6,600	640	6,000	3
10-year	38,700	9,000	1,300	8,000	5
50-year	78,650	14,000	2,700	11,000	7
100-year	102,100	16,000	3,300	13,000	8



500-year	240,000	23,000	5,200	18,000	13
----------	---------	--------	-------	--------	----

\* U.S. Army Corps of Engineers, Travis Co. FIS, March 1979.

\*\* The average of the observed instantaneous peak discharges for each year from 1981 through 1994.

\*\*\* Estimated cross-sectional area of Town lake near Waller Creek after subtracting FBM cross-sectional area.

Waller Creek flows are also of interest because they affect the force applied to the FBM curtain opposite the discharge location and the amount of water discharged determines the level of stormwater treatment obtainable. Table 37 summarizes these expected flows at the mouth of Waller Creek. The 1-year discharge may be very roughly estimated to be about 40% of the 10-year value, based on the ratio of the reported discharges in Town Lake. The high flow rates for the smaller events will likely be dissipated near the mouth of the creek, but the design of the FBM will need to consider these high flow rates.

**Table 37. Waller Creek Flows at Confluence with Town Lake**

Return Period	Discharge (CFS)*	Cross-Section Area (ft <sup>2</sup> )	Velocity (ft/sec)
10-year	5,444	500	11
25-year	7,035	1,000	7
100-year	9,424	1,625	6

\* 3-hour duration design storms for the City of Austin

The most significant factor affecting wet detention pond performance is the surface of the pond compared to the drainage area. This ratio is a surrogate for the runoff volume expected and the volume of the pond. Table 38 shows the land uses in the Waller Creek watershed and the expected annual runoff volume. Waller Creek is unusual in that the educational land use (the main campus of the University of Texas) comprises the largest flow contributor (about 32%). The single family residential area is next, at about 25%. It is expected that the 31.5 inches of rainfall at Austin falls during about 400 hours.

**Table 38. Land Uses and Annual Runoff for Waller Creek**

Land Use	Area (acres)	Estimated Annual Rv	Annual Runoff Volume (acre-ft)*	Percent of Annual Runoff
Vacant/Undeveloped	77	0.1	20	0.5
Park	127	0.1	33	0.8
Single family residential	1358	0.3	1100	25
Multiple family resid.	234	0.4	250	6
Office	247	0.5	330	8
Commercial	416	0.5	550	13
Industrial	146	0.6	230	5
Major roadways	180	0.85	400	9
Utilities	9	0.5	12	0.3
Civil/educational	866	0.6	1400	32
Water	2	1.0	6	0.1
<b>Total</b>	<b>3662</b>		<b>4300</b>	<b>100</b>

\* assuming an annual rainfall of 31.5 inches.

Table 39 shows the recommended “wet detention pond” surface area for Waller Creek for two levels of control. The 5 µm level (practically all particles having greater settling rates than 5 µm particles would be trapped) corresponds to a suspended solids control of about 90% for stormwater, while the 20 µm level corresponds to a suspended solids control level of about 65%. Table 40 shows estimated control levels for other pollutants for these two surface areas. These values do not include any additional control associated with the establishment of a wetland system within the

FBM. The use of wetland attributes can be expected to increase the removals of most of the pollutants during the active growing season. The maximum available surface area for the FBM (about 23 acres) indicates that the 20  $\mu\text{m}$  level of control may be a reasonable expectation for this proposed installation (65% control for suspended solids, 40% for COD, BOD<sub>5</sub> and phosphorus, and 60% for lead and copper, with increased control levels during the active growing season associated with the wetland cells in the FBM). A small suction dredge would have to be periodically used to remove the captured sediments from the FBM.

**Table 39. Recommended Wet Pond Surface Areas**

Land Use	5 $\mu\text{m}$ control		20 $\mu\text{m}$ control		
	Area (acres)	% of area	Area (acres)	% of area	Area (acres)
Vacant/Undeveloped	77	0.6	0.46	0.2	0.15
Park	127	0.6	0.76	0.2	0.25
Single family residential	1358	0.8	11	0.3	4.1
Multiple family resid.	234	0.8	1.9	0.3	0.7
Office	247	1.7	4.2	0.6	1.5
Commercial	416	1.7	7.1	0.6	2.5
Industrial	146	2.0	2.9	0.8	1.2
Major roadways	180	2.8	5.0	1.0	1.8
Utilities	9	1.7	0.15	0.6	0.05
Civil/educational	866	1.7	15	0.6	5.2
Water	2	0	0	0	0
<b>Total</b>	<b>3662</b>	<b>1.3</b>	<b>48</b>	<b>0.5</b>	<b>17</b>

**Table 40. Estimated Pollutant Control for Two Surface Areas**

Pollutant	5 $\mu\text{m}$ control (48 acres)	20 $\mu\text{m}$ control (17 acres)
Suspended solids	90 %	65 %
COD	50	40
BOD <sub>5</sub>	50	40
Phosphorus	50	40
Nitrate	50	40
TKN	40	25
Lead	80	60
Copper	80	60
Zinc	50	40

Another method of predicting the FBM performance is by examining settling profiles in the cells. The annual peak instantaneous flow rate through the FBM from Waller Creek is expected to be about 1.3 ft/sec (associated with a discharge of about 2200 CFS, or about 40% of the 10-year discharge rate of 5444 CFS, with an FBM cross-sectional area of about 1625 ft<sup>2</sup>). The annual average wet-weather flow rate is only expected to be about 0.1 ft/sec through the FBM cells. Table 41 shows the expected worst-case particle sizes controlled by plug flow conditions, while Table 42 shows the annual average flow particle settling conditions. The 100 ft. flow length corresponds to an area near the outfall within the first cell, while the 500 ft. flow length is approximately after the first cell. The first cell near the discharge location (either the bypass or the natural creek confluence) would therefore result in about a 70 percent suspended solids reduction for average flow conditions, degrading to about 40 percent for peak annual flows. These tables show that the use of all six cells would result in levels of control similar to the levels predicted previously using the surface area ratio values. An FBM system half as long as the six-celled unit shown here would cost much less, interfere less with Town Lake activities, and provide about 85% of the pollutant control as the full length version. It was recommended that this smaller unit be initially constructed and monitored as a demonstration facility. If the performance is as expected and additional control is desired, then the facility can be expanded.

**Table 41. Annual Peak Flow (Worst Case) Particle Settling in FBM\***

Flow Length (feet)	Travel Time (minutes)	Critical Particle Settling Rate (cm/sec)	Critical Particle Size (µm)**	Approx. Suspended Solids Control (%)
100	1.3	1.7	150	20
500	6.4	0.34	60	40
1,000	13	0.17	55	50
2,000	25	0.087	35	55
3,000	38	0.057	25	60
4,000	50	0.043	20	65

\* assuming an average FBM depth of 4.25 feet and a velocity of 1.3 ft/sec.

\*\* assuming particles have a specific gravity of 2.65 and are spherical.

**Table 42. Annual Average Flow Particle Settling in FBM\***

Flow Length (feet)	Travel Time (minutes)	Critical Particle Settling Rate (cm/sec)	Critical Particle Size (µm)**	Approx. Suspended Solids Control (%)
100	21	0.10	40	45
500	100	0.021	15	70
1,000	210	0.011	12	75
2,000	415	0.0054	7	80
3,000	620	0.0035	6	85
4,000	830	0.0026	5	90

\* assuming an average FBM depth of 4.25 feet and a velocity of 0.08 ft/sec.

\*\* assuming particles have a specific gravity of 2.65 and are spherical.

The large size of the Waller Creek watershed (and corresponding large stormwater flows) requires a large “end-of-pipe” treatment device for significant pollutant reductions. The maximum FBM that could be used at the Town Lake site would have about 23 acres of surface, equivalent to about 0.6 percent of the drainage area. This maximum sized FBM is expected to control suspended solids at the 65% level for the peak one-year flow conditions and at the 90% level for the average annual flow conditions. The first cell of the proposed six cell FBM would control at least 20% of the suspended solids associated with the annual peak flow conditions. The last four cells could have wetland attributes for much improved pollutant removals during the growing season.

**Retro-fit Examples for Providing Water Quality Benefits in Existing Dry Detention Ponds**  
***Evaluation and Recommended Modifications to a Small Dry Stormwater Detention Pond***

This example analysis, similar to the previous example for the Brook Highland Plaza pond, was also conducted by John Easton, a UAB graduate student. This example differs in that it was for a small dry detention pond at an apartment complex. The pond was evaluated in its present state, and then modifications were recommended and the hypothetically modified pond was re-evaluated. The pond is located at Stonecrest at Double Oak Mountain Apartments, in Shelby, Co., AL.

This detention pond does not meet the general requirements for a well-designed stormwater quality control practice as summarized previously. Obviously, this detention pond was designed to be a dry pond and it is purely for peak flow rate reductions. It was not intended to provide any water quality benefits. The information used in this analysis was gathered from on-site field evaluations that were limited in scope, as no engineering details were available. The contributing area was estimated at 41.4 acres (apartment complex, 26.4 ac, and uphill woodland area, 15 ac).

This analysis makes suggestions for converting this pond to a wet pond, with enhanced water quality benefits. Because of the cost associated with moving the pond or its outlet structures, the recommended changes only consider additional excavation below the outlet.

The redesign presented here will include the preferred depth of six feet, requiring excavation from 720 to 714 feet, and a minimal three foot ledge at 719 feet. The side slope will be 1:1 from 720 feet to the ledge at 719, and also 1:1 from the interior of the ledge to 714 feet. Assuming a prismatic cross-section, the additional wet storage to be constructed below the 720 feet of elevation is approximately 0.204 ac-ft.

#### Depth and Criteria

This pond is designed such that the invert of the lowest output device is level with the pond bottom. This pond is potentially hazardous as the side slopes are about 1:2. Also, this steep slope is quite long (approximately 75 feet). This apartment complex is a new development; the majority of the construction occurred in 1997. Therefore, some of the landscaping is not complete as yet. There are some shrubs and small trees planted around the perimeter, however these do not completely surround the pond or form a suitable barrier.

#### Peak Reduction Factors (PRF)

The pond only slightly reduces the peak outflow rates. The expected 100-year storm's runoff rate is reduced from 153 cfs to about 145 cfs, with a peak reduction factor of only 0.05 (corresponding to a 5% reduction of the inflow hydrograph in the pond). For the 50-year and 25-year storms, the PRFs are 0.06 and 0.07, respectively. Even in the case of the 25-yr storm, the pond exceeds the maximum stage of 633 feet and may cause frequent flooding of the frontage road. In addition, there is 13 feet of head in the pond when it is full, producing very high outflow rates, including about 60 cfs flowing in the emergency spillway. This is especially problematic because the water coming through the spillway flows directly onto Bowling Drive, and Bowling drive is curbed so the water would flow down the hill and out onto Highway 280. This would be an extremely dangerous situation because the highway has high volume, high speed traffic.

#### Upflow and Critical Settling Velocities

The water quality goal for the re-designed pond is approximately 90% total suspended solids (TSS) removal (maximum upflow velocity, or critical settling velocity) maximum of 0.00013 ft/sec). Even though the re-designed pond only provides a worst-case upflow velocity of 0.0016 ft/sec, the annual average TSS control for the 1976 typical rain year approaches 86%. The lowest TSS removal is only about 56% during this rain year.

#### Pond's Water Quality Storage

A pond's water quality storage should be equal to the runoff associated with 1-1/4" rain based on the land use of the watershed served by the pond. The composite curve number for the apartment complex was calculated to be about 87, while the woodland area had a curve number of 55. This yields a total site composite CN of 75. This 75 CN corresponds to approximately 0.40 inches of runoff for the 1-1/4 inch rain. Therefore the minimum active pond storage (between the invert elevation of the lowest outlet and the secondary outlet discharge devices) required should be a least 1.4 acre-ft. However, due to limited space, the redesigned pond's water quality storage is only 0.67 acre-ft, less than the minimum recommended area. Even though the annual average TSS removal is reasonable, the individual event TSS removals vary considerably.

Since this pond is designed to reduce extreme peak inflow discharge rates in addition to providing water quality improvement, there is an additional freeboard storage (the volume between the lowest outlet and the top of the dam) of 2.34 acre-ft in the pond.

#### Pond's Surface Area Requirements

A pond's surface area should be sized as a percent of watershed's area based on land use and the level of control desired. The Stonecrest apartment site has residential and woodland land uses. The pond surface area recommendation is about 0.33 acres, which is close to the minimum surface area of the redesigned pond (0.31 acres).

### Other Benefits

In dry weather, the redesigned pond will be available to provide water for emergency fire protection. This pond should be a pleasing amenity for the apartment residents. The use of appropriate grasses adjacent to the pond may provide a grass filter for additional pollutant reduction.

### **Background Information Related to Site Evaluation**

#### Criteria Used to Estimate Peak Flowrates

The peak inflow hydrograph values were determined by HydroCAD's SCS TR-20 methodology. For the site, a SCS Type III rainfall IDF curve was selected. Rainfall depths for the 100-year, 50-year, and 25-year storms were approximately 8.6", 7.8", and 7.1" respectively. The time of concentration for the watershed was also calculated using HydroCAD's built-in TR-20 methods;  $T_c = 24.3$  minutes for the apartment complex area, and  $T_c = 33.8$  for the woodland area.

#### Land Use, Development, Cover, Soils Type, and CNs

SCS soil maps for the Shelby County were examined, and it was determined that the Stonecrest site consisted of Nauvoo-Sunlight complex, with 15 to 25 percent slopes, and Townley silt loam, with 12 to 18 percent slopes. The SCS Hydrologic Soil Groups for these soils are type B and type C respectively. Research conducted at UAB has shown that development, due to construction disturbances, compaction, and soil mixing, can significantly reduce the actual infiltration rates from those assumed. Therefore, the curve number assigned to the developed area was for the worst case, type D soil. However, the undeveloped woodland area, mostly Nauvoo soil, was assigned a curve number based upon the type B type. Therefore for the developed area of 26.4 acres, a composite CN of 87 was assumed (based on 16 acres of residential land use with 1/8 acre lots, SCS soil type D, and 65% impervious cover, plus the remaining 10.4 acres of open lawns with good grass cover, and type D soil). A curve number of 55 was assumed for the woodland area of 15 acres, corresponding to woods with good hydrologic condition and type B soils.

### **Analysis of Design Storms**

#### HydroCAD™

The HydroCAD Stormwater Modeling System (version 4.53) was used to analyze the pond for flow behavior during large design storms. The program does not consider the dead storage below the first outlet, assuming that this is always full of water, therefore the hydraulic behaviors of both the existing pond and the redesigned pond are identical.

The subcatchment component of HydroCAD was used to model the two subcatchments: subcatchment 1 refers to the 26.4 acres of the apartment complex, and subcatchment 2 consists of the 15 acres of woodland area that drains to the complex. This data, as input to the model, is described in Figure 65 and Table 43.

Elevation v. Surface Area  
Stonecrest Dry Detention Pond

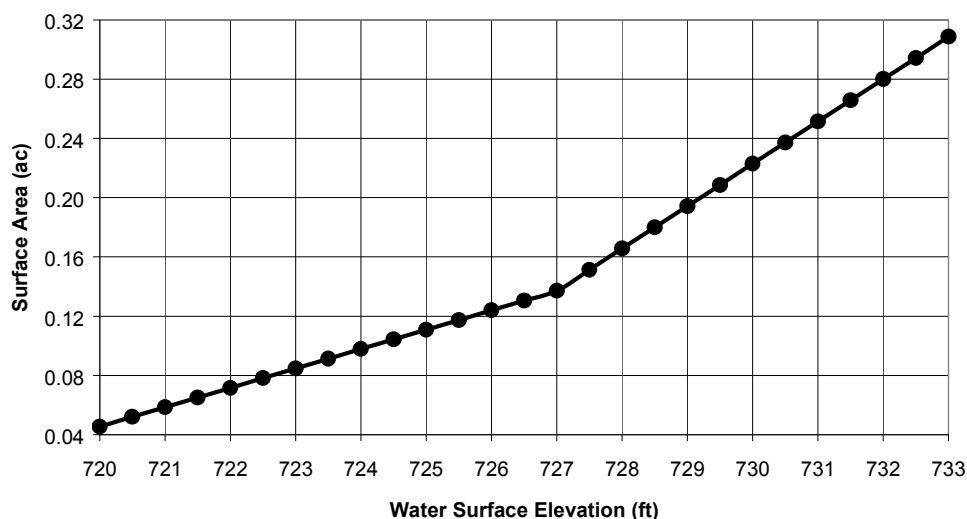

Figure 65. Stage v. Surface Area Curve.

Table 43. Outlet Device Descriptions

#	Route	Invert	Outlet Devices
1	primary	720'	<b>24" culvert</b> n=0.013, length=185', slope=0.02 '/, Ke=0.5, Cc=0.9
2	to #1	720'	<b>12" orifice</b>
3	to #1	727'	<b>sharp-crested rectangular weir</b> length=12', height=8" (square concrete box with cap)
4	secondary	732'	<b>10' broad-crested rectangular weir</b> emergency spillway

The HydroCAD simulations were made for three SCS type III design storm frequencies: 25-year (7.1"), 50-year (7.8"), and 100-year (8.6"). Table 44 summarizes the model's output for these three storms, showing the hydrographs peaks and volumes. The most significant contribution to the hydrograph flowing into the pond comes from the apartment complex area, as expected.

Table 44. Subcatchment Summaries for Design Storms

Subcat #	description	Design Storm Frequency	Rainfall (in)	Peak (cfs)	Volume (ac-ft)
1	apartment complex	25-yr	7.1	102.6	10.79
2	woodland	25-yr	7.1	19.13	2.46
1	apartment complex	50-yr	7.8	114.4	12.04
2	woodland	50-yr	7.8	23.59	2.99
1	apartment complex	100-yr	8.6	127.9	13.47
2	woodland	100-yr	8.6	28.94	3.64

Table 45 summarizes the pond routing calculations. As previously noted, the peak reductions are quite low (5-7%), and the peak discharge lag is only 5 to 10 minutes. The peak elevation in the pond is higher than the maximum elevation in the pond, 733 ft. This is a dangerous situation because it means that the water is flowing uncontrollably over the dam. This could damage the emergency spill way and cause erosion of the dam itself. Notice that these

events occur even at the lowest storm frequency modeled, 25-yr. It would appear that the pond is inadequate for the amount of runoff generated by these storms.

Replacing the secondary outlet with one that is less restrictive could mitigate the danger of overflowing the pond's dam. This would also probably require enlarging the 24" culvert that flows under Bowling Drive, and would worsen already poor peak flow reduction characteristics of the pond. However, this would decrease the frequency in which water reaches the emergency spillway, flows out onto Bowling Drive and continues down the hill onto Highway 280. It is interesting to note that a similar detention pond recently constructed several miles away at a new shopping center failed, releasing large quantities of water onto Highway 280.

**Table 45. Pond Results of HydroCAD simulations**

Design Event	Rain Depth (in)*	Peak Elev. (ft)**	Peak Storage (ac-ft)	Peak Qin (cfs)	Peak Qout (cfs)	Peak Qoutlet† (cfs)	Peak Qemer‡ (cfs)	Atten. (%)	Lag (min)
25-year	7.1	733.4	2.11	118.30	110.20	50.51	59.73	7	8.1
50-year	7.8	733.8	2.21	134.20	126.10	51.00	75.15	6	7.2
100-year	8.6	734.1	2.31	152.60	144.90	51.59	93.36	5	5.8

\* Design storms are type III 24-hr for Shelby County (SCS methods).

\*\* Flood elevation is at 633 feet.

† Peak flow through the first and second outlets to 24" culvert.

‡ Peak flow in the emergency spillway (flowing onto Bowling Drive).

#### DETPOND

As in the previous example, the 25-year, 50-year, and 100-year hydrographs generated using HydroCAD's TR-20 methods were used in DETPOND to estimate the TSS removals during these large rains. A comparison of the hydraulic results from HydroCAD with the DETPOND results in Table 46 indicates similar values. Even under these severe conditions, the pond is removing approximately 50% of the TSS.

**Table 46. DETPOND Summary for Design Storms**

Storm Year	Max. Stage (ft.)	Max. Inflow (cfs)	Max. Outflow (cfs)	Max particle size discharged (µm)	Avg. Min Particle Size Controlled (µm)	% TSS Removed
25	733.46	118.0	100.1	95.0	26.5	50.8
50	733.96	134.2	118.0	95.0	28.1	48.6
100	734.48	152.6	136.6	95.0	29.7	46.7

#### **Analysis Using Actual Long-Term Rainfall Records**

##### DETPOND

DETPOND simulations were conducted using rain files created from the 1976 Birmingham monitoring data, and also the 1952 through 1989 rain record. There are 23 events, out of a total of 4,107 in the Bham5289 file, in which the pond stage rises to the level of the second outlet. Water quality evaluations in the existing dry pond were not conducted as they are assumed to be negligible.

**Short-term simulations using Bham76.** The results of the simulations using the Bham76 file are presented in Table 47. On average, in a typical year, the pond will collect particle sizes 4 µm and greater in size, which represents approximately 86% TSS control. This re-designed pond only contains runoff from a 0.5 inch rain, far short of the preferred 1-1/4 inch rain recommendation. Even though the average control is a desirable 86%, the worst-case removals are much less.

**Table 47. Water Quality Output Summary for 1976 Rain File**

Statistic	Rain Depth (in)	Rain Duration (hrs)	Intvert Duration (days)	Rain Intensity (in/hr)	Max Pond Stage (ft)	Flow-weighted Particle Size	Approx. Part. Res. Control* (%)	Peak Reduction Factor	Event Flushing Ratio
Mean	0.50	12.01	1.81	0.04	6.30	4.26	86	0.07	1.75
Std. Dv.	0.75	10.77	2.36	0.06	0.51	4.23	13	0.07	2.41
COV	1.51	0.90	1.30	1.48	0.08	0.99	0.16	1.00	1.37
Min.	0.01	1.00	0.00	0.00	6.00	0.00	57	0.01	0.00
Max.	3.84	45	11.68	0.31	8.84	15.70	100	0.31	9.34

\* Approximate Particle Residue Control (TSS).

Figure 66 shows the maximum pond stage, axis labels denote the elevation above the pond bottom (6' corresponds to 720' msl elevation, the invert of the first outlet device) versus the percent particle control. There is an expected trend, the TSS control decreases with maximum stage, i.e., more water flowing into the pond.

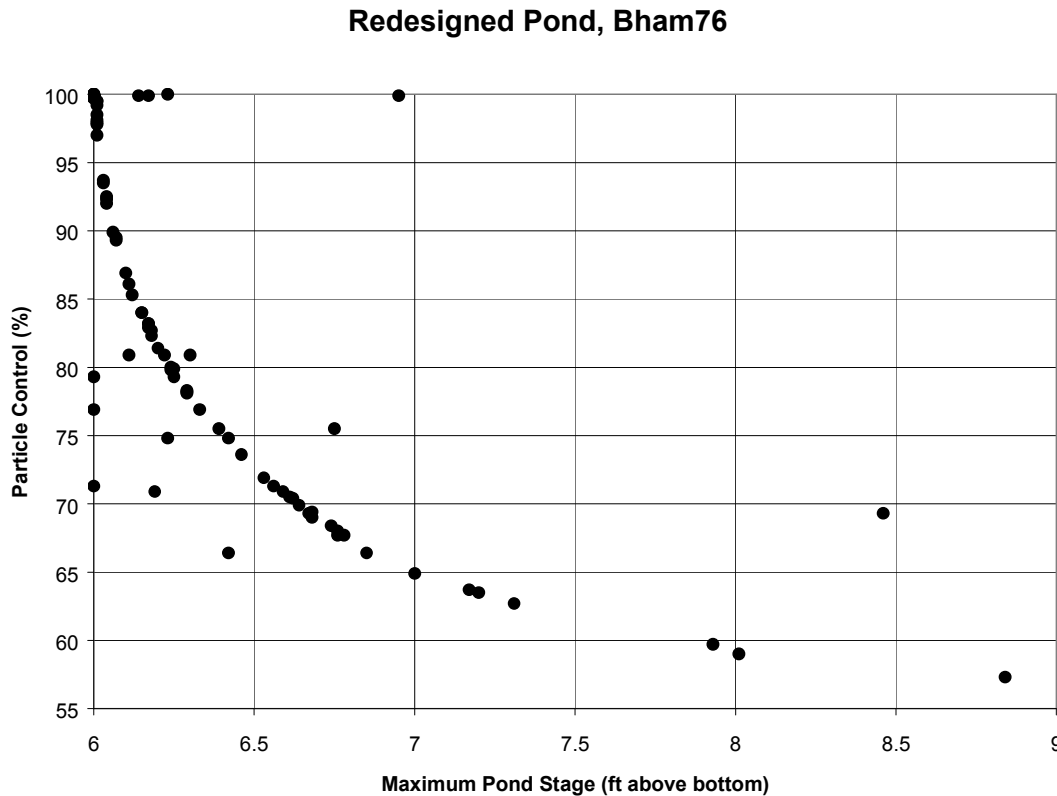

**Figure 66. Pond Stage v. Particle Residue Control**

Figure 67 shows the water quality performance of the redesigned pond (% particulate control) versus the rain depth in inches and Figure 68 shows water quality performance versus rain intensity. Generally, percent TSS control decreases as the rain depth, or the rain intensity, increase, as expected.



### Redesigned Pond, Bham76

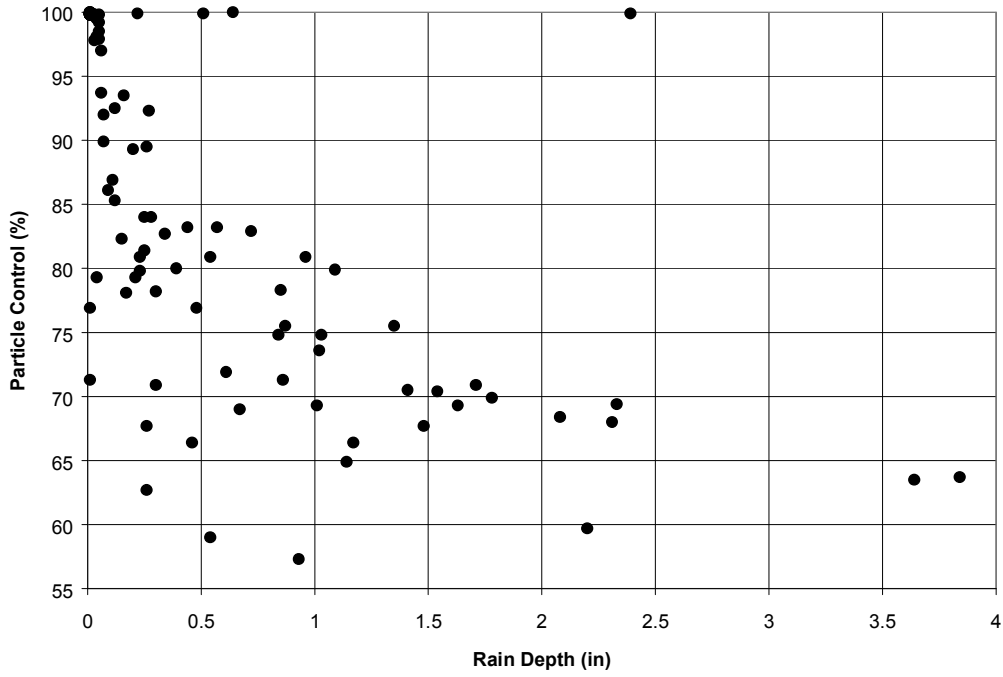
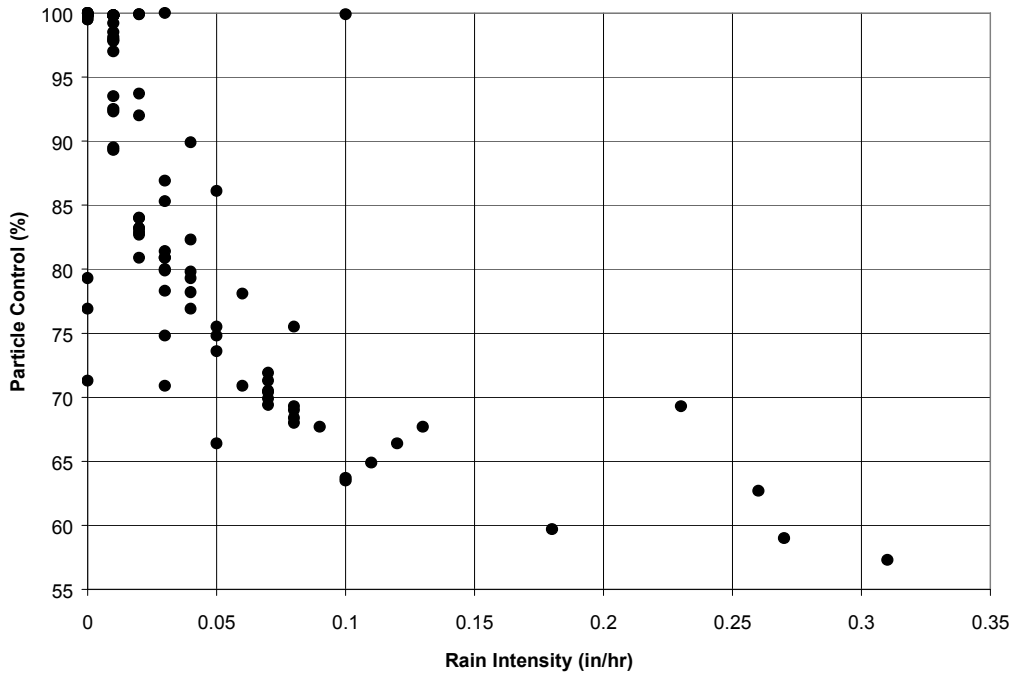

Figure 67. Rain Depth v. Particle Residue Control

### Redesigned Pond, Bham76



**Figure 68. Rain Intensity v. Particle Residue Control**

**Long-term Simulation using Birmingham Rain, 1952-1989.** Table 48 contains DETPOND analysis summaries for the 4,107 rain events that occurred in Birmingham from 1952-1989. With close to forty years of rains, the redesigned pond still averages 80% TSS removal.

**Table 48. Water Quality Output Summary for 1952-1989 Rain File**

Statistic	Rain Depth (in)	Rain Duration (hrs)	Intervt Duration (days)	Rain Intensity (in/hr)	Max Pond Stage (ft)	Flow-weighted Particle Size	Approx. Part. Res. Control* (%)	Peak Reduction Factor	Event Flushing Ratio
Mean	0.50	6.31	2.57	0.09	6.65	6.43	80	0.13	1.91
Std. Dv.	0.75	6.88	3.54	0.11	1.06	4.91	14	0.10	2.44
COV	1.50	1.09	1.38	1.31	0.16	0.76	0.18	0.76	1.28
Min.	0.01	1.00	0.00	0.00	6.00	0.20	48	0.00	0.00
Max.	13.58	93	44.31	1.45	13.73	23.2	100	0.57	9.96

\* Approximate Particle Residue Control (TSS).

**Design Storm Runs Using DETPOND**

The pond inflow hydrograph from the HydroCAD runs was used as a “user defined hydrograph” for input into DETPOND to evaluate the water quality control during these low frequency design storms. The following is the output from DETPOND for the 25-year design storm:

**25-year Design Event**

```

* This pond stage elevation is higher than the highest control outlet structure (el: 19 ft).
The pond bank is overtopped - increase the size of the emergency spillway.
This stage value assumes outflow is constant and equal to the highest value on the rating curve.
Time increment (min)= 6      Number of increments= 363
Rain depth (in) (N/A for user defined inlet hydrograph): 0.00
Rain duration (days): 0.42      Event duration (days): 0.51
Interevent duration (days): 0.00      Inflow rate to pond (cfs): max= 118.3
Outflow rate from pond (cfs): min= 0.0      max= 100.1      time weighted ave= 4.4
Net inflow volume (cu ft) - event: 8168      cumulative: 8168
Total inflow volume to pond (cu ft): 576684
Outflow volumes (cu ft) - hydraulic: 568516
                          - seepage: 0
                          - evaporation: 0
                          - total outflow: 568516
Pond storage above lowest invert (cu ft): max = 93000
Pond storage below lowest invert (cu ft): 8168
Pond stage above datum for event (ft): min= 1.21      max= 19.46
Pond surface area for event (sq ft): min= 1307      max= 14102
Event flushing ratio (total inflow volume/pond storage below invert): 70.61
Upflow velocity for event (ft/hr): min= 0.000      max= 25.547
Minimum particle size controlled (microns): flow weighted average= 26.5
Particulate solids control (percent): min= 35.8      flow weighted average= 45.8
Peak Reduction Factor (PRF): 0.15
*** The largest ave particle size discharged during any time increment: 38.7 microns

```

Particle Size Distribution

Percent of Particles Larger than Size Indicated	Pond Inflow During Event	Theoretical ***	Particle Size n=8	Particle Size n=3	Particle Size n=1	Particle Size n=1	Particle Size n=1	Particle Size n=1	Particle Size n=1
0 >	2000.0	26.5	95.0	95.0	233.3	95.0	95.0	95.0	95.0
10 >	233.3	20.1	22.2	25.0	32.1	23.0	23.0	23.0	23.0
20 >	95.0	16.0	15.8	16.9	20.3	16.1	16.1	16.1	16.1
30 >	53.3	12.6	11.9	12.4	14.4	12.0	12.0	12.0	12.0
40 >	32.5	10.1	9.2	9.7	11.0	9.3	9.3	9.3	9.3
50 >	21.0	8.0	7.4	7.6	8.4	7.4	7.4	7.4	7.4

60	>	13.5	6.2	5.6	5.8	6.4	5.7
70	>	9.0	4.7	4.3	4.4	4.7	4.3
80	>	5.7	3.2	2.9	3.0	3.2	2.9
90	>	3.0	1.6	1.5	1.5	1.6	1.5
100	>	0.0	0.0	0.0	0.0	0.0	0.0
Row A:			38.7	95.0	95.0	233.3	95.0
Row B:			26.5				
Row C:			45.8	51.2	49.9	45.7	50.8

Row A: Largest ave particle size discharged (microns) during any time event  
Row B: Flow weighted average minimum particle size controlled (microns)  
Row C: Percent particulate solids removed

**Photographs of the Dry Detention Pond at the Stonecrest Apartments**  
Emergency spillway flowing directly onto Bowling Drive.



Facing north, from left to right: emergency spillway, secondary outlet, primary outlet, large inlet.



Facing North, dam.



### ***Retrofit of Dry Detention Pond in Sunnyvale, CA***

South San Francisco Bay has a serious heavy metal problem, especially for copper, and numerous methods are being investigated to reduce the discharges of metals. Woodward Clyde Consultants (1994) conducted a retrofit project for the Santa Clara Valley Nonpoint Source Pollution Control Program to demonstrate the benefits of modifying an existing dry detention pond for enhanced water quality benefits. The discussion in this section is mostly taken from that report.

According to an inventory conducted by Woodward-Clyde (1990), there are 17 municipally-owned and operated pump stations in Santa Clara Valley. These pump stations generally consist of pumps, storage units such as a sump or a detention basin, and inlet and outlet works. Sumps and detention basins are designed to reduce the capacity of the pumps that would otherwise be needed to pass the peak flood flows. The purpose of the pump stations is to provide flood protection to low lying areas which have historically subsided and are now protected by levees. These pump stations have generally been operated as single-purpose flood control facilities. The pump operating schedules are designed such that the pumps go on as soon as water begins to fill the basin with the goal of emptying the basin as soon as possible after the event. One retrofitting option to achieve water quality benefits would be to change the pump operating schedule in order to increase detention time and to provide for a seasonal wet pond. A preliminary evaluation of retrofitting detention basins was encouraging and a pilot study to actually retrofit a facility and conduct testing to measure water quality benefits and costs was conducted. This study was conducted from August 1990 through July 1993.

The following tasks were conducted as part of this study:

- Retrofit the pump station and modify pump schedules to improve storm water pollutant removal,
- Conduct water quality sampling to estimate the pollutant removal effectiveness of the retrofitted detention basin, and
- Measure sediment concentrations in the basin in order to evaluate if sediments are classified as hazardous waste.

The detention basin has a channel between the inlet and outlet that, prior to the modifications, encouraged short-circuiting. A gabion weir was installed at the outlet to reduce short circuiting and to provide better distribution of flow into the outlet. Rock was dumped into the channel leading from the inlet, and a drainage pipe that ran below the channel was blocked off. Operational changes consisted of modifying the pump schedule to create a two-foot permanent pool at the outlet and to provide temporary storage and slow release of water over the depth range of 2 to 2.4 feet.

#### **Site Description**

The northern portion of Santa Clara Valley has a history of subsidence caused by groundwater pumping. In order to protect these areas from flooding, a system of levees and pump stations has been built. The pump stations are designed to collect and pump storm water runoff from these low lying areas through the levees into the flood control channels. In order to accommodate large flows and to reduce the number and pumping capacity of the pumps, some pump stations include relatively large sumps or detention basins. An inventory of the pump stations indicates that there are nine such facilities in the Valley with relatively large detention basins (WCC 1990). The design and operating philosophy of these systems is to: 1) attenuate the peak flow to reduce pump size, and 2) drain the basins as soon as possible following the storm so that flood capacity is available for subsequent storms.

An example of one of these pump stations is Sunnyvale Pump Station No. 2, located at the junction of the Milpitas/Alviso Road (Route 237) and Calabazas Creek. The Pump Station consists of four primary pumps, each rated at 39 cfs capacity, and one auxiliary electric pump (capacity 9 cfs). The detention basin area is approximately 4.4 acres and has a capacity of approximately 30 acre-feet (Figure 69). It receives runoff from a 463-acre catchment consisting of the following land uses: industrial park (30 percent), commercial (10 percent), and residential (60 percent). There is a seven-foot diameter concrete reinforced pipe which drains into the basin. A second 36-inch

diameter line drains a 250 acre catchment (primarily open space) and bypasses the basin to the north and directly enters the pump house.

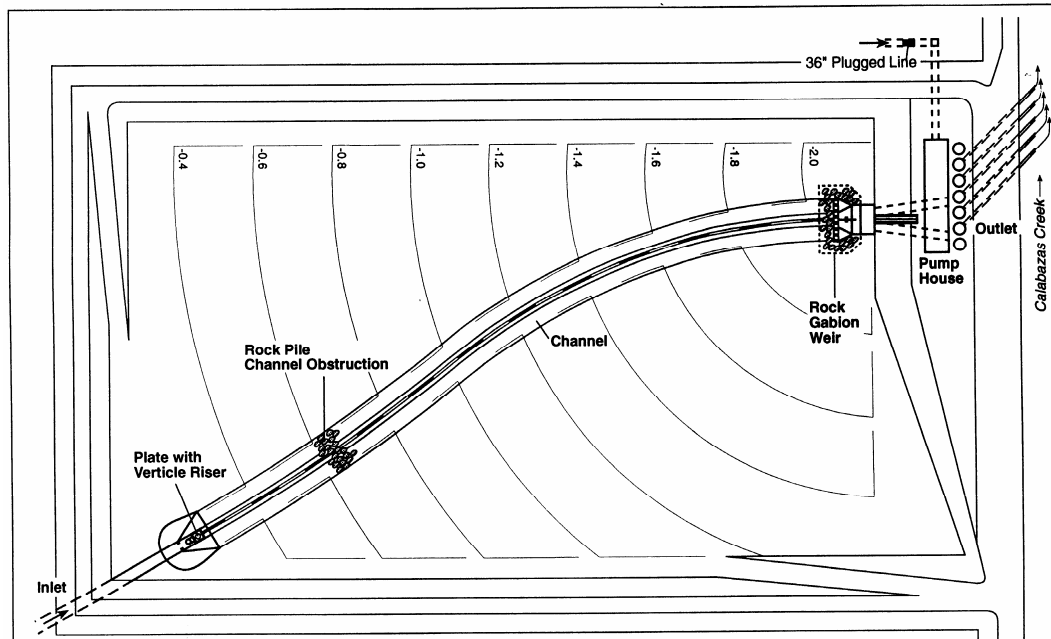

Figure 69. Sunnyvale Pump Station No. 2 dry detention pond.

#### Treatment Concepts and Retrofitting Objectives

The major premise for this project was that pump stations may provide an opportunity to reduce nonpoint source loads entering the South Bay if they can be cost-effectively retrofitted and maintained. The primary means of treatment is settling of particulates. Settling can be an effective treatment for some pollutants that are mostly in the particulate fraction in stormwater. Typical ranges of the particulate fraction for locally collected stormwater are 36 to 94 percent (mean of 69 percent) for copper and 24 to 97 percent (mean of 66 percent) for lead. Because of these high particulate fractions, sedimentation could be an effective control practice.

The retrofitting scheme is to increase the detention time to allow more particulates to settle out into the basin while not significantly increasing the flood risk. A goal of this retrofit was to prevent high flows from resuspending previously settled sediments in the detention pond. Scour protection was provided by having at least a two foot permanent wet pool during the wet weather season.

They concluded that a 24 to 40 hour hydraulic detention time for a pool several feet deep was necessary to effectively settle out most of the suspended sediment in the local stormwater.

In all cases, the basin must maintain a relatively large flood control capacity and associated outlet works and pumps in order to provide the necessary flood control benefits.

#### Description of Sunnyvale Retrofit Activities

**Change Pump Operational Rules to Create a Permanent Pool and Temporary Storage.** In order to create the permanent pool in the pond, the pumps were set to turn off when water levels in the basin (as measured at the outlet) dropped below two feet. In order to create temporary storage, pump settings were adjusted to phase in (and out) very slowly for depths between 2 and 2.4 feet. These operational conditions created a temporary storage depth above the permanent pool of 0.4 feet with a capacity of 1.75 acre feet. Because this is an existing flood control facility, the temporary storage depth was determined primarily based on flood control and secondarily on water quality

considerations. The temporary storage depth was the maximum depth that would still allow the basin to pass the 100 year flood.

***Prevent Short Circuiting.*** The pond has a trapezoidal open pilot channel (8-foot bottom width, 17-foot top width, and 4.5-foot depth) between the inlet and outlet (Figure 69). In addition to this open channel, a 30-inch reinforced concrete pipe (RCP) was below the channel to convey low flows between the inlet and outlet. These conveyances effectively “short circuited” flows between the inlet and outlet, a condition which is highly unsuitable for water quality control.

In order to limit this short circuiting, three modifications were made. At the outlet weir near the pump house, a gabion wall was constructed around the original outlet weir to prevent short circuiting of flows along the channel and to also promote a better distribution of flow from the basin into the outlet weir. A second modification involved placing rock into the channel near the inlet. The third modification involved covering the entrance of the 30-inch RCP with a steel plate and vertical riser that reduced the rate at which flow would enter the drain below the trapezoidal channel.

***Plug Storm Drain that Directly Entered Pump House.*** A 36-inch RCP drained a 250-acre undeveloped area west of the detention basin directly to the pump house sump. This pipe was plugged with sand bags in one of the manholes upstream of the sump to prevent the runoff from this drainage area to mix with outflow from the detention basin in the sample collection area.

#### **Problems Encountered**

No problems were encountered during the structural retrofitting of the detention basin. However, the pump control system needed major repairs in order to operate the basin within the water level tolerances required for the study. Specific problems were encountered with the liquid level sensors and transmitter (inaccurate flow monitoring because of the very low flow rates), voltage instabilities caused when certain pumps came on line, and fluctuations in the power supply. Therefore, an important aspect in evaluating the feasibility of retrofitting pump stations is the design and condition of the pump control system and the possible need for repairs and upgrading.

#### **Monitoring Program**

The goal of this study was to measure the total runoff and collect flow-weighted composite water samples at both the inlet and outlet of the detention basin during and after storms in order to estimate pollutant removal performance. Sediment samples were also taken to characterize basin sediments.

***Station Design and Equipment.*** Automated flow and water quality monitoring stations were located at the inlet and the outlet to the basin. The inlet pipe was a 7-foot diameter reinforced concrete pipe which was quite low and tended to be full of water during most of the wet weather season. The inlet sampling station was located 35 feet upstream of the end of the pipe and consisted of a Druck pressure transducer, velocity meter, ISCO Model 3700 automatic water quality sampler and Campbell Scientific CR-10 data logger/controller. At the inlet, the initial plan was to collect flow-weighted composite samples based on flow volumes estimated using the measured velocity times the area of the pipe. Initially, a Montadero-Whitney electromagnetic velocity meter was used. However, the velocities in the pipe were too low to measure with this instrument and it was replaced in March, 1992 by a Detectonics I.S. Surveylogger, which relies on the doppler effect and suspended sediment passing the instrument. When compared with estimates of anticipated runoff volumes, neither instrument appears to have measured flow velocities in a consistent and accurate manner. The primary cause appears to be the relatively low velocities in the large pipe.

The outlet sampling was conducted in the pump house where a Druck pressure transducer, an ISCO Model 2700 automatic sampler, and CR-10 datalogger/controller were installed. The initial plan was to start sampling based on estimated flow through the pumps. These estimates were based on the pump run times and pump characteristic curves (which show the relationship between flow and head for the design rpm of 700). To achieve this, the datalogger was connected to the pump house control panel to determine pump run times and calculate discharge from the sump. Field visits during the 1991-92 season revealed that the pumps did not operate at the design rpm, especially during the warm-up period, resulting in inaccurate flow estimates much of the time.

**Sampling Methods.** At the inlet, a pressure sensor was used to estimate the water level in the detention basin. During each sampling event, flow was calculated as a product of velocity and area by the CR-10 microprocessor. Based on the flow estimate (which was generally poor), the CR-10 initiated and continued water quality sampling at pre-specified flow intervals. During a sampling event, instantaneous velocity and pressure were recorded each time a water quality sample was taken. Based on anticipated rainfall, the sampling algorithm in the CR-10 was designed to instruct the water quality sampler to collect twenty 500-mL subsamples in a 10L borosilicate bottle over the duration of the storm event. Following the sampling event, the pressure sensor was also used to measure water level drops in the pond.

At the outlet, the average hourly flowrate was estimated based on the pump run times and the pump characteristic curves (also inaccurate), and was recorded over the duration of the wet weather season. To begin an event, field crews manually initiated the automated samplers based on anticipated flow volumes for that storm. As with the inlet, the automated samplers recorded instantaneous flow measurements when each sample was collected.

Stations were visited prior to, during, and after monitored events to ice samples, exchange sample bottles, and ensure proper equipment operation. Measurements of pH, conductivity, and temperature were made during the site visits.

**Data Collected.** A total of eight storm events were sampled. For six of these events, flow-weighted composite water quality samples and hydrologic measurements were taken at both inlet and outlet stations. In most cases, only partial flow measurements were made because of either equipment malfunction, below threshold velocities, and/or problems with the pump control system.

Due to the uncertainty in flow volume measurements, pollutant loads were not used to estimate treatment effectiveness. Instead, effectiveness was estimated based on the flow composite water quality concentration data, using the reasonable assumption that the inlet and outlet volumes for an event are equal.

Sediment samples were taken at three locations: in the center of the basin, near the inlet, and near the outlet. Three sets of sediment samples were collected during dry periods when the basin was empty, or nearly empty, of water (June 15, 1990, May 14, 1992, and on July 12, 1993). The first samples were obtained using a 4-inch stainless steel hand auger, while the other samples were collected by scraping the top half-inch of sediment with a Teflon™-lined scraper.

### **Flooding Analysis, Storm Hydrology, Water Quality and Sediment Monitoring Results**

**Flooding Analysis.** Woodward Clyde used a reservoir routing model to estimate water levels in the basin for the 100-year inflow event and for two pump operating scenarios. The first pumping scenario corresponded to the original pumping schedule used for flood control. The second scenario corresponded to the revised pumping schedule appropriate for a multipurpose flood control and water quality control facility. Based on the results of the model, the maximum water level in the basin for the 100-year flood did not change by modifying the pump operation schedule.

**Precipitation.** Rainfall was measured with a tipping bucket rain gage, which registered the time when the bucket collected 0.1 inches of rainfall. The range of storm volumes during the sampling period were from 0.4 to 2.2 inches and the storm durations ranged from 6 to 60 hours. Historical rainfall data collected by the National Weather Service at the San Jose Airport (Gage No. 7821) was used to examine the long period characteristics of the local rainfall by using the Synoptic Rainfall Analysis Program (SYNOP). The median event rainfall volume for the San Jose Airport gage for the period from 1948 to 1989 was 0.5 inches.

**Runoff.** Flow measurements collected at the inlet and outlet for various events were compared with rainfall to calculate the volumetric runoff coefficients. The flow measurements at both the inlet and outlet stations were not considered very reliable, as the measured runoff coefficients ranged from 0.1 to 1.89. Woodward Clyde estimated that the actual values would be about 0.5-0.8 for these rains and watershed characteristics.



**Comparison of Inlet Water Quality to Other Santa Clara Storm Water Monitoring Station Data.** Laboratory chemical analyses were conducted on the water samples collected at the basin inlet and outlet stations during the six storm events. The median flow-weighted composite concentrations of total metals (cadmium, chromium, copper, lead, nickel, and zinc) from the inlet station are summarized in Table 49. The table shows median concentrations obtained from other Santa Clara Valley storm water monitoring stations representing residential-commercial, industrial, and open land uses. The inlet concentrations of copper, lead, nickel, and zinc are higher than concentrations from open land use, but lower than concentrations at residential-commercial and industrial land use stations. The cadmium concentration appears to be very similar to the residential-commercial land use, while the chromium concentration is closer to the open land use.

**Table 49. Comparison of Median Metal Concentrations at Inlet to Retrofitted Basin to other Santa Clara Valley Stormwater Monitoring Station Data (µg/L)**

	Inlet to Retrofit Basin (n=6)	Residential/ Commercial Land Use Station (n=21)	Industrial Land Use Station (n=25)	Open Space Land Use Station (n=4)
Cadmium	1.1	1.0	3.9	0.3
Chromium	12	16	24	11
Copper	24	33	51	11
Lead	38	45	91	2.0
Nickel	21	30	46	5.0
Zinc	180	240	1150	5.0

**Pollutant Removal Effectiveness.** Table 50 summarizes inlet and outlet concentrations for total and dissolved metals (cadmium, chromium, copper, lead, nickel, and zinc), TSS, hardness and total oil and grease. Based on these data, pollutant reductions were estimated as the outlet minus inlet concentration divided by the inlet concentration. The average pollutant removal effectiveness for the metals ranged from about 30 to 50 percent. The metals removal data indicated that the removal of total chromium, copper, lead, nickel and zinc were well correlated with TSS removal.

**Table 50. Inlet and Outlet Observed Concentrations and Pollutant Removals**

	Cadmium (µg/L)		Chromium (µg/L)		Copper (µg/L)		Lead (µg/L)		Nickel (µg/L)		Zinc (µg/L)		TSS (mg/L)	TH (mg/L)	O&G (mg/L)
	nf	f	nf	f	nf	f	nf	f	nf	f	nf	f			
<b>SE 17</b>															
Inlet	0.4	<0.2	3.6	1.8	8.7	5.4	6.4	2.2	1.7	<2	46	28	120	97	1.5
Outlet	0.2	<0.2	2.7	1.1	6.8	4.7	3.4	1	1.7	<2	26	19	73	120	1.4
Reduction	--	--	25%	--	22%	--	47%	--	0%	--	43%	--	39%	--	7%
<b>SE 20</b>															
Inlet	6.6	1.3	12	1	24	3	45	1	16	1	180	19	90	110	0.2
Outlet	4.8	2.5	6	1	9	3	10	1	4	1	73	22	24	63	<0.2
Reduction	--	--	50%	--	63%	--	78%	--	75%	--	59%	--	73%	--	--
<b>SE 21b</b>															
Inlet	1.1	0.2	18	1	24	2	53	<1	25	<1	180	5	140	--	--
Outlet	1.5	<0.2	14	1	16	2	35	<1	19	<1	120	7	93	--	--
Reduction	--	--	22%	--	33%	--	34%	--	24%	--	33%	--	34%	--	--
<b>SE 23</b>															
Inlet	1	0.2	11	<1	27	5	30	1	13	3.9	190	41	74	100	0.7
Outlet	0.6	<0.2	8.3	1.4	12	4.7	12	<1	5.8	2.2	82	45	31	90	0.5
Reduction	--	--	25%	--	56%	--	60%	--	55%	--	57%	--	58%	--	--
<b>SE 24</b>															
Inlet	1.6	<0.2	21	1.1	40	2.1	76	<1	42	9.6	270	22	180	140	0.6
Outlet	1.3	0.2	15	8.6	24	5	40	1.4	29	15	160	31	96	140	3.5
Reduction	--	--	29%	--	40%	--	47%	--	31%	--	41%	--	47%	--	--
<b>SE 27</b>															
Inlet	1	0.5	6.3	1.4	14	5.4	13	<1	83	63	70	35	30	110	1.6
Outlet	0.6	0.4	4.9	1.7	8.9	4.5	6.6	<1	25	20	47	26	15	220	1.3

Reduction	--	--	22%	--	36%	--	49%	--	70%	--	33%	--	50%	--	--
<b>Average Reduction</b>	--	--	29%	--	42%	--	53%	--	51%	--	44%	--	50%	--	--

nf: non-filtered (total)  
f: filtered ("dissolved")

TSS: total suspended solids  
TH: total hardness, as CaCO<sub>3</sub>

O&G: oil and grease  
removals are only given if most observations were >PQL

**Comparison to Water Quality Objectives (WQOs).** Of these metals, total and dissolved chromium, lead and nickel did not exceed the acute WQOs. Total and dissolved cadmium exceeded the WQO in only one storm out of six monitored storms. Total copper at the inlet station exceeded WQOs in four out of six storm events. However, concentrations at the outlet station never exceeded WQOs (though the outlet concentration was essentially equal to the WQO for one event). None of the dissolved copper concentrations exceeded the acute WQOs. Total zinc concentrations at the inlet and outlet stations exceeded the acute WQOs for all six storms. Dissolved concentrations of zinc at the outlet station exceeded the WQOs in three of the six events.

**Sediment Quality.** The objectives of the sediment sampling was to characterize sediment quality in the detention basin and to compare the sediment concentrations to hazardous waste criteria. Results of these sediment samples are summarized in Table 51.

**Table 51. Sediment Observations (mg/kg)**

	% TOC	Cadmium	Chromium	Copper	Iron	Lead	Manganese	Nickel	Zinc
<b>6/15/90 core</b>	--	2.2	--	92	--	36	--	61	320
<b>5/14/92 surface</b>									
Inlet	3.8	23	200	150	49,000	280	610	94	750
Middle	5.5	17	220	140	38,600	350	640	87	570
Outlet	1.9	35	140	47	47,700	18	680	76	260
<b>7/12/93 surface</b>									
Inlet	2.4	1.0	170	110	34,000	260	560	96	220
Middle	0.65	0.2	120	37	36,000	12	700	75	85
Outlet	0.93	0.3	110	43	30,000	24	570	73	63
<b>TTLc</b>		100	2,500	2,500	--	1,000	--	2,000	5,000

TTLc: Total Threshold Limit Concentration

In the second and third rounds of sampling, the highest concentrations for copper, nickel and zinc were found at the inlet station. Cadmium, chromium and lead were also highest at the inlet station for the July 12, 1993 sampling round. The high concentration of the majority of the metals near the inlet is consistent with other studies.

Average sediment concentrations observed in Pump Station No. 2 are compared in Table 52 with sediment data collected from other detention basins in the Valley and elsewhere. Results from the various basins differ substantially and indicate that sediment quality is highly site specific and varies depending on soils, catchment land use, and other factors, especially time when the samples were analyzed (for lead).

**Table 52. Comparison of Average Sediment Concentrations from Detention Basins and Swales (mg/kg)**

Detention Basin	Cadmium	Copper	Nickel	Lead	Zinc
<b>This Retrofit Basin</b>	<b>11.2</b>	<b>88</b>	<b>80</b>	<b>140</b>	<b>324</b>
<b>Other Santa Clara County</b>					
Eastside Basin A	0.37	32	36	17	68
Eastside Basin B	0.37	36	40	6	73
Eastside Basin C	1	71	100	11	330
River Oaks	nd	24	72	14	84
<b>Fresno NURP</b>					
Recharge F	--	37	32	713	--
Recharge G	--	25	37	487	--
Recharge M	--	55	53	1333	--

Recharge EE	--	25	22	297	--
Recharge MM	--	9.5	11	93	--
<b>Wigington (1983)</b>					
Bulk Mail Basin	2.8	19	--	112	224
Kmart Basin	0.8	13	--	368	114
<b>Nightingale (1975)</b>					
Detention Basin	--	20	--	224	107
Special Pit	--	23	--	801	236
<b>Wigington (1986)</b>					
Fairidge Swales	0.26	4.2	--	42	102
Stratton Woods Swales	0.18	10	--	18	70
Rte. 234 Rd. Swales	0.82	23	--	936	106

To evaluate whether the sediments were hazardous, concentrations were, compared to standards established in the California Administrative Code, Title 22. Under Title 22, there are two criteria for designating solids as hazardous waste. The first criterion is that the sediment concentrations not exceed the Total Threshold Limit Concentrations (TTLC). The second criterion is that the extract obtained from the WET extraction method not exceed the Soluble Threshold Limit Concentrations (STLC). For this pilot scale screening level of analysis, it was considered adequate to compare with the TTLC only. In situations where disposal is being considered, the WET extraction test should also be conducted.

None of the sediment sample concentrations collected in the Sunnyvale Pump Station basin exceeded the TTLC. The highest concentrations of cadmium, lead, and zinc were 4, 3, and 7 times lower than the TTLC, respectively. The highest concentrations reported for chromium, copper, and nickel were 11, 17 and 21 times lower than the TTLC, respectively. Based on these sediment concentrations, these sediments are not considered hazardous.

#### Cost Effectiveness Evaluation

The mean annual runoff volume (351 acre-feet) was estimated based on mean annual rainfall (13 inches) in the vicinity of the basin, an assumed runoff coefficient (0.7), and the area of the catchment (463 acres). Mean concentrations and removal efficiencies are averages of observed data. For the metals, annual load reductions ranged from 0.6 lbs for cadmium to 65 lbs for zinc. For copper, the annual load reduction is estimated at 9 lbs, which represents approximately 40 percent of the total copper that enters the basin. Table 53 summarizes the estimated cost-effectiveness for the removal of heavy metals from the pond.

**Table 53. Estimated Mean Annual Load reduction and Cost-Effectiveness\***

	Mean Concentration at Inlet (mg/L)	Average Annual Removal Efficiency	Load Reduction (lbs/yr)	Cost Effectiveness (lbs/\$1,000)
Cadmium	0.002	0.35	0.6	0.07
Chromium	0.012	0.29	3.3	0.40
Copper	0.023	0.42	9.1	1.1
Lead	0.037	0.53	18	2.2
Nickel	0.038	0.51	18	2.2
Zinc	0.156	0.44	65	7.9
TSS	87	0.50	41,000	5,000

\*Assuming an annual runoff volume of 350 acre-ft

**Solids Accumulation and Removal.** About 41,000 lbs. of suspended solids would be collected annually in the retrofitted detention basin, which represents about one-half of the annual input of solids. Assuming a specific gravity of about 1.5, this would correspond to about 16 cubic yards of material annually. If uniformly distributed over the 4.4 acre basin, the mean annual accumulation rate would be 0.03 inches per year. Sediments are expected to accumulate near the inlet and, in this specific case, in the pilot channel. In ten years, this accumulation rate would equal about 0.1 acre-feet compared with the capacity of the basin which is 30 acre-feet. Therefore, this accumulation of sediments does not pose a risk to reducing the flood control capacity of the basin. Accumulation of at least 6

inches of sediment is required before removal is practical. This amount of sediment may take as long as 10 or 20 years to accumulate.

**Capital, Operation and Maintenance Costs.** Capital and O&M costs were estimated for the retrofitted pump station and are shown in Table 54. Costs were classified as capital expenditures, operation and maintenance, and disposal. Capital costs for the structural retrofitting were based on actual costs; whereas the costs for repair of the pump electronic control systems were estimated. Operations and maintenance assumes 100 hours per year labor in addition to that already being conducted to operate and maintain the facility for flood control. Disposal costs assume disposal is conducted every 10 years and include estimated future costs for landfill fees, trucking, and excavation. The total annualized cost is therefore estimated to be \$8,200 for the 463 acre watershed, or about \$18 per acre of watershed per year. The removal costs for copper were estimated to be about 1.1 lbs removed per \$1,000, which compares very favorably with other stormwater control alternatives. As an example, it was estimated that street cleaning would remove about 1.5 lbs of copper from the streets per \$1,000 of expenditures. However, the actual cost of removing copper from runoff by street cleaning would be about ten times this amount (Pitt 1979, 1985, and 1987) (or about 0.15 lbs per \$1,000).

**Table 54. Estimated Annualized Costs for Capital Expenditures and Operation**

1. Capital Expenditures Structural retrofitting = \$15,000 Amortized over 20 years at 8%	\$1,500
2. Operations and Maintenance Inspection and repair (100 hours @ \$50/hr)	\$5,000
3. Disposal (every 10 years) Landfill (160 yd <sup>3</sup> @ \$50/yd <sup>3</sup> = \$8,000) Trucking (16 trips @ \$75/hr x 2 hrs/trip = \$2,400) Excavation (160 yd <sup>3</sup> @ \$10/yd <sup>3</sup> = \$1,600)  Disposal Subtotal = \$12,000 Amortized over 10 years at 8%	\$1,700
4. Total Cost per Year	\$8,200

## Conclusions

**Implications for Other Facilities.** According to an inventory conducted by Woodward-Clyde in 1990, nine of the existing 17 municipal pump stations in Santa Clara Valley are designed with detention basins (rather than sumps) and are, therefore, suitable for comparison with the pilot project. The detention basins range from 1.5 to 14 acres, with capacities of 4.5 to 148 acre-feet. The watershed area for each pump station ranges from 25 to 1,000 acres, and the total watershed area served by all nine stations is 4,260 acres, or 6.6 square miles. This is about 2 percent of the 350 square mile area of the Santa Clara Valley below the upland reservoirs. If we assume that other similar facilities could be retrofitted to achieve a performance comparable to that measured at Pump Station No. 2, the net reduction in copper load to the Bay would be about 100 lbs. This is only about 1 percent of the estimated mean annual load of 14,000 lbs of copper entering San Francisco Bay.

- A 100-year flood analysis indicated that modification of the pump schedule to achieve water quality benefits did not increase the maximum 100-year elevation in the pond.
- Based on measured inlet and outlet flow composite concentrations from 6 storm events, the average pollutant removal efficiencies were: total chromium, 29 percent; total copper, 42 percent; total lead, 53 percent; total nickel, 51 percent; total zinc, 44 percent; and total suspended solids, 50 percent.

- The removal efficiencies for chromium, copper, lead, nickel and zinc correlated well with TSS removal, indicating that suspended solids may be used as a surrogate parameter to monitor effectiveness of metals removal in detention basins.
- Metal concentrations of basin sediments were generally highest at the inlet location.
- None of the sediment concentrations exceeded the Total Threshold Limit Concentration (TTLC) standard, indicating that the sediments are not hazardous.
- The estimated mean annual load reduction of metals ranged between 0.6-65 lbs., depending on the metal. The mean annual load reduction for copper was 9 lbs.
- The amortized annual capital and O&M cost for retrofitting the Sunnyvale Pump Station No. 2 is estimated at \$8,200. The cost effectiveness removal rate for copper is 1.1 lb/\$1,000.
- Solids accumulation rates are very low and are estimated to be approximately 0.1 acre-feet over 10 years. Given that the basin has a capacity of 30 acre-feet, increased deposition caused by retrofitting does not increase flood risk.

***Implications for Management.***

- The total watershed area in Santa Clara Valley served by the nine pump stations with retention basins is approximately 6.6 square miles (only 2 percent of the total area of the Valley downstream of the reservoirs). Thus, even if an improved treatment performance could be obtained from these basins, the total load reduction to the Bay would be minimal. For example, the load reduction of copper would only be 100 lbs., which is less than 1 percent of the estimated mean copper load to the Bay.
- Since pump stations are relatively easy to retrofit, water quality benefits could be achieved by simply changing the pumping schedule.
- If a retrofitting program is to be pursued, it would be important to ensure that the pump control equipment is operational and well maintained, and that staff are well trained in its use.

***Retrofit Case Examples from the Center for Watershed Protection (Claytor 1998)***

The following two short case studies were provided by Rich Claytor of the Center for Watershed Protection, Ellicott City, Maryland (1998).

**Example of Retrofitting an Existing Stormwater Detention Facility, Wheaton Branch, Montgomery County, Maryland**

The Wheaton Branch facility, located near Wheaton, Maryland, is a well-know example of a former dry detention facility retrofitted to provide water quality and channel protection controls. The facility, constructed in 1990, drains an 800 acre watershed that is over 50% impervious. A unique design feature was the three cell wet pond (constructed around an existing sanitary sewer trunk main) to provide water quality controls. Extended detention controls for the 1½ inch design rainfall were incorporated for channel protection. The three cell pond has a complex flow path for both baseflows and small stormflows to facilitate maximum settling of solids. Controls for larger storms (i.e, 2 to 100 year events) were balanced against upstream backwater constraints and dam safety considerations. Figure 70 illustrates the key operational and design elements of the project.

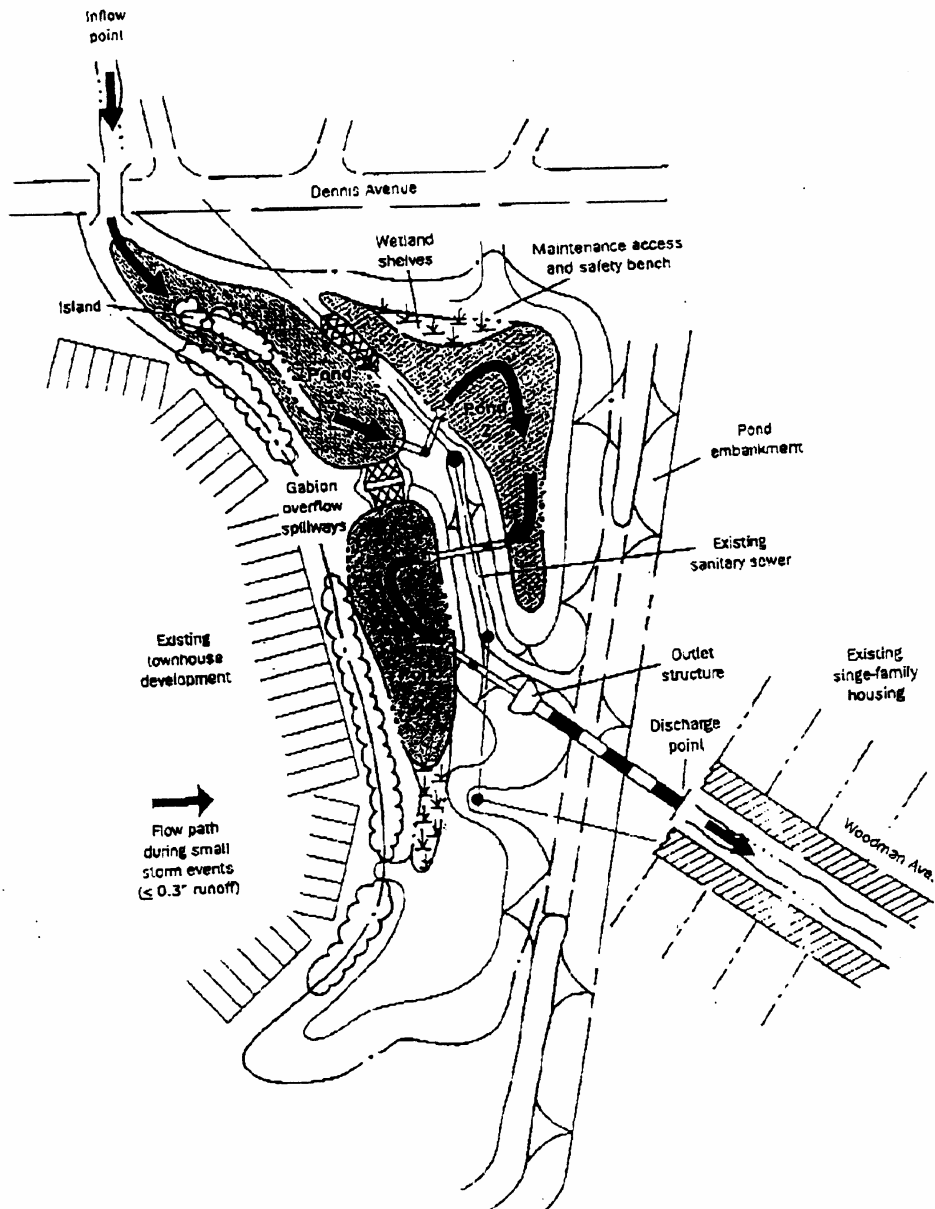

**Figure 70. Wheaton Branch, Maryland, detention facility retrofit project (Claytor 1998).**

The first cell of the facility, or forebay, provided almost a tenth of an inch per impervious acre (this is a good target minimum volume for most retrofits). A 25 ft wide access ramp with a level 30 ft by 30 ft pad was provided for future dredging. During the design phase, it was estimated that dredging of the forebay would be necessary every 5 years or so. The first cleanout of the forebay occurred in July 1997, a little over 7 years after completion of the project.

The Wheaton Branch retrofit facility was also part of the larger Sligo Creek watershed restoration project. Downstream habitat improvement and native fish restocking projects accompanied the retrofit and have proved very successful over their seven year trial period. John Galli (MWCOC), and his colleague Jim Commins (ICPRB) have published several reports and articles on the success of the stream restoration efforts in Wheaton Branch.

Some important design lessons are also illustrated by the Wheaton project. The existing hydraulic characteristics of the facility were first analyzed to assess the types of control originally provided. The original facility provided partial control of the 2, 10, and 100 year storm and safely passed the probable maximum flood (PMF) through a massive emergency spillway. The retrofit required a balancing act to maximize water quality control, while maintaining enough control for larger storms to avoid impacting downstream houses or the 100 year floodplain. Routing storms through the 3-cell pond was extremely difficult due to the very low head conditions and the unusual backwater created by downstream ponds. The original pond bottom was excavated for much of the permanent pool storage (for pond and wetland components), the emergency spillway was modified to maintain passage of the PMF and the outlet control structure was completely overhauled.

All of these measures added up to quite an expensive project. The total cost for the facility, including engineering, construction, and construction inspection was approximately \$800,000. Although this was certainly a large total sum, it was approximately \$640,000 per square mile of drainage area, somewhat less than the typically quoted figure of approximately one million dollars per acre of drainage for average effective retrofitting projects in urban areas (Karouna 1989).

### Example of a Retrofit in a Highway Right-of-Way, Bear Gutter Creek, Westchester County, New York

The Bear Gutter Creek Retrofit is one of many BMPs recently designed to protect the Kensico Reservoir (one of the principle components of New York City's drinking water system) from impacts of stormwater runoff. The Bear Gutter watershed is approximately a square mile in area and drains an area having mixed land uses of approximately 30% impervious area directly into the Kensico Reservoir. Note that this is an unfiltered drinking water system that serves millions of New Yorkers. The retrofit is located immediately below a state road culvert and within the NY Route 22 Right-of-Way.

Interesting design features include a flow diversion weir at the downstream end of an existing large diameter road culvert which diverts baseflow and stormflow for up to the 1½ inch rainfall into a primary settling area. Storms larger than the 1½ inch rainfall are diverted to a stabilized downstream channel below the facility. The primary settling chamber is sized for about a third of an inch per impervious acre and has both a wet component and storm storage above the wet pool. An existing 1½ acre emergent wetland, adjacent to the facility, receives runoff as a polishing treatment below the primary settling chamber. Figure 71 is an illustration of the facility and representative design features.

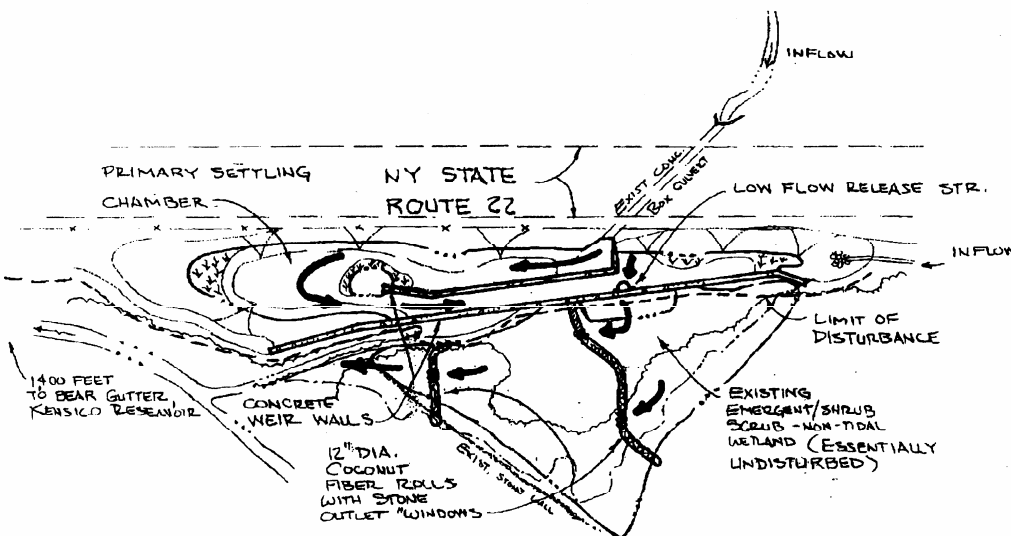

Figure 71. Bear Gutter Creek highway right-of-way urban stormwater retrofit (Claytor 1998).

The design criteria for the Bear Gutter Creek project (as well as all of the Kensico stormwater control practices) was to provide a facility with a minimum storage volume necessary to maximize particulate settling, and provide long detention times to allow for fecal coliform dieoff. An original design concept called for siting the facility within the middle of the 1½ acre wetland. Unfortunately, very little space was available within the road right-of-way or anywhere else outside of the existing wetland. The solution was to use a flow diversion structure coupled with a concrete weir and baffle to maximize a flow path within the primary settling chamber and then utilize the wetland as a “polishing” treatment. Coconut rolls were specified within the wetland to encourage additional detention for control of larger storms.

## Conclusions

This chapter has shown that the use of relatively simple design criteria can be used to provide excellent water quality benefits over a wide range of storm conditions. DETPOND can be used to evaluate a wide variety of pond designs and can be used to develop appropriate design guidelines for different climatic conditions. Wet detention ponds for water quality control can also be used to provide drainage and flood control benefits by providing additional free board storage. However, a detailed hydrologic investigation of the complete watershed is necessary to make sure that these detention ponds do not actually increase drainage and flooding problems downstream.

Detention ponds are probably the most commonly used stormwater quality devices and have substantial literature documenting their performance and problems. Wet detention ponds have been shown to be very effective, if their surface area is large enough in comparison to the drainage area and expected runoff volume. Small wet ponds and all dry ponds have been shown to be much less effective. Detention ponds can be easily integrated into a comprehensive stormwater management program, but only if land is available and if installed at the time of development. They are very difficult and expensive to retro-fit into existing areas. Care must also be taken to minimize safety and environmental hazards associated with ponds in urban areas. In addition to safety concerns, contaminated sediment management and poor water quality are major issues.

Monitoring of stormwater detention ponds is needed to confirm the adequacy of any stormwater control design criteria, including the simple criteria as presented in this paper. If the performance is different than desired, then the criteria should be appropriately adjusted. Because of the relatively large volume of water contained in detention ponds, long-term continuous monitoring of influent and effluent quality is needed. Haphazard storm event monitoring can result in inaccurate evaluations of detention ponds. The effluent of the pond for relatively small storms may not be related to the current storm's influent, but can actually be mostly made of displaced water that had resided in the pond since previous events. Also, in order to effectively design wet detention ponds, along with many other sediment practices (including grass filters, catch basins, and other types of sumps) particle size and/or settling rate analyses are necessary. This information can be obtained using conventional settling column tests directly resulting in settling velocity information. Small sieves, ranging from 20 µm to up to several hundred µm, can also be used along with total solids gravimetric analyses to obtain particle size data. These tests would result in particle diameter measurements and specific densities would have to be assumed or measured using other procedures in order to calculate settling velocities. The use of laser or other types of particle counters may also be worthwhile in order to rapidly obtain the needed particle size data.

Wet detention ponds have been shown to be an extremely robust stormwater control practice. Even though their cost may be high, their level of pollutant reduction is also high, resulting in very cost-effective pollutant removals. Physical sedimentation is the main removal process occurring in wet ponds, resulting in much better removals of particulate bound pollutants than “filterable” forms of pollutants. Fortunately, for many of the stormwater pollutants of concern, particulate forms are much more abundant than filterable forms. Wet detention ponds can also be optimized to encourage biochemical processes that can further reduce many filterable pollutants. Even though wet detention ponds have been demonstrated to provide high levels of control, they may not be the best control for all conditions. Combinations of controls, determined using a comprehensive watershed evaluation tool, are likely to result in the best control program.



## References

- Adams, L.W., D.L. Leedy, and T.M. Franklin. "Wildlife enhancement in urban stormwater control." *Proceedings of the Conference on Stormwater Detention Facilities, Planning, Design, Operation, and Maintenance*, Henniker, New Hampshire, Edited by W. DeGroot, published by the American Society of Civil Engineers, New York, August 1982.
- Adler, J. "Automatic device for emptying a detention pond at a constant low flow rate and velocity." *1981 International Symposium on Urban Hydrology, Hydraulics, and Sediment Control*, University of Kentucky, Lexington, July 1981.
- Aires, N, and J.P. Tabuchi "Hydrocarbons separators and stormwater treatment." (in French) *TSM, Special Issue «Stormwater»*, No. 11, pp. #862-864. 1995
- Akeley, R.P. "Retention ponds for control of urban stormwater quality." In *Proceedings National Conference on Urban Erosion and Sediment Control: Institutions and Technology*, EPA-905/9-80-002, Chicago, January 1980.
- Allard, L.A., E. Graham, W. Platz, R. Carr, and J. Wheeler. "The StormTreat™ system used as a storm water best management practice." *Proceedings of: Watershed '96, A National Conference on Watershed Management*. June 8 -12, 1996. Baltimore, MA. Tetra Tech, Inc. ISBN: 1-57278-028-2. pp. 463 - 465. 1996.
- Allen, H.E. (editor). *Metal Contaminated Aquatic Sediments*. Ann Arbor Press. Chelsea, MI. 350 pgs. 1996.
- Allen, S., G. McKay, and K. Khader. "Multi-component Sorption Isotherms of Basic Dyes onto Peat." *Environmental Pollution*. Vol. 52, pp. 39-55, 1988.
- Alley, W.M. "Determination of the Decay Coefficient in the Exponential Washoff Equation." *International Symposium on Urban Runoff*, University of Kentucky, Lexington, Kentucky, July 1980.
- Alley, W.M. "Estimation of Impervious-Area Washoff Parameters." *Water Resources Research*, Vol. 17, No. 4, pp 1161-1166, 1981.
- Ammon. D.C. *Urban Pollutant Buildup and Washoff Relationships*. Masters of Engineering Thesis, University of Florida, 1979.
- API (American Petroleum Institute). *Monographs of Refinery Environmental Control Management of Water Discharges. Design and Operation of Oil-water Separators*. American Petroleum Institute. Washington, D.C. 1990.
- APWA (American Public Works Assoc.). *Water Pollution Aspects of Urban Runoff*. Water Pollution Control Research Series WP-20-15, Federal Water Pollution Control Administration, January 1969.
- Aronson, G., D. Watson, and W. Pisano. *Evaluation of Catchbasin Performance for Urban Stormwater Pollution Control*. Municipal Environmental Research Laboratory: Office of Research and Development, EPA-600/2-83-043, Cincinnati, Ohio, 1983.
- Austin, Texas (City of). *Design Guidelines for Water Quality Control Basins*. Environmental DCM. City of Austin Transportation and Public Services Department. 1988.
- Ayyoubi, A. *Physical Treatment of Urban Storm Water Runoff Toxicants*. Master's Thesis. The University of Alabama at Birmingham Department of Civil Engineering, Birmingham, Alabama, 1993.
- Bannerman, R., D.W. Owens, R.B. Dodds, and N.J. Hornewer. "Sources of pollutants in Wisconsin stormwater." *Water Science and Technology*. Vol. 28, No. 3-5, pp. 241-259. 1993.
- Bannerman, R., J.G. Konrad, D. Becker, G.V. Simsiman, G. Chesters, J. Goodrich-Mahoney, and S. Abrams. *The IJC Menomonee River Watershed Study*. U.S. Environmental Protection Agency, EPA-905/4-79-029-C, Chicago, Ill., 1979.
- Bannerman, R., K. Baun, M. Bohn, P.E. Hughes, and D.A. Graczyk. *Evaluation of Urban Nonpoint Source Pollution Management in Milwaukee County, Wisconsin*. U.S. Environmental Protection Agency, PB 84-114164, Chicago, Ill., 1983.
- Bannerman, R., K. Baun, M. Bohn. P.E. Hughes, and D.A. Graczyk. *Evaluation of Urban Nonpoint Source Pollution Management in Milwaukee County, Wisconsin*. U.S. Environmental Protection Agency, PB 84-114164, Chicago, Ill., 1983.
- Barfield, B. "Analysis of the effects of existing and alternate design criteria on the performance of sediment detention ponds." *1986 Sediment and Stormwater Conference*, sponsored by the Maryland Water Resources Administration, Sediment and Stormwater Division, Salisbury State College, Maryland, July-August 1986.
- Barkdoll, M. P., D. E. Overton, and R. P. Beton. "Some Effects of Dustfall on Urban Stormwater Quality." *Water Pollution Control Federation*, 49(9):1976-84. 1977.
- Barron, P. *Characterization of Polynuclear Aromatic Hydrocarbons in Urban Runoff*. Master's Thesis. The University of Alabama at Birmingham Department of Civil Engineering, Birmingham, Alabama, 1990.

- Becker, F.A., P.D. Hedges, and R.P.M. Smisson. "The relationship between pollutants and specific sewage settling velocity fractions." *NOVATECH 95, 2<sup>nd</sup> International Conference on Innovative Technologies in Urban Storm Drainage*. May 30 - June 1, 1995. Lyon, France. pp. 607-610. Organized by Eurydice 92 and Graie. 1995.
- Bedner, R.E. and D.J. Fluke. *Demonstration of Debris Basin Effectiveness in Sediment Control*. Environmental Protection Agency, Industrial Environmental Research Laboratory - Cincinnati, EPA-600/7-80-154. Cincinnati, Ohio, 1980.
- Benke, A. C., G. E. Willeke, F. K. Parrish, and D. L. Stites. *Effects of Urbanization on Stream Ecosystems*. School of Biology, Environmental Resources Center, Report No. ERC 07-81, Georgia Institute of Technology, Atlanta, Georgia. 1981.
- Bernard, C., P. Herviou, T. Poujol, and C. Zobrist. "Procedures for treatment of stormwater and quality objectives: two practical representative examples." *Proceedings: Urban Wet Weather Pollution: Controlling Sewer Overflows and Stormwater Runoff*. Quebec City, Quebec. June 16 - 19, 1996. Water Environment Federation, Alexandria, VA. Pp. 15-59 - 15-68. 1996.
- Betson, R. P. "Precipitation and Streamflow Quality Relationships in an Urban Area." *Water Resources Research*, 14(6):1165-1169. 1978.
- Bondurant, J.A., C.E. Brockway, and M.J. Brown. "Some aspects of sedimentation pond design." *Proceedings National Symposium on Urban Hydrology and Sediment Control*, University of Kentucky, Lexington, 1975.
- Booth, D.B., C.R. Jackson. "Urbanization of aquatic systems: Degradation thresholds, stormwater detection, and the limits of mitigation." *Journal of the American Water Resources Association*. Vol. 33, no. 5, pp. 1077 – 1090. October 1997.
- Box, G.E.P., W.G. Hunter and J.S. Hunter. *Statistics for Experimenters*. John Wiley and Sons. New York, 1978.
- Branion, R. "Principles for the separation of oil drops from water in gravity type separators." In: *Oil in Freshwater: Chemistry, Biology, Countermeasure Technology*. (edited by Vandermeulen, J.H. and S.E. Hruey). Pergamon Press. New York. pp. 431-442. 1978.
- Brunsmann, J.J., J. Cornelissen, and H. Eilers. "Improved oil separation in gravity separators." *Journal of the Water Pollution Control Federation*. Vol. 34. no. 1, pp. 45-55. 1962.
- Brydges, T. and G. Robinson. "Two examples of urban stormwater impoundment for aesthetics and for protection of receiving waters." *Restoration of Lakes and Inland Waters: International Symposium on Inland Waters and Lake Restoration*. Portland, Maine, September 1980. Proceedings published by the U.S. Environmental Protection Agency, Washington, D.C. 1986.
- Burton, G.A. and R. Pitt. *Manual for Evaluating Stormwater Runoff Effects, A Tool Box of Procedures and Methods to Assist Watershed Managers*. CRC/Lewis Publishers, New York. Expected publication in 2000.
- Callahan, M.A., M.W. Slimak, N.W. Gabel, I.P. May, C.F. Fowler, J.R. Freed, P. Jennings, R.L. Durfee, F.C. Whitmore, B. Maestri, W.R. Mabey, B.R. Holt, and C. Gould. *Water Related Environmental Fates of 129 Priority Pollutants*. U.S. Environmental Protection Agency, Monitoring and Data Support Division, EPA-4-79-029a and b. Washington D.C. 1979.
- Carr, D.J., A. Geinopolos, and A.E. Zanoni. *Characteristics and Treatability of Urban Runoff Residuals*. U.S. Environmental Protection Agency, Municipal Environmental Research Laboratory, EPA-600/S2-82-094, Cincinnati, Ohio, January 1983.
- Chambers, G.M. and C.H. Tottle. *Evaluation of Stormwater Impoundments in Winnipeg*, Report SCAT-1, Environment Canada, Ottawa, April 1980.
- Cheng, S. "Detention storage optimization in least-cost sewer system design." *Second International Conference on Urban Storm Drainage*, Urbana, Illinois, June 1981.
- Chick, H. "Investigation of the laws of disinfection." *Journal of Hygiene*, No. 8, pg. 92. 1908.
- Chiou, C., and E. Kille. "Effects of Polar and Nonpolar Groups on the Solubility of Organic Compounds in Soil Organic Matter." *Environmental Science and Technology*. Vol. 28, no. 6, pp. 1139-44. 1994.
- Clark, S. and R. Pitt. *Stormwater Treatment at Critical Areas, Vol. 3: Evaluation of Filtration Media*. U.S. Environmental Protection Agency, Cooperative Agreement No. CX 824933, Water Supply and Water Resources Division, U.S. Environmental Protection Agency, Cincinnati, Ohio. To be published in 1997.
- Clark, S. *Evaluation of Filtration Media for Stormwater Runoff Treatment*. MSCE thesis prepared for the Department of Civil and Environmental Engineering, the University of Alabama at Birmingham, Birmingham, AL. 442 pgs. 1996.

- Clark, S., R. Pitt, and R. Field (1995) "Stormwater Treatment: Inlet Devices and Filtration." Presented at the *Stormwater NPDES Related Monitoring Needs* ASCE conference, Mt. Crested Butte, CO. Proceedings edited by H. Torno. Published by ASCE, New York. pp. #641-650.
- Claytor, R. *Watershed Protection Techniques*, Vol. 1, No. 4. 1995. Center for Watershed Protection. Ellicott City, Maryland
- Claytor, R.A. and W. Brown. *Environmental Indicators to Assess the Effectiveness of Municipal and Industrial Stormwater Control Programs*. Prepared for the U.S. EPA, Office of Wastewater Management. Center for Watershed Protection, Silver Spring, MD. 210 pgs. 1996.
- Claytor, R.A. "An introduction to stormwater indicators: an urban runoff assessment tool." *Watershed Protection Techniques*. Vol. 2, no. 2, pp. 321 - 328. Spring 1996a.
- Claytor, R.A. "Multiple indicators used to evaluate degrading conditions in Milwaukee County." *Watershed Protection Techniques*. Vol. 2, no. 2, pp. 348 - 351. Spring 1996b.
- Claytor, R.A. "Habitat and biological monitoring reveals headwater stream impairment in Delaware's Piedmont." *Watershed Protection Techniques*. Vol. 2, no. 2, pp. 358 - 360. Spring 1996c.
- Claytor, R.A. "An eight step approach to stormwater retrofitting--How to get them implemented." Presented at the EPA Region V *Urban Stormwater Retrofit Conference*. U.S. Environmental Protection Agency. Chicago. IL. 1998.
- Clymo, R. "Ion Exchange in Sphagnum and Its Relation to Bog Ecology." *Annals of Botany*. New series, Vol. 27, pp. 309-24. 1963.
- COE (U.S. Corps of Engineers), Hydraulic Engineering Center. *Urban Storm Water Runoff: STORM. Generalized Computer Program*. 723-58-L2520, Davis, Calif., May 1975.
- Cohen, A., M. Rollins, W. Zunic, and J. Durig. "Effects of Chemical and Physical Differences in Peats on Their Ability to Extract Hydrocarbons from Water." *Water Research*. Vol. 25, no. 9, pp. 1047-60. 1991.
- Colston, N.V., Jr. *Characterization and Treatment of Urban Land Runoff*. EPA-670/2-74-096, U.S. Environmental Protection Agency, 1974.
- Commins, J. and Stribling, J. 1992 Wheaton Branch Retrofit Project: 1990-91 Biomonitoring Project. *ICPRB Report No. 92-1*. Interstate Commission on the Potomac River Basin, Rockville, MD
- Cook, W. L., F. Parrish, J. D. Satterfield, W. G. Nolan, and P. E. Gaffney. *Biological and Chemical Assessment of Nonpoint Source Pollution in Georgia: Ridge-Valley and Sea Island Streams*, Department of Biology, Georgia State University, Atlanta, Georgia. 1983.
- Cooperative Agreement No. CR 819573. Cincinnati, 1998.
- Cowgill, U.M. "Sampling waters, the impact of sample variability on planning and confidence levels." In: *Principles of Environmental Sampling*. Edited by L.H. Keith. ACS Professional Reference Book. American Chemical Society. pp. 171-189. 1988.
- Cowherd, C. J., C. M. Maxwell, and D. W. Nelson. *Quantification of Dust Entrainment from Paved Roadways*. EPA-450 3-77-027, U.S. Environmental Protection Agency, Research Triangle Park, North Carolina. July 1977.
- Crunkilton, R., J. Kleist, J. Ramcheck, B. DeVita, and D. Villeneuve. "Assessment of the response of aquatic organisms to long-term *in situ* exposures to urban runoff." In: *Effects of Watershed Development & Management on Aquatic Ecosystems*, Engineering Foundation Conference, Snowbird, UT. ASCE, NY. August 1996.
- CTA, Inc. *Georgia Nonpoint Source Impact Assessment Study: Blue Ridge/Upland Georgia Cluster, Piedmont Cluster, and Gulf Coastal Plain Cluster*, Georgia Envir, Protection Division, Dept. of Natural Resources, Atlanta, Georgia. 1983.
- Dally, L.K., D.P. Lettenmaier, S.J. Burges, and M.M. Benjamin. *Operation of Facilities for Urban Stream Quality Enhancement*. University of Washington, Department of Civil Engineering, Water Resources Series Technical Report No. 79, Seattle, Washington, July 1983.
- Dalrymde, R.J., S.L. Hood, and D.C. Morin. *Physical and Settling Characteristics of Particulates in Storm and Sanitary Wastewaters*. EPA-670/2-79-050f, U.S. Environmental Protection Agency, Cincinnati, 1979.
- Darby, J., D. Lawler, and T. Wilshusen. "Depth Filtration of Wastewater: Particle Size and Ripening." *Research Journal. Water Pollution Control Federation*. Vol. 63, no. 3, May/June, pp. 228-38. 1991.
- Davies, P.H. "Factors in controlling nonpoint source impacts." In: *Stormwater Runoff and Receiving Systems: Impact, Monitoring, and Assessment*. Herricks, E. E., editor, CRC/Lewis Publishers, Boca Raton, Fla. pp. 53-64. 1995.
- Davis, E.M. *Maximum Utilization of Water Resources in a Planned Community - Bacterial Characteristics of Stormwater in Developing Areas*. EPA-600/2-79-050, U.S. Environmental Protection Agency, 1979.

- Davis, R., X. Zhang, and J. Agarwala. "Particle Classification for Dilute Suspensions Using an Inclined Settler." *Industrial and Engineering Chemistry Research*. Vol. 28, pp. 785-93. 1989.
- Davis, W.J., R.H. McCuen, and G.E. Kamedulski. "The effect of storm water detention on water quality." *International Symposium on Urban Storm Water Management*, University of Kentucky, Lexington, Kentucky, July 1978.
- Debo, D N. and H. Ruby. "Detention basins -- An urban experience." *Public Works*. Vol. 113, No. 1, pg. 42, January, 1982.
- Debo, T.N. "Detention ordinances -- Solving or causing problems?" *Proceedings of the Conference on Stormwater Detention Facilities, Planning, Design, Operation, and Maintenance*, Henniker, New Hampshire, Edited by W. DeGroot, published by the American Society of Civil Engineers, New York, August 1982.
- Delaine, J. "Separating oil from water offshore." *The Chemical Engineer*. No. 419 pp. 31-34. 1995.
- Delporte, C. "Treating rainfall - enhancing discharges from urban areas using lamellar decantation." *Proceedings: Urban Wet Weather Pollution: Controlling Sewer Overflows and Stormwater Runoff*. Quebec City, Quebec. June 16 - 19, 1996. Water Environment Federation, Alexandria, VA. Pp. 15-1 - 15-9. 1996.
- Denver Regional Council of Governments. *Urban Runoff Quality in the Denver (Colorado) Region*. Prepared for the U.S. EPA. Washington, D.C. PB85-101640. Sept. 1983.
- DePinto, J.V., T.C. Young and S.C. Martin. "Aquatic Sediments." *Journal of Water Pollution Control Federation*. Vol. 52. No. 6. pp 1656-70. 1980.
- Dewberry and Davis, Inc. *Investigation of Potential Sediment Toxicity from BMP Ponds*. Prepared for the Northern Virginia Planning District Commission, the Occoquan Policy Board, and the Virginia State Water Control Board. May 1990.
- Donigian, A.S., Jr. and N.H. Crawford. *Modeling Nonpoint Pollution from the Land Surface*. EPA-600/3-76-083, U.S. Environmental Protection Agency, Athens, Georgia, July 1976.
- Driscoll, E. D. "Detention and retention controls for urban stormwater." *Engineering Foundation Conference: Urban Runoff Quality - Impact and Quality Enhancement Technology*, Henniker, New Hampshire, edited by B. Urbonas and L. A. Roesner, published by the American Society of Civil Engineers, New York, June 1986.
- Driscoll, E. D. "Long term performance of water quality ponds." *Engineering Foundation Conference: Design of Urban Runoff Quality Controls*. Potosi, Missouri. July 10 - 15, 1988. Edited by L. A. Roesner, B. Urbonas and M.B. Sommen. Published by the American Society of Civil Engineers, New York, June 1989.
- Driscoll, E.D. and E.W. Strecker "Assessment of BMP's being used in the U.S. and Canada." *Proceedings of the 6<sup>th</sup> International Conference on Urban Storm Drainage*. Edited by J. Marsalek and H.C. Torno. Niagara Falls, Ontario. September 12 - 17, 1993. IAWQ, London. Published by Seapoint Publishers, Victoria, B.C. pp. 945 - 950. 1993.
- Droste, R.L. and J.C. Johnston. "Urban snow dump quality and pollutant reduction in snowmelt by sedimentation." *Canadian Journal of Civil Engineering*. Vol. 20, pp. 9-21. February 1993.
- Dull, L. *Survey of Oil/Water Separating System Technologies - Methods and Their Applications in Controlling Pollutants of Concern in Wastewater from Transit Bases*. Seattle Metro, Seattle, WA. 1984.
- Duru, J. O. "On-site detention: A stormwater management or mismanagement technique." *Second International Conference on Urban Storm Drainage*, Urbana, Illinois, June 1981.
- Durum, W. H. "Occurrence of Some Trace Metals in Surface Waters and Groundwaters." In *Proceeding of the Sixteenth Water Quality Conference*, Am. Water Works Assoc., et al. Univ. of Illinois Bull., 71(108), Urbana, Illinois. 1974.
- Dyer, S.D. and C.E. White. "A watershed approach to assess mixture toxicity via integration of public and private databases." *Abstract Book: SETAC 17<sup>th</sup> Annual Meeting*. pg. 96. Washington, D.C., Nov. 17 - 21, 1996.
- Ebbert, J. C., J. E. Poole, and K. L. Payne. *Data Collected by the U.S. Geological Survey During a Study of Urban Runoff in Bellevue, Washington, 1979-82*. Preliminary U.S. Geological Survey Open-File Report, Tacoma, Washington. 1983.
- Eccher, C.J. "Thoughtful design is prime factor in water safety." *Lake Line*. pp. 4-8. May 1991.
- Ehrenfeld, J. G. and J. P. Schneider *The Sensitivity of Cedar Swamps to the Effects of Non-Point Pollution Associated with Suburbanization in the New Jersey Pine Barrens*, PB8-4-136779, U.S. Environmental Protection Agency, Office of Water Policy, Washington, D.C.. 1983.
- Ellis, J.B. "Wetland BMP design for urban runoff pollution control in Europe and Australia." *Proceedings of the 6<sup>th</sup> International Conference on Urban Storm Drainage*. Edited by J. Marsalek and H.C. Torno. Niagara Falls,

- Ontario. September 12 - 17, 1993. IAWQ, London. Published by Seapoint Publishers, Victoria, B.C. pp. 957 - 962. 1993.
- Ellis, J.B., R. Hamilton, and A.H. Roberts. "Composition of Suspended Solids in Urban Stormwater." *Second International Conference on Urban Storm Drainage*, Urbana, Illinois, June 1981.
- Emmerling-DiNovo, C. "Stormwater detention basins and residential locational decisions." *Water Resources Bulletin*. Vol. 31, no. 3, pp. 515-521. June 1995.
- Environmental Protection Agency (U.S.). *Methodology for Analysis of Detention Basins for Control of Urban Runoff Quality*. Water Planning Division, EPA 440/5-87-001, Washington, D.C., September 1986.
- Environmental Science & Technology*. "News Briefs." Vol. 30, no. 7, pg. 290a. July 1996b.
- Environmental Science & Technology*. "Toxicity of aquatic mixtures yielding to new theoretical approach." Vol. 30, no. 4, pp. 155a - 156a. April 1996a.
- EPA (USA Environmental Protection Agency). *Final Report for the Nationwide Urban Runoff Program*. Water Planning Division, PB 84-185552, Washington, D.C., December 1983.
- EPA. *Methods for Chemical Analysis of Water and Wastes*, EPA-600/4-79-020, U.S. Environmental Protection Agency, Cincinnati, Ohio. 1983b.
- Fair, G.M. and J.C. Geyer. *Water Supply and Waste Water Disposal*. John Wiley and Sons. New York. 1954.
- Ferarra, R. A. "Stormwater detention and nonpoint source pollution control." *1982 International Symposium on Urban Hydrology, Hydraulics and Sediment Control*, University of Kentucky, Lexington, Kentucky, July 1982.
- Field, R. and A.N. Tafuri. *Urban Runoff Pollution Control Technology Overview*. U.S. Environmental Protection Agency, EPA-600/2-77-047, Cincinnati, Ohio, 1977.
- Field, R. and R. Pitt. "Combined sewer overflow control through in-receiving water storage: an efficiency evaluation." *Water Environment Federation Specialty Conference on A Global Perspective for Reducing CSOs: Balancing Technologies, Costs, and Water Quality*. Louisville, KY. July 1994a.
- Field, R. and R. Pitt. "Optimization of CSO storage and treatment systems." *Water Environment Federation Specialty Conference on A Global Perspective for Reducing CSOs: Balancing Technologies, Costs, and Water Quality*. Louisville, KY. July 1994b.
- Field, R. and R. Pitt. "Urban storm-induced discharge impacts: US Environmental Protection Agency research program review." *Water Science and Technology*. Vol. 22, No. 10/11. pp. 1-7. 1990.
- Field, R. M.P. Brown, W.V. Vilkelis. *Stormwater Pollution Abatement Technologies*. U.S. Environmental Protection Agency, Office of Research and Development. Cincinnati. OH. EPA/600/R-94/129. 1994.
- Field, R., and R. Turkeltaub. "Urban runoff receiving water impacts: program overview." *Journal of Environmental Engineering*, 107:83-100. 1981.
- Field, R., E.J. Struzeski, Jr., H.E. Masters and A.N. Tafuri. *Water Pollution and Associated Effects from Street Salting*. EPA-R2-73-257, U.S. Environmental Protection Agency, Cincinnati, Ohio. May 1973.
- Field, R., M. O'Shea, and K. Chin, (eds.). *Integrated Stormwater Management*. Lewis Publishers, Boca Raton, Florida, 1993.
- Field, R., R. Pitt, M. Brown, and T. O'Conner. "Combined sewer overflow control using storage in seawater." *Water Research*. Elsevier Science. Vol. 29, No. 6, pp. 1505-1514. 1995.
- Field, R., R. Pitt, M. Lalor, M. Brown, W. Vilkelis, and E. Thackston. "Investigation of dry-weather pollutant entries into storm-drainage systems." *J. Envir. Eng.* Vol. 120, No. 5, pp. 1044-1066. Sept./Oct. 1994.
- Ford, D. "Technologies for removal of hydrocarbons from surface and groundwater sources." In: *Oil in Freshwater: Chemistry, Biology, Countermeasure Technology*, (edited by Vandermeulen, J.G. and S.E. Hruely), Pergamon Press. New York. pp. 413-430. 1978.
- Forndran, A., R. Field, K. Dunkers, and D. Moran. "Balancing flow for CSO abatement." *Water Environment & Technology*. pp. 54-58. May 1991.
- Fourage, M. "Assessment of the efficiency of a prefabricated separator for stormwater treatment. Thoughts to and tests of materials to trap hydrocarbons." (in French) *Unpublished DESS student report, Universities of Nancy and Metz*, September 1992.
- Fram, S., M.K. Stenstrom, and G. Silverman. "Hydrocarbons in urban runoff." *Journal of Environmental Engineering*, 113:1032-1046. 1987.
- Free, B. M. and G. G. Mulamootil. "The limnology of Lake Wabukayne; A storm-water impoundment." *Water Resources Bulletin*, Vol. 19, No. 5, pg. 821, October 1983.
- Fuhr, M. "Will your pond hold water?" *Land and Water*, Vol. 40, no. 6, pg. 38. Nov./Dec. 1996.

- Galli, J. and Schueler, T. 1992 Wheaton Branch Stream Restoration Project. In: *Watershed Restoration Sourcebook*. Metropolitan Washington Council of Governments, Washington, DC.
- Galli, J. *Peat-Sand Filters: A Proposed Stormwater Management Practice for Urbanized Areas*. Prepared for the Coordinated Anacostia Retrofit Program and Office Of Policy and Planning, D.C. Department of Public Works. 1990
- Garie, H. L. and A. McIntosh. "Distribution of benthic macroinvertebrates in a stream exposed to urban runoff." *Water Resources Bulletin*, 22, 447. 1986.
- Garie, H. L. and A. McIntosh. "Distribution of benthic macroinvertebrates in a stream exposed to urban runoff." *Water Science and Technology*, 22, 10/11. 1990.
- Gietz, R. J. *Stormwater Runoff Treatment by Impoundment: Barrhaven Pilot Study*. Report SCAT-8, Environment Canada, Ottawa, 1981.
- Gietz, R. J. *Urban Runoff Treatment in the Kennedy-Burnett Settling Pond*. For the Rideau River Stormwater Management Study, Pollution Control Division, Works Department, Regional Municipality of Ottawa-Carleton, Ottawa, Ontario, March 1983.
- Gilbert, R. *Statistical Methods for Environmental Pollution Monitoring*. Van Nostrand Reinhold, New York, 1987.
- Green, M.B. and J.R. Martin. "Constructed reed beds clean up storm overflows on small wastewater treatment works." *Water Environment Research*. Vol. 68, no. 6, pp. 1054 - 1060. Sept./Oct. 1996.
- Greenberg, A., L. Clesceri, and A. Eaton, (eds.). *Standard Methods for the Examination of Water and Wastewater, 18th ed.* American Public Health Association, American Water Works Association, Water Environment Federation, Washington, D.C., 1992.
- Grizzard, T. J., C. W. Randall, B. L. Weand, and K. L. Ellis. "Effectiveness of extended detention ponds." *Engineering Foundation Conference: Urban Runoff Quality - Impact and Quality Enhancement Technology*, Henniker, New Hampshire, edited by B. Urbonas and L. A. Roesner, published by the American Society of Civil Engineers, New York, June 1986.
- Gupta, M., D. Mason, M. Clark, T. Meinholz, C. Hansen, and A. Geinopolos, *Screening/Flotation Treatment of Combined Sewer Overflows Volume 1 - Bench Scale and Pilot Plant Investigations*. EPA- 600/2-77-069a, U.S. Environmental Protection Agency, Cincinnati, Ohio, August 1977.
- Gupta, M.K., R.W. Agnew, and N.P. Kobriger. *Constituents of Highway Runoff*. Volume one of a six volume series, Federal Highway Administration, U.S. Department of Transportation, FHWA/RD-81/042, Washington, D.C., 1981.
- Haile, R.W., J. Alamillo, K. Barrett, R. Cressey, J. Dermond, C. Ervin, A. Glasser, N. Harawa, P. Harmon, J. Harper, C. McGee, R.C. Millikan, M. Nides, and J.S. Witte. *An Epidemiological Study of Possible Health Effects of Swimming in Santa Monica Bay*. Santa Monica Bay Restoration Project. Monterey Park, CA. May 1996.
- Hall, M.J. "The design of flood storage ponds: catering for both quality and quantity of runoff." *Developments in Storm Drainage - A Symposium on Infiltration and Storage of Stormwater in New Developments*. Sheffield City. Jan. 1990. Pp. 21 - 33. 1990.
- Harper, H.H. and J.L. Herr. "Alum treatment of stormwater - The first ten years: What have we learned and where do we go from here?" North American Lake Management Society (NALMS) Conference presentation. Minneapolis/St. Paul. October 1996.
- Harrington, B. W. *Feasibility and Design of Wet Ponds to Achieve Water Quality Control*. Sediment and Stormwater Division, Maryland Water Resources Administration, July 1986.
- Hawley, M. E., T. R. Bondelid, and R. H. McCuen. "A planning method for evaluating downstream effects of detention basins." *Water Resources Bulletin*, Vol. 17. No. 5, pg. 806, October 1981.
- Hazen and Sawyer, Inc. and Center for Watershed Protection, 1997. *Final Site Plan for BMP 67, Sub-Basin BGC-5*. Kensico Watershed Stormwater Best Management Facilities. Westchester, NY
- Heimbuch, R.J. "Rock filled detention reservoirs." *1981 International Symposium on Urban Hydrology, Hydraulics, and Sediment Control*, University of Kentucky, Lexington, July 1981.
- Heinzmann, B. "Coagulation and flocculation of stormwater from a separated storm sewer - A new possibility for enhanced treatment." *2<sup>nd</sup> International Conference on: Upgrading of Wastewater Treatment Plants*. Berlin. September 21 - 24, 1993. Sponsored by IAWQ and EWPCA. Pp. 304 - 313. 1993.
- Herr, J.L. and H.H. Harper. "The evaluation and design of an alum stormwater treatment system to improve water quality in Lake Maggiore, St. Petersburg, Florida" North American Lake Management Society (NALMS) Conference presentation. Minneapolis/St. Paul. October 1996.

- Herricks, E.E., editor. *Stormwater Runoff and Receiving Systems: Impact, Monitoring, and Assessment*. Engineering Foundation and ASCE. CRC/Lewis. Boca Raton, FL. 1995.
- Herricks, E.E., I. Milne, and I. Johnson. "A protocol for wet weather discharge toxicity assessment." Volume 4, pg. 13 - 24. *WEFTEC'96: Proceedings of the 69<sup>th</sup> Annual Conference & Exposition*. Dallas, Texas. 1996a.
- Herricks, E.E., R. Brent, I. Milne, and I. Johnson. "Assessing the response of aquatic organisms to short-term exposures to urban runoff." In: *Effects of Watershed Development & Management on Aquatic Ecosystems*, Engineering Foundation Conference, Snowbird, UT. ASCE, NY. August 1996b.
- Hey, D.L. and G.C. Schaefer. *An Evaluation of the Water Quality Effects of Detention Storage and Source Control*. U.S. Environmental Protection Agency and the Northeastern Illinois Planning Commission, Chicago, August 1983.
- Hittman Assoc. *Methods to Control Fine-Grained Sediments Resulting from Construction Activity*. U.S. Environmental Protection Agency, Pb-279 092, Washington, D.C., December 1976.
- Hoffman, E.J., G.L. Mills, J.S. Latimer, and J.G. Quinn. "Urban runoff as a source of polycyclic aromatic hydrocarbons to coastal waters." *Environment Science and Technology*, 18:580-587. 1984.
- House, L.B., R.J. Waschbusch, and P.E. Hughes. *Water Quality of an Urban Wet Detention Pond in Madison, Wisconsin, 1987-1988*. U. S. Geological Survey, in cooperation with the Wisconsin Department of Natural Resources. USGS Open File Report 93-172, 1993.
- Huber, W.C. and J.P. Heaney. "The USEPA Storm Water Management Model, SWMM: A Ten Year Perspective." *Second International Conference on Urban Storm Drainage*, Urbana, Illinois, June 1981.
- Hütter, U. and F. Remmler. "Stormwater infiltration at a site with critical subsoil conditions: Investigations of soil, seepage water, and groundwater." *7<sup>th</sup> International Conference on Urban Storm Drainage*. Hannover, Germany. Sept. 9-13, 1996. Edited by F. Sieker and H-R. Verworn. IAHR/IAWQ. SuG Verlagsgesellschaft. Hannover, Germany. pp. 713-718. 1996.
- Hvitved-Jacobsen, T., K. Keiding, and Y.A. Yousef. "Urban runoff pollution removal in wet detention ponds." *Proceedings of the 4<sup>th</sup> International Conference on Urban Storm Drainage*. Lausanne, Switzerland. August 1987. Water Resources Publications. pp. 137 - 142. 1987.
- Hvitved-Jacobsen, T., N.B. Johansen, and Y.A. Yousef. "Treatment systems for urban and highway runoff in Denmark." *The Science of the Total Environment*. No. 146/147, pp. 499-506. 1994.
- Ireland, D.S., G.A. Burton, Jr., and G.G. Hess. "In-situ toxicity evaluations of turbidity and photoinduction of polycyclic aromatic hydrocarbons." *Environmental Toxicology and Chemistry*. Vol. 15, no. 4, pp. 574 -581. April 1996.
- James, W. and Robinson, M. A. (1982). "Continuous models essential for detention design." *Proceedings of the Conference on Stormwater Detention Facilities*, American Society of Civil Engineers, 163-175.
- Jewell, T.K., D.D. Adrian and D.W. Hosmer. "Analysis of Stormwater Pollutant Washoff Estimation Techniques." *International Symposium on Urban Storm Runoff*, University of Kentucky, Lexington, Kentucky, July 1980.
- Johnson, I., E.E. Herricks, and I. Milne. "Application of a test battery for wet weather discharge toxicity analyses." Volume 4, pg. 219 - 229. *WEFTEC'96: Proceedings of the 69<sup>th</sup> Annual Conference & Exposition*. Dallas, Texas. 1996.
- Jones, J. "Beware the sediment scare." *Civil Engineering*. pp. 56-57. July 1995.
- Jones, J. E. and D. E. Jones, "Interfacing considerations in urban detention ponding." *Proceedings of the Conference on Stormwater Detention Facilities, Planning, Design, Operation, and Maintenance*, Henniker, New Hampshire, Edited by W. DeGroot, published by the American Society of Civil Engineers, New York, August 1982.
- Jones, J., S. Anderson, J. Fognani, F.R. McGregor, and T. Axley. "Stormwater best management practices: When is sediment considered hazardous?" *Water Environment & Technology*. Vol. 8, no. 10, pp. 51-57. October 1996.
- Kamedulski, G. E. and R. H. McCuen. "The effect of maintenance on storm water detention basin efficiency." *Water Resources Bulletin*, Vol. 15, No. 4, pg. 1146, August 1979.
- Karamanev, D., M. Bélanger, C. Chavarie, J. Chaouki, and R. Mayer. "Hydrodynamic Characteristics of a Trickling Bed of Peat Moss Used for Biofiltration of Wastewater," *The Canadian Journal of Chemical Engineering*. Vol. 72, pp. 411-17. 1994.
- Karouna, N. 1989, Cost Analysis of Urban Retrofits. Unpublished Report. Metropolitan Washington Council of Governments. Washington, DC.
- King County, Washington. *Small Quantity Generator Oily Wastewater Management Study*. Local Hazardous Waste Management Program in King County. Washington. 44 pp. 1995.
- Klein, R. D. "Urbanization and stream quality impairment." *Water Resources Bulletin*, 15. 1979.

- Kloiber, S.M. and P.L. Brewonik. "Effectiveness of continuous alum treatment for phosphorus removal from stormwater." North American Lake Management Society (NALMS) Conference presentation. Minneapolis/St. Paul. October 1996.
- Kobriger, N.P., T.L. Meinholz, M.K. Gupta, and R.W. Agnew. *Constituents of Highway Runoff. Vol. 3. Predictive Procedure for Determining Pollution Characteristics in Highway Runoff.* FHWA/RD-81/044. Federal Highway Administration. Washington, D.C. February 1981.
- Koeppel, D. E., comp. Vol. IV: "Soil-Water-Air-Plant Studies." In: *Environmental Contamination by Lead and Other Heavy Metals*, G. L. Rolfe and K. A. Peinbold, eds. Institute for Environmental Studies, Univ. of Illinois, Urbana-Champaign, Illinois. July 1977.
- Kronis, H. *Physical-Chemical Treatment and Disinfection of Stormwater.* Research Report No 88, Wastewater Treatment Section, Ontario Ministry of the Environment, Toronto, March 1982.
- Lager, J., W. Smith, and G. Tchobanoglous. *Catchbasin Technology Overview and Assessment.* EPA-600/2-77-051, U.S. Environmental Protection Agency, Cincinnati, Ohio, May, 1977.
- Lake Line "The Nutri-Pod: A new way." pp. 2-19. February 1991.
- Land and Water "Storm pond turned into selling feature" Vol. 40, no. 6, pg. 35. Nov./Dec. 1996.
- Laplace, D., A. Bachoc, Y. Sanchez, and D. Dartus. "Truck sewer clogging development - description and solutions." *Water Science and Technology.* Vol. 25, No. 8, pp. 91-100. 1992.
- Lawler, Matusky and Skelly Engineers and Fanning and Phillips. Chapter 5: *The Long Island Segment of the Nationwide Urban Runoff Program*, Final Draft Report to the Long Island Regional Planning Board, Long Island, New York, June 1982.
- Lee, G.F. and A. Jones-Lee. "Water quality impacts of stormwater-associated contaminants: focus on real problems." *Water Science and Technology.* Vol. 28, No. 3-5, pp. 231-240. 1993.
- Lee, G.F. and A. Jones-Lee. "Deficiencies in stormwater quality monitoring." in: *Stormwater NPDES Related Monitoring Needs*, Engineering Foundation Conference, Mt. Crested Butte, CO. ASCE, NY. pp. 651-662. 1995.
- Legrand, J., H. Maillot, F. Nougarede, and S. Defontaine (1994) "A device for stormwater treatment in the urban development zone of Annœullin." (in French) *TSM*, No. 11, pp. #639-643.
- Lenat, D. R., D. L. Penrose, and K. W. Eagleson. "Variable effects of sediment addition on stream benthos." *Hydrobiologia*, 79, 187. 1981.
- Lenat, D. and K. Eagleson. *Ecological Effects of Urban Runoff on North Carolina Streams*, North Carolina Division of Environmental Management, Biological Series #104, North Carolina Dept. of Natural Resources and Community Development, Raleigh, North Carolina. 1981.
- Lenat, D. R., D. L. Penrose, and K. Eagleson. *Biological Evaluation of Non-Point Sources of Pollutants in North Carolina Streams and Rivers*, North Carolina Division of Environmental Management, Biological Series #102, North Carolina Dept. of Natural Resources and Community Development, Raleigh, North Carolina. 1979.
- Lettenmaier, D. P. and L. K. Dally. *Stormwater Quality Evaluation for Metro Transit East Operating Base*, Department of Civil Engineering, University of Washington, Seattle, Washington, June 1983.
- Lindsay, W. L. *Chemical Equilibria in Soils.* John Wiley and Sons, New Trk. 1979.
- Linsley, R. K., and J. B. Franzini. *Water Resources Engineering.* McGraw-Hill, New York, 1964.
- Luzkow, S. M., D. A. Scherger, and J. A. Davis. "Effectiveness of two in-line urban storm water best management practices (BMP'S)." *1981 International Symposium on Urban Hydrology, Hydraulics, and Sediment Control*, University of Kentucky, Lexington, Kentucky, July 1981.
- MacRae, C.R. "Experience from morphological research on Canadian streams: Is control fo the two-year frequency runoff event the best basis for stream channel protection?" Presented at the *Effects of Watershed Developments and Management on Aquatic Ecosystems* conference. Snowbird, UT, August 4 – 9, 1996. Edited by L.A. Roesner. ASCE, New York, 1997.
- Magmedov, V.G., M.A. Zakharchenko, L.I. Yakovleva, and M.E. Ince. "Use of constructed wetlands for the treatment of runoff and drainage waters: the UK and Ukraine experience." *Water Science and Technology.* Vol. 33, no. 4 - 5, pp. 315-323. 1996.
- Malmquist, Per-Arne. *Atmospheric Fallout and Street Cleaning - Effects on Urban Stream Water and Snow.* Prog. Wat. Tech., 10(5/6): 495-505, 1978. Pergamon Press, Great Britain. September 1978.
- Mancini, J. and A. Plummer. "Urban runoff and water quality criteria." In: *Urban Runoff Quality – Impact and Quality Enhancement Technology.* Edited by B. Urbonas and L.A. Roesner. Engineering Foundation Conference, Henniker, Hew Hampshire. ASCE, NY. pp. 133-149. June 1986.



- Manning, M.J., R.H. Sullivan, and T.M. Kipp. *Nationwide Evaluation of Combined Sewer Overflows and Urban Stormwater Discharges, Vol. III: Characterization of Discharges*. U.S. Environmental Protection Agency, Cincinnati, Ohio. October 1976.
- Marcy, S. and J. Gerritsen. "Developing diverse assessment endpoints to address multiple stressors in watershed ecological risk assessment." Abstract Book: *SETAC 17<sup>th</sup> Annual Meeting*. pg. 96. Washington, D.C., Nov. 17 - 21, 1996.
- Marcy, S. J. and J. E. Flack. "Safety considerations in urban storm drainage design." *Second International Conference on Urban Storm Drainage*, Urbana, Illinois, June 1981.
- Marsalek, J., D. Weatherbe, and G. Zukovs. "Institutional aspects of stormwater detention." *Proceedings of the Conference on Stormwater Detention Facilities, Planning, Design, Operation, and Maintenance*, Henniker, New Hampshire, Edited by W. DeGroot, published by the American Society of Civil Engineers, New York, August 1982.
- Martin, E. and R.A. Miller. "Efficiency of an urban stormwater detention system." *Proceedings of the 4<sup>th</sup> International Conference on Urban Storm Drainage*. Lausanne, Switzerland. August 1987. Water Resources Publications. pp. 143 - 148. 1987.
- Martin, E.H. "Mixing and residence times of stormwater runoff in a detention system." Engineering Foundation Conference: *Design of Urban Runoff Quality Controls*. Potosi, Missouri. July 10 - 15, 1988. Edited by L. A. Roesner, B. Urbonas and M.B. Sommen. pp. 164 - 179. Published by the American Society of Civil Engineers, New York, June 1989.
- Mason, J.M., Jr. "Multistaged outlet control for small on-site detention." *1981 International Symposium on Urban Hydrology, Hydraulics, and Sediment Control*, University of Kentucky, Lexington, July 1981.
- Mason, J.M., Jr. "On-site stormwater detention: An overview." *Public Works*, February 1982.
- Maxted, J. and E. Shaver. "The use of retention basins to mitigate stormwater impacts on aquatic life." Engineering Foundation Conference: *Effects of Watershed Development & Management on Aquatic Ecosystems*. Snowbird, Utah. August 4-9, 1996. Engineering Foundation, New York, 1997.
- Mayer, T., J. Marsalek, and E. Delos Reyes. "Nutrients and metal contaminants status of urban stormwater ponds." *Journal of Lake and Reservoir Management*. Vol. 12, no. 3, pp. 348-363. 1996.
- McComas, S. R. and D. F. Sefton. "Comparison of stormwater runoff impacts on sedimentation and sediment trace metals for two urban impoundments." In: *Lake and Reservoir Management: Practical Applications*, proceedings of the Fourth Annual Conference and International Symposium, October, 1984, North American Lake Management Society, McAfee, New Jersey, 1985.
- McCuen, R. H. *A Guide to Hydrologic Analysis Using SCS Methods*. Prentice-Hall, Englewood Cliffs, New Jersey, 1982.
- McCuen, R.H. "Stormwater modeling into the 21st century." *Sediment and Stormwater Conference*, sponsored by the Maryland Sediment and Stormwater Division, Water Resources Administration, Salisbury, Maryland, July-August 1986.
- McCuen, R.H. "Water quality trap efficiency of storm water management basins." *Water Resources Bulletin*, 16(1):15-21, February 1980.
- McCuen, R.H., S.G. Walesh, and W.J. Rawis. *Control of Urban Stormwater Runoff by Detention and Retention*, Misc. Public. No. 1428, U.S. Dept. of Agric., 1984(?).
- Medeiros, C. and R. A. Coler. *A Laboratory/Field Investigation into the Biological Effects of Urban Runoff*, Water Resources Research Center, University of Massachusetts, Amherst, Massachusetts. 1982.
- Medeiros, C., R. A. Coler, and E. J. Calabrese. "A laboratory assessment of the toxicity of urban runoff on the fathead minnow (*Pimephales promelas*)," *Journal of Environmental Science Health*, A19, 847. 1984.
- Metropolitan Washington Council of Governments. *Analysis of Urban BMP Performance and Longevity*. Prince George's County, Department of Environmental Resources. 1992.
- Mikkelsen, P.S., K. Arngjerg-Nielsen, and P. Harremoës. "Consequences for established design practice from geographical variation of historical rainfall data." *Proceedings: 7<sup>th</sup> International Conference on Urban Storm Drainage*. Hannover, Germany. Sept. 9 - 13, 1996a.
- Mikkelsen, P.S., M. Häfliger, M. Ochs, J.C. Tjell, M. Jacobsen, and M. Boller. "Experimental assessment of soil and groundwater contamination from two old infiltration systems for road run-off in Switzerland." *Science of the Total Environment*. 1996b.

- Mote Marine Laboratory. *Biological and Chemical Studies on the Impact of Stormwater Runoff upon the Biological Community of the Hillsborough River, Tampa, Florida*, Stormwater Management Division, Dept. of Public Works, Tampa, Florida. 1984.
- Mull, R. "Water exchange between leaky sewers and aquifers." *7<sup>th</sup> International Conference on Urban Storm Drainage*. Hannover, Germany. Sept. 9-13. Edited by F. Sieker and H-R. Verworn. IAHR/IAWQ. SuG-Verlagsgesellschaft. Hannover, Germany. pp. 695-700. 1996.
- Murphy, W. *Roadway Particulate Losses*: American Public Works Assoc. Unpublished. 1975.
- Niemczynowicz, J. "Swedish stormwater detention practices." *Proceedings of the 5<sup>th</sup> International Conference on Urban Storm Drainage*. Osaka, Japan. July 1990. pp. 197 - 202. 1990.
- Nix, S.J. and S.R. Durrans. "Off-line stormwater detention systems." *Water Resources Bulletin*. Vol. 32, no. 6, pp. 1329 - 1340. December 1996.
- Novotny, V. and G. Chesters. *Handbook of Nonpoint Pollution Sources and Management*. Van Nostrand Reinhold Company, New York, 1981.
- Novotny, V., and Olem, H. *Water Quality: Prevention, Identification, and Management of Diffuse Pollution*. Van Nostrand Reinhold, New York, 1994.
- Oberts, G. "Design considerations for management of urban runoff in wintry conditions." *Proceedings: International Conference on Urban Hydrology under Wintry Conditions*. March 19 - 21, 1990. Narvik, Norway. 1990.
- Oberts, G. Performance of stormwater ponds and wetlands in winter." Technical note 16. *Watershed Protection Techniques*. Vol. 1, no. 2, pp. 64-68. Summer 1994.
- Oliver, L.J. and S.G. Grigoropoulos. "Control of storm-generated pollution using a small urban lake." *Journal Water Pollution Control Federation*, Vol 53, No. 5, May 1981.
- Ontario Ministry of the Environment. *Province of Ontario Urban Drainage Design Guidelines (Draft)*. Urban Drainage Policy Implementation Committee, Ontario Ministry of the Environment, Toronto, Ontario, March 1984.
- Oscanyan, P. C. "Design of sediment basins for construction sites." *National Symposium on Urban Hydrology and Sediment Control*, University of Kentucky, Lexington, Kentucky, 1975.
- Parmer, K. *Photo and Biodegradation of Pyrene and Benzo (a) pyrene in a Model of the Near Surface Environment*. Ph.D. dissertation. Department of Environmental Health Sciences, School of Public Health. The University of Alabama at Birmingham. 1993.
- PEDCo-Environmental, Inc. *Control of Re-entrained Dust from Paved Streets*. EPA-907/9-77-007, U.S. Environmental Protection Agency, Kansas City, Missouri. 1977.
- Pedersen, E. R. *The Use of Benthic Invertebrate Data for Evaluating Impacts of Urban Stormwater Runoff*, Masters thesis submitted to the College of Engineering, University of Washington, Seattle. 1981.
- Perkins, M. A. "Managing aquatic plants with fiberglass screens." In: *Restoration of Lakes and Inland Waters, proceedings of the International Symposium on Inland Waters and Lake Restoration*, Portland, Maine, September 1980, published by the U.S. Environmental Protection Agency, Washington. D.C., December 1980.
- Perkins, M. A. *An Evaluation of Instream Ecological Effects Associated with Urban Runoff to a Lowland Stream in Western Washington*. U.S. Environmental Protection Agency, Corvallis Environmental Research Laboratory, Corvallis, Oregon, July, 1982.
- Phillips, G. R., and R. C. Russo. *Metal Bioaccumulation in Fishes and Aquatic Invertebrates: A Literature Review*. EPA-600-3-78-103, U.S. Environmental Protection Agency, Duluth, Minnesota. December 1978.
- Pisano, W.C. and H. Brombach. "Solids settling curves: Wastewater solids data can aid design of urban runoff controls." *Water Environment & Technology*. Vol. 8, no. 4, pp. 27-33. April 1996.
- Pitt, R. and M. Bozeman. *Lake Merritt Management Plan*. City of Oakland Department of Public Works, Oakland, California, May 1979.
- Pitt, R. *Demonstration of Nonpoint Pollution Abatement Through Improved Street Cleaning Practices*, EPA-600/2-79-161, U.S. Environmental Protection Agency, Cincinnati, Ohio. 270 pgs. 1979.
- Pitt, R. and G. Shawley. *A Demonstration of Non-Point Source Pollution Management on Castro Valley Creek*. Alameda County Flood Control and Water Conservation District (Hayward, CA) for the Nationwide Urban Runoff Program, U.S. Environmental Protection Agency, Water Planning Division, Washington, D.C., June 1982.
- Pitt, R. and M. Bozeman. *Sources of Urban Runoff Pollution and Its Effects on an Urban Creek*, EPA 600/S2-82-090, U.S. Environmental Protection Agency, Cincinnati, Ohio. 1982.
- Pitt, R. and R. Sutherland. *Washoe County Urban Stormwater Management Program; Volume 2, Street Particulate Data Collection and Analyses*. Washoe Council of Governments, Reno, Nevada, August 1982.

- Pitt, R. and P. Bissonnette. *Bellevue Urban Runoff Program Summary Report*, U.S. Environmental Protection Agency, Water Planning Division. PB84 237213. Washington, D.C. 173 pgs. 1984.
- Pitt, R. *Characterizing and Controlling Urban Runoff through Street and Sewerage Cleaning*. U.S. Environmental Protection Agency, Storm and Combined Sewer Program, Risk Reduction Engineering Laboratory. EPA/600/S2-85/038. PB 85-186500. Cincinnati, Ohio. 467 pgs. June 1985.
- Pitt, R. "Runoff controls in Wisconsin's Priority Watersheds." *Advanced Topics in Urban Runoff Research* conference. Proceedings edited by B. Urbonas and L.A. Roesner. Engineering Foundation and ASCE, New York. pp. 290-313. 1986.
- Pitt, R., and J. McLean. *Toronto Area Watershed Management Strategy Study: Humber River Pilot Watershed Project*. Ontario Ministry of the Environment, Toronto, Ontario, 1986.
- Pitt, R. *Small Storm Urban Flow and Particulate Washoff Contributions to Outfall Discharges*. Ph.D. dissertation. Dept. of Civil and Environmental Engineering, the University of Wisconsin, Madison, Wisconsin. Listed in Dissertation Abstracts International, University Microfilms International, Vol. 49, No. 1, 1988. November 1987.
- Pitt, R. "Biological impacts associated with urban runoff," in: *Effects of Urban Runoff on Receiving Systems: An Interdisciplinary Analysis of Impact, Monitoring, and Management*, Engineering Foundation Conference, Mt. Crested Butte, CO. ASCE, NY. 1991.
- Pitt, R. and K. Dunkers. "Combined treatment of stormwater and lakewater in Lake Rönningesjön, Sweden." *12th Annual International Symposium, North American Lake Management Society*, Cincinnati, Ohio, November 1992.
- Pitt, R. "Detention pond design for water quality improvement." *National ASCE Hydraulic Conference*. San Francisco, California. July 1993a.
- Pitt, R. "The stormwater quality detention pond model (DETPOND)." *26th Annual Water Resources Conference*. University of Minnesota. October 1993b.
- Pitt, R. and K. Dunkers. "Lake water quality improvements from treatment of stormwater using the Flow Balancing Method." *66th Annual Water Environment Federation Conference*. Anaheim, California. October 1993.
- Pitt, R. E., Field, R. I., Lalor, M. M., Adrian, D. D., Barbe', D.. *Investigation of Inappropriate Pollutant Entries into Storm Drainage Systems: A User's Guide*. Rep. No. EPA/600/R-92/238, NTIS Rep. No. PB93-131472/AS, US EPA, Storm and Combined Sewer Pollution Control Program (Edison, New Jersey), Risk Reduction Engineering Lab., Cincinnati, Ohio. 1993.
- Pitt, R, S. Clark, and K. Parmer. *Potential Groundwater Contamination from Intentional and Non Intentional Stormwater Infiltration*. Cooperative Agreement No. CR 819573, U.S. Environmental Protection Agency, Cincinnati, Ohio. 1994.
- Pitt, R. "Biological Effects of Urban Runoff Discharges." In: *Stormwater Runoff and Receiving Systems: Impact, Monitoring, and Assessment*. (Edited by E.E. Herricks). Engineering Foundation and ASCE. CRC/Lewis. Boca Raton, pp. 127-162. 1995a.
- Pitt, R. "Water quality trends from stormwater controls." In: *Stormwater NPDES Related Monitoring Needs* (Edited by H.C. Torno). Engineering Foundation and ASCE. pp. 413-434. 1995b.
- Pitt, R. "Effects of Urban Runoff on Aquatic Biota." In: *Handbook of Ecotoxicology* (Edited by D.J. Hoffman, B.A. Rattner, G.A. Burton, Jr. and J.Cairns, Jr.). Lewis Publishers/CRC Press, Boca Raton, pp. 609-630. 1995c.
- Pitt, R. "Preliminary investigation of EquaFlow™ system for Town Lake, Austin, TX." Unpublished report prepared for Loomis and Associates and the City of Austin, TX, October 1995d.
- Pitt, R. and J. Voorhees. "Source loading and management model (SLAMM)." *Seminar Publication: National Conference on Urban Runoff Management: Enhancing Urban Watershed Management at the Local, County, and State Levels*. March 30 – April 2, 1993. Center for Environmental Research Information, U.S. Environmental Protection Agency. EPA/625/R-95/003. Cincinnati, Ohio. pp. 225-243. April 1995.
- Pitt, R., R. Field, M. Lalor, and M. Brown. "Urban stormwater toxic pollutants: Assessment, sources and treatability." *Water Environment Research*. Vol. 67, No. 3, pp. 260-275. May/June 1995.
- Pitt, R., S. Clark, K. Parmer, and R. Field. *Groundwater Contamination from Stormwater*. ISBN 1-57504-015-8. Ann Arbor Press, Inc. Chelsea, Michigan. 219 pages. 1996.
- Pitt, R. "Unique Features of the Source Loading and Management Model (SLAMM)." In: *Advances in Modeling the Management of Stormwater Impacts, Volume 6*. (Edited by W. James). Computational Hydraulics International, Guelph, Ontario and Lewis Publishers/CRC Press. pp. 13 – 37. 1997.
- Pitt, R., B. Robertson, P. Barron, A. Ayyoubi, and S. Clark. *Stormwater Treatment at Critical Areas: The Multi-Chambered Treatment Train (MCTT)*. U.S. Environmental Protection Agency. March 1999.

- Poertner, H.G. *Practices in Detention of Urban Stormwater Runoff*. American Public Works Association, OWRR Contract No. 14-31-0001-3722, Chicago, 1974.
- Pratt, C.J. "An assessment of effectiveness of a BMP strategy in urban drainage in the U.K." *Proceedings of the 6<sup>th</sup> International Conference on Urban Storm Drainage*. Edited by J. Marsalek and H.C. Torno. Niagara Falls, Ontario. September 12 - 17, 1993. IAWQ, London. Published by Seapoint Publishers, Victoria, B.C. pp. 951 - 956. 1993.
- Pratt, J. M., R. A. Coler and P. J. Godfrey. "Ecological effects of urban stormwater runoff on benthic macroinvertebrates inhabiting the Green River, Massachusetts." *Hydrobiologia*, 83, 29. 1981.
- Prych, E. A. and J. C. Ebbert. *Quantity and Quality of Storm Runoff from Three Urban Catchments in Bellevue, Washington*, Preliminary U.S. Geological Survey Water Resources Investigations Report, Tacoma, Washington. Undated.
- Pyzoha, D. *Implementing a Stormwater Management Program*. Lewis Publishers, Boca Raton, Florida, 1994.
- Rainbow, P.S. "Chapter 18: Heavy metals in aquatic invertebrates." *In: Environmental Contaminants in Wildlife: Interpreting Tissue Concentrations*. Edited by W.N. Beyer, G.H. Heinz, and A.W. Redmon-Norwood. CRC/Lewis Press. Boca Raton. pp. 405 - 425. 1996.
- Randall, C. W. "Stormwater detention ponds for water quality control." *Proceedings of the Conference on Stormwater Detention Facilities, Planning, Design, Operation, and Maintenance*, Henniker, New Hampshire, Edited by W. DeGroot, published by the American Society of Civil Engineers, New York, August 1982.
- Randall, C. W., K. Ellis, T. J. Grizzard, and W. R. Knocke. "Urban runoff pollutant removal by sedimentation." *Urban Runoff Pollutant Removal by Sedimentation*, *Proceedings of the Conference on Stormwater Detention Facilities, Planning, Design, Operation, and Maintenance*, Henniker, New Hampshire, Edited by W. DeGroot, published by the American Society of Civil Engineers, New York, August 1982.
- Richey, J. S. *Effects of Urbanization on a Lowland Stream in Western Washington*, Doctor of Philosophy dissertation, University of Washington, Seattle. 1982.
- Richey, J. S., M. A. Perkins, and K. W. Malueg. "The effects of urbanization and stormwater runoff on the food quality in two salmonid streams," *Verh. Internat. Verein. Limnol.*, 21, 812-818, Stuttgart. 1981.
- Richey, Joanne Sloane. *Effects of Urbanization on a Lowland Stream in Western Washington*. Doctor of Philosophy dissertation, University of Washington, Seattle, 1982.
- Robertson, B. *Evaluation of a Multi-Chambered Treatment Train (MCTT) for Treatment of Stormwater Runoff from Critical Pollutant Source Areas*. MSCE Thesis, Department of Civil and Environmental Engineering. University of Alabama at Birmingham. 268 pages. 1995
- Robertson, B., R. Pitt, A. Ayyoubi, and R. Field (1995) "A Multi-Chambered Stormwater Treatment Train." *In: Stormwater NPDES Related Monitoring Needs* (Edited by H.C. Torno). Engineering Foundation and ASCE. pp. #631-640.
- Roesner, L.A., B.R. Urbonas and M.B. Sonnen, editors. *Design of Urban Runoff Quality Controls*. Proceedings of an Engineering Foundation Conference on Current Practice and Design Criteria for Urban Quality Control, American Society of Civil Engineers, NY. 1989.
- Rolfe, G.L. and K.A. Reinhold. *Vol. I: Introduction and Summary. Environmental Contamination by Lead and Other Heavy Metals*. Institute for Environmental Studies, University of Illinois, Champaign-Urbana, Illinois, July 1977.
- Romano, F. *Oil and Water Don 't Mix: The Application of Oil-Water Separation Technologies in Stormwater Quality Management*. Seattle Metro. Washington. 1990.
- Rosmiller, R. *Detention Pond Workshop Notes*, University of Wisconsin-Madison, Wright Water Engineering, Denver, Colorado, 1987?.
- Rospond, F. J. "Roof detention of rainfall to limit urban runoff." *National Symposium on Urban Hydrology, Hydraulics, and Sediment Control*, University of Kentucky, Lexington, Kentucky, July, 1976.
- Rubin, A. J., ed. *Aqueous-Environmental Chemistry of Metals*. Ann Arbor Science Publishers, Ann Arbor, Michigan. 1976.
- Rupperd, Y. "A lamellar separator for urban street runoff treatment." (in French) *Bulletin de Liaison des Laboratoires des Ponts et Chaussées*, no 183, pp 85-90. 1993.
- Rutherford, J. B. "On-site multi-functional stormwater detention facilities; A case study." *International Symposium on Urban Hydrology, Hydraulics, and Sediment Control*, University of Kentucky, Lexington, Kentucky, July, 1977.
- Ryan, J. "Process selection for oil separation." *Effluent and Water Treatment Journal*. Vol. 26, pp. 60-63. 1986.

- Sartor J. and G. Boyd. *Water Pollution Aspects of Street Surface Contaminants*. EPA-R2-72-081, U.S. Environmental Protection Agency, November 1972.
- Schimmenti, F.G. "Stormwater detention basins must control more than runoff." *American City and County*, December 1980.
- Schueler, T. R. *New Guidebook Review Paper No. 2, Wet Pond BMP Design*. Metropolitan Washington Council of Governments, Washington, D.C., 1986.
- Schueler, T. *Controlling Urban Runoff: A Practical Manual for Planning and Designing Urban Best Management Practices*. Metropolitan Washington Council of Governments. 280 pgs. 1987.
- Schueler, T.R. and J. Galli. "The environmental impact of stormwater ponds." Engineering Foundation Conference: *Urban Runoff and Receiving Systems: An Interdisciplinary Analysis of Impact, Monitoring, and Management*. Mt. Crested Butte, Colorado. August 4-9, 1991. Published by the American Society of Civil Engineers, New York, June 1992.
- Schueler, T., and D. Shepp. *The Quality of Trapped Sediments and Pool Water Within Oil Grit Separators in Suburban Maryland*. Metro Washington Council of Governments. Washington, D.C. 48 pp. 1993.
- Schueler, T. (editor). "Hydrocarbon Hotspots in the Urban Landscape: Can they be Controlled?" *Watershed Protection Techniques*. Vol. 1, No. 1, pp. 3 - 5. Feb. 1994.
- Schueler, T. (editor). "Stream channel geometry used to assess land use impacts in the Pacific Northwest." *Watershed Protection Techniques*. Vol. 2, no. 2, pp. 345 - 348. Spring 1996a.
- Schueler, T. (editor). "Vegetated rock filter treats stormwater pollutants in Florida" *Watershed Protection Techniques*. Vol. 2, No. 2, pp. 372 - 374. Spring 1996b.
- Scott, J.B., C.R. Steward, and Q.J. Stober. *Impacts of Urban Runoff on Fish Populations in Kelsey Creek, Washington*. Contract No. R806387020, U.S. Environmental Protection Agency, Corvallis Environmental Research Laboratory, Corvallis, Oregon, May 1982.
- SCS (now NRCS) (U.S. Soil Conservation Service). *Computer Program for Project Formulation, Hydrology*. Technical Release Number 20 (TR-20). U.S. Dept. of Agriculture, 1982a.
- SCS (now NRCS) (U.S. Soil Conservation Service). *Ponds - Planning, Design, Construction*. Agriculture Handbook Number 590, U.S. Dept. of Agriculture, 1982b.
- SCS (now NRCS) (U.S. Soil Conservation Service). *Urban Hydrology for Small Watersheds*. Tech. Release No. 55, U.S. Dept. of Agriculture, June 1986.
- SCS (now NRCS) (U.S. Soil Conservation Service, now Natural Resources Conservation Service). *Engineering Field Manual for Conservation Practices. Chapter 11. Ponds and Reservoirs*, Compiled by G. M. Renfro, Fort Worth, Texas, undated.
- SEMCOG (Southeast Michigan Council of Governments). *Detention Basin Maintenance, Program Needs and Financing Options*. Technical Bulletin No. 3, Detroit, Michigan, May 1981.
- Shaheen, D.G. *Contributions of Urban Roadway Usage to Water Pollution*. 600/2-75-004. U.S. Environmental Protection Agency. Washington, D.C. April 1975.
- Shaver, Earl. "Sand Filter Design for Water Quality Treatment." *Proceedings from an Engineering Foundation Specialty Conference*. Crested Butte, Colorado, 1991.
- Shelley, P.E. and D.R. Gaboury. "Estimation of Pollution from Highway Runoff - Initial Results", *Conference on Urban Runoff Quality - Impact and Quality Enhancement Technology*, Henniker, New Hampshire, Edited by B. Urbonas and L.A. Roesner, Proceedings published by the American Society of Civil Engineering, New York, June 1986.
- Shen, H.W. "Some Basic Concepts on Sediment Transport in Urban Storm Drainage Systems." *Second International Conference on Urban Storm Drainage*, Urbana, Illinois, June 1981.
- Shepp, D., and D. Cole. *A Field Survey of Oil-Grit Separators in Suburban Maryland*. Metro Washington Council of Governments. Washington, D.C. 51 pp. 1992.
- Singer, M.J. and J. Blackard. "Effect of Mulching on Sediment in Runoff from Simulated Rainfall." *Soil Sci. Soc. Am. J.*, 42:481-486, 1978.
- Smith, W. G. "Water quality enhancement through stormwater detention." *Proceedings of the Conference on Stormwater Detention Facilities, Planning, Design, Operation, and Maintenance*, Henniker, New Hampshire, Edited by W. DeGroot, published by the American Society of Civil Engineers, New York, August 1982.
- Snodgrass, W.J., B.W. Kilgour, L. Leon, N. Eyles, J. Parish, and D.R. Barton. "Applying ecological criteria for stream biota and an impact flow model for evaluation sustainable urban water resources in southern Ontario." In: *Sustaining Urban Water Resources in the 21<sup>st</sup> Century*. Proceedings of an Engineering Foundation Conference.

- Edited by A.C. Rowney, P. Stahre, and L.A. Roesner. Malmö, Sweden. Sept. 7 – 12, 1997. To be published by ACSE, New York. 1998.
- Solomon, R.L., and D.F.S. Natusch. Vol:III: "Distribution and Characterization of Urban Dists." In: *Environmental Contamination by Lead and Other Heavy Metals*, G. L. Rolfe and K. G. Reinbold, eds. Institute for Environmental Studies, Univ. of Illinois, Urbana-Champaign, Illinois. July 1977.
- Spring, R. J., R. B. Howell, and E. Shirley. *Dustfall Analysis for the Pavement Storm Runoff Study* (I-405 Los Angeles). Office of Transportation Laboratory, California Dept. of Transportation, Sacramento, California. April 1978.
- Squillace, P.J., J.S. Zogorski, W.G. Wilber, and C.V. Price. "Preliminary assessment of the occurrence and possible sources of MTBE in groundwater in the United States, 1993 - 94." *Environmental Science & Technology*. Vol. 30, no. 5, pp. 1721 - 1730. May 1996.
- Stahre, P. "Assessment of BMP's being used in Scandinavia." Proceedings of the 6<sup>th</sup> *International Conference on Urban Storm Drainage*. Edited by J. Marsalek and H.C. Torno. Niagara Falls, Ontario. September 12 - 17, 1993. IAWQ, London. Published by Seapoint Publishers, Victoria, B.C. pp. 939 - 944. 1993.
- Stahre, P. and B. Urbonas. *Stormwater Detention for Drainage, Water Quality and CSO Management*. Prentice Hall. Englewood Cliffs. 340 pgs. 1990.
- Stanley, D.W. "Pollutant removal by a stormwater dry detention pond." *Water Environment Research*. Vol. 68, no. 6, pp. 1076 - 1083. Sept./Oct. 1996.
- Stephenson, D. "Evaluation of effects of urbanization on storm runoff." 7<sup>th</sup> *International Conference on Urban Storm Drainage*. Hannover, Germany. Sept. 9-13, 1996. Edited by F. Sieker and H-R. Verworn. IAHR/IAWQ. SuG-Verlagsgesellschaft. Hannover, Germany. pp. 31-36. 1996.
- Striegl, R. G. *Effects of Stormwater Runoff on an Urban Lake, Lake Ellyn at Glen Ellyn, Illinois*, USGS Open File Report 84-603, U.S. Geological Survey, Lakewood, Colorado. 1985.
- Sutherland, R., and R.H. McCuen. "Simulation of Urban Nonpoint Source Pollution." *Water Resources Bulletin*, Vol. 14, No. 2, pp 409-428, April 1978.
- Sutherland, R., W. Alley, and F. Ellis. *Draft Users' Guide for Particulate Transport Model (PTM)*. CH2M -HILL, Portland, Oregon, for the U.S. Geological Survey, undated (1982?).
- Tabakin, R.B., R. Trattner, and P.N. Cheremisinoff. "Oil water separation technology: the available options available." *Water and Sewage Works*. Vol. 125, no.8, pp. 72-75. 1978.
- Terstriep, M.L., G.M. Bender, D.C. Noel. *Nationwide Urban Runoff Project, Champaign, Illinois: Evaluation of the Effectiveness of Municipal Street Sweeping in the Control of Urban Storm Runoff Pollution*. Contract No. 1-5-39600, U.S. Environmental Protection Agency, Illinois Environmental Protection Agency, and the State Water Survey Division, University of Illinois, December 1982.
- Thanh, N.C. and U. Thipsuwan. "Oil separation from oily wastewater by inclined plates." In: *Water Pollution Control in Developing Countries, Proceedings of the International Conference*. Bangkok, Thailand, February 1978. (edited by Ouano, E.A.R., B.N. Lohani and N.C. Thanh). pp. 553-565. Pergamon Press. New York, NY. 1978.
- Tramier B. *Water Treatment Technology - IP 84-011*. Institute of Petroleum. London, England. 1983.
- Trauth, R. and C. Xanthopoulos. "Non-point pollution of groundwater in urban areas." 7<sup>th</sup> *International Conference on Urban Storm Drainage*. Hannover, Germany. Sept. 9-13, 1996. Edited by F. Sieker and H-R. Verworn. IAHR/IAWQ. SuG-Verlagsgesellschaft. Hannover, Germany. pp. 701-706. 1996.
- Van Buren, M.A., W.E. Watt, and J. Marsalek. "Enhancing the removal of pollutants by an on-stream pond." *Water Science and Technology*. Vol. 33, no. 4 - 5, pp. 325-332. 1996.
- Verschueren, K. *Handbook of Environmental Data on Organic Chemicals, 2<sup>nd</sup> edition*. Van Nostrand Reinhold Co., New York. 1983.
- Vignoles M., and L. Herremans. "Metal pollution of sediments contained in runoff water in the Toulouse city." (in French). *NOVATECH 95, 2<sup>nd</sup> International Conference on Innovative Technologies in Urban Storm Drainage*. May 30 - June 1, 1995. Lyon, France. pp. 611-614. Organized by Eurydice 92 and Graie. 1995.
- W&H Pacific. *Methods and Results Summary: Compost Storm Water Filter System*. W&H Pacific (now Stormwater Management) Portland, OR. 1992.
- Walesh, S. "Ad hoc session on quantity issues." *Proceedings of the Conference on Stormwater Detention Facilities, Planning, Design, Operation, and Maintenance*, Henniker, New Hampshire, Edited by W. DeGroot, published by the American Society of Civil Engineers, New York, August 1982.

- Water Environment & Technology*. "News Watch: Sewer separation lowers fecal coliform levels in the Mississippi River." Vol. 8, no. 11, pp. 21 - 22. Nov. 1996a.
- Water Environment & Technology*. "Research Notes: Beachgoers at Risk from Urban Runoff." Vol. 8, no. 11, pg. 65. Nov. 1996b.
- Webb C. "Separating oil from water." *The Chemical Engineer*. No. 494, pp. 19-24. 1991.
- Whipple, W. and J. V. Hunter. "Settleability of urban runoff pollution." *Journal WPCF*, Vol. 53, No. 12, pg. 1726, 1981.
- Wiegand, C., T. Schueler, W. Chittenden, and D. Jellick. "Comparative costs and cost effectiveness of urban best management practices." Engineering Foundation Conference: *Urban Runoff Quality - Impact and Quality Enhancement Technology*, Henniker, New Hampshire, edited by B. Urbonas and L. A. Roesner, published by the American Society of Civil Engineers, New York, June 1986.
- Wigington, P. J., C. W. Randall, and T. J. Grizzard. "Accumulation of selected trace metals in soils of urban runoff detention basins." *Water Resources Bulletin*, Vol. 19, No. 5, pg. 709, October 1983.
- Wilber, W.G., and J.V. Hunter. *The Influence of Urbanization on the Transport of Heavy Metals in New Jersey Streams*. Water Resources Research Institute, Rutgers University, New Brunswick, New Jersey. 1980.
- Williams, L. H. "Effectiveness of stormwater detention." *Proceedings of the Conference on Stormwater Detention Facilities, Planning, Design, Operation, and Maintenance*, Henniker, New Hampshire, Edited by W. DeGroot, published by the American Society of Civil Engineers, New York, August 1982.
- Wind, S. "Three years after - failure or success." *Land and Water*, Vol. 40, no. 6, pg. 37. Nov./Dec. 1996.
- WWC (Woodward-Clyde Consultants). *Evaluation of Existing Stormwater Pump Stations in Santa Clara County for Pollution Control Potential*. Prepared for Santa Clara Valley Water District. July 1990.
- Woodward-Clyde Consultants. *Sunnyvale Detention Basin Demonstration Project*. Prepared for Santa Clara Valley Nonpoint Source Pollution Control Program. November 1994.
- Yalin, M.S. "An Expression for Bed Load Transportation." *Journal of the Hydraulics Division*, Proceedings of the American Society of Civil Engineers, Vol 89, pp 221-250, 1963.
- Yousef, Y. A., M. P. Wanielista, and H. H. Harper. "Design and effectiveness of urban retention basins." *Engineering Foundation Conference: Urban Runoff Quality - Impact and Quality Enhancement Technology*, Henniker, New Hampshire, edited by B. Urbonas and L. A. Roesner, published by the American Society of Civil Engineers, New York, June 1986.
- Yousef, Y.A. and L.Y. Lin. "Toxicity of bottom sediments in detention ponds." *Environmental Engineering: Proceedings of the 1990 Specialty Conference*. pp. 809 - 816. American Society of Civil Engineering, New York. 1990.
- Yu, S.L., S-L. Liao, G.M. Fitch, and S. Long. "Constructed wetlands for stormwater management." *69<sup>th</sup> Annual Water Environment Federation Technical Exposition and Conference (WEFTEC)*. Dallas, TX. Water Environment Federation, Alexandria, VA. Vol. 7, parts I, II, and III. pp. 167-178. 1996.
- Zogorski, J.S., A.B. Morduchowitz, A.L. Baehr, B.J. Bauman, D.L. Conrad, R.T. Drew, N.E. Korte, W.W. Lapham, J.F. Pankow, and E.R. Washington. *Fuel Oxygenates and Water Quality: Current Understanding of Sources, Occurrence in Natural Waters, Environmental Behavior, Fate, and Significance*. Office of Science and Technology, Washington, D.C. 91 pgs. 1996.
- Zukovs, G. *Development of a Probabilistic Runoff Storage/Treatment Model*. Master of Engineering Thesis, University of Toronto, 1983.

## Appendix A: User Guide for DETPOND

The following example shows the initial steps in designing a wet detention pond and the development of a DETPOND file for that pond in order to enable water quality evaluations. The pond sizing criteria can be examined in relation to site constraints and the pond design modified, if needed, based on these evaluations.

### Example Design Calculations and Evaluation Using DETPOND

The following discussion presents a calculation example using the design criteria presented earlier:

- Assume a medium density residential area of 150 acres with a goal of approximately 90% suspended solids control (corresponding to 5 $\mu$ m critical particle size).
- The wet pond surface would therefore be:  $0.008(150 \text{ acres}) = 1.2 \text{ acres}$
- The runoff volume for 1.25" rain  $\Rightarrow$  0.5" runoff (based on typical development conditions and small storm hydrology; CN= 90 and Rv= 0.4).
- Therefore, wet storage volume:  $0.5"(150 \text{ acres}) \Rightarrow 6.3 \text{ acre-feet}$
- The depth associated with the wet storage volume can be estimated assuming a prismatic cross-section (simplified, compared to a conical section):

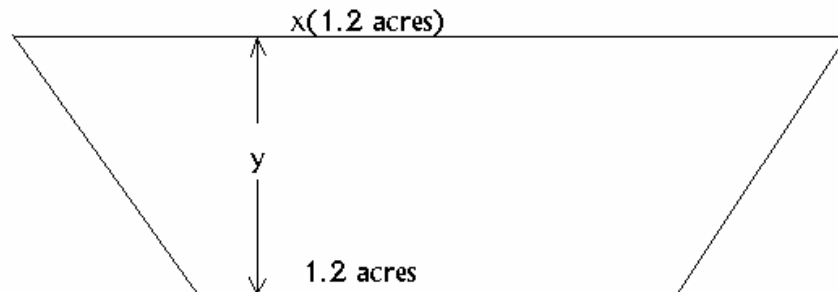

Approximately:  $[1.2 + x(1.2)]y/2 = 6.3 \text{ acre-ft.}$

re-arranging gives:  $x = [(10.5)/y] - 1$

The following table can be used to give simultaneous depths for different x multipliers and top of pond areas for the “live-storage” area of the pond (the section affected by the primary water quality outlet device and located on top of the permanent pool depth, and below the invert of the emergency spillway and additional storage needed for flood control):

y (depth, ft)	x (multiplier)	top area
2	4.3	4.3 (1.2 acres) = 5.2 acres
3	2.5	3.0 acres
4	1.6	1.9 acres
5	1.1	1.3 acres



Depths less than 2 feet are too shallow and could require very large pond top surface areas for this example. “Live depths” greater than 5 feet may be too deep for most locations and obviously result in very steep side slopes for this example.

The following table summarizes the calculations for the side slopes of the pond (assuming a simple circular shaped pond, as shown below):

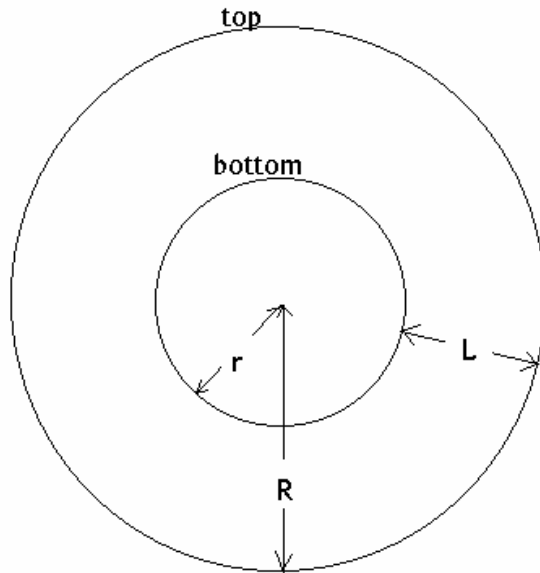

$$r = (A/\pi)^{1/2} = [1.2 \text{ acres}(43,560 \text{ ft}^2 \text{ per acre})/\pi]^{1/2} = 130 \text{ ft}$$

Depth (ft)	Top Area (acres)	Top Radius (ft)	Slope Length (ft)	Side Slope
2	5.2	270	270 - 130 = 140	2/140 = 1.4%
3	3.0	200	200 - 130 = 70	3/70 = 4.3%
4	1.9	160	160 - 130 = 30	4/30 = 13%
5	1.3	135	135 - 130 = 5	5/5 = 100%

- The preliminary pond cross-section is therefore:

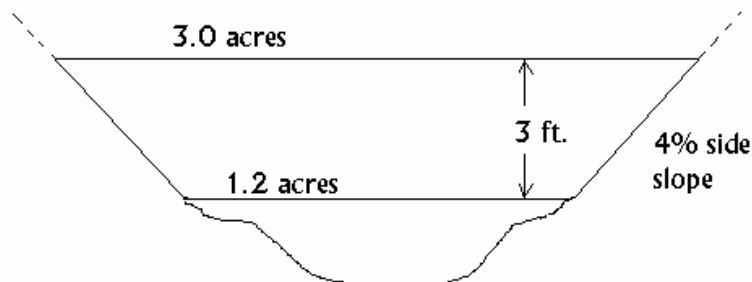

- The outfall device is selected by comparing the maximum allowable discharge rate for the surface area of the pond at several pond depth increments. These maximum allowable discharges are compared with weir ratings (as tabulated in the text, for example) to select the permissible weirs that can be used:

$$Q_{out} = vA$$

$$v = 1.3 \times 10^{-4} \text{ ft/sec for } 5 \text{ } \mu\text{m particle}$$

Stage (above normal water surface, ft)	Pond Area (acres)	Maximum Allowable Discharge (cfs)
0	1.2	6.8
0.5	1.5	8.5
1	1.8	10
1.5	2.1	12
2	2.4	14
3	3.0	17 (usually most critical)

Therefore, use a single 45° V-notch weir, or two 22-1/2° V-notch weirs.

- Select emergency spillway (mandatory) and additional flood control storage volume (if necessary) using NRCS TR-55 (SCS 1986) procedures.

- Figure A-1 is an example program check sheet for a DETPOND model evaluation, while the next section shows how this information is entered into a data file for analysis.

Figure A-1a. DETPOND model check sheet for example calculation.

150 acres MDR "90%" control  
 $n=5$   
 medium. cp 2  
 (from 76 + from Flood)  
 Wet Detention Ponds W

directly connected impervious 45 acres (30%)  
 pervious 75 acres (50%)  
 impervious areas draining to pervious 30 acres (20%)  
 150 acres

Diagram Outlet Structures in space below

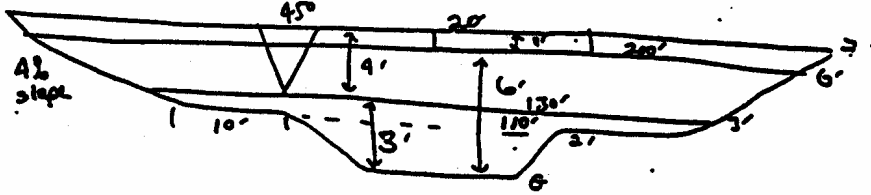

1. Initial stage elevation (ft) above datum: 3
2. Number of stage elevation increments required: (constant 0.5 ft by 1/2")
3. Total number of outlets (10 max): 2
4. Stage, pond area, seepage, and other outlet information:

Entry Number	Stage (ft)	Pond Area (Acres)	Natural Seepage (cfs)	Other Outflow (cfs)
0	0	* 0	/	/
1	0.5	0.1	/	/
2	1	0.13	/	/
3	1.5	0.17	/	/
4	2	0.2	/	/
5	2.5	0.3	/	/
6	3	0.7	/	/
7	3.5	1.5	/	/
8	4	1.8	/	/
9	4.5	2.1	/	/
10	5	2.4	/	/
11	5.5	2.7	/	/
12	6	3.0	/	/
13	6.5	3.3	/	/
14	7	3.6	/	/
15			/	/
16			/	/
17			/	/
18			/	/
19			/	/
20			/	/
21			/	/
22			/	/

Figure A-1b. DETPOND model check sheet for example calculation.

**Wet Detention Ponds (continued)**

**5. Other outlet characteristics**

**1. Rectangular Weir**

1. Weir length (ft): 20'
2. Height from bottom of weir opening (invert) to top of weir: 1'
3. Height from datum to bottom of weir opening (invert) (ft): 6'

**2. V-Notch Weir Characteristics:**

**A) Weir angle:**

1. 22.5 degrees
2. 30 degrees
3. 45 degrees
4. 60 degrees
5. 90 degrees
6. 120 degrees

**B) Height from bottom of weir opening (invert) to top of weir: 4'**

**C) Height from datum to bottom of weir opening (invert) (ft): 3'**

**3. Orifice characteristics:**

1. Orifice diameter (ft): \_\_\_\_\_
2. Invert elevation above datum (ft): \_\_\_\_\_

**4. Seepage Basin characteristics:**

1. Infiltration rate (inches/hr): \_\_\_\_\_
2. Width of device (ft): \_\_\_\_\_
3. Length of device (ft): \_\_\_\_\_
4. Invert elevation of seepage basin inlet above datum (ft): \_\_\_\_\_

**5. Monthly Evaporation Rate**

Month Number	Month	Evaporation (in/day)
1	January	_____
2	February	_____
3	March	_____
4	April	_____
5	May	_____
6	June	_____
7	July	_____
8	August	_____
9	September	_____
10	October	_____
11	November	_____
12	December	_____

## *Steps in Entering Data for Evaluation in DETPOND*

Enter the main DETPOND program by double-clicking on the WinDetpond.exe file located in the directory where the program was installed, or select the file from the “start, programs, WinDetpond” list. The following window will open:

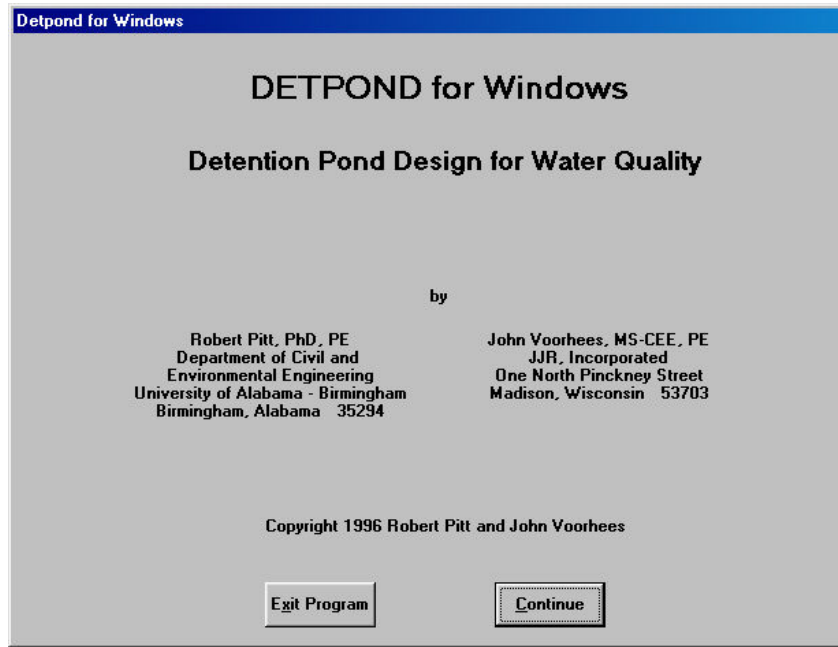

Select the “continue” button to open the following window:

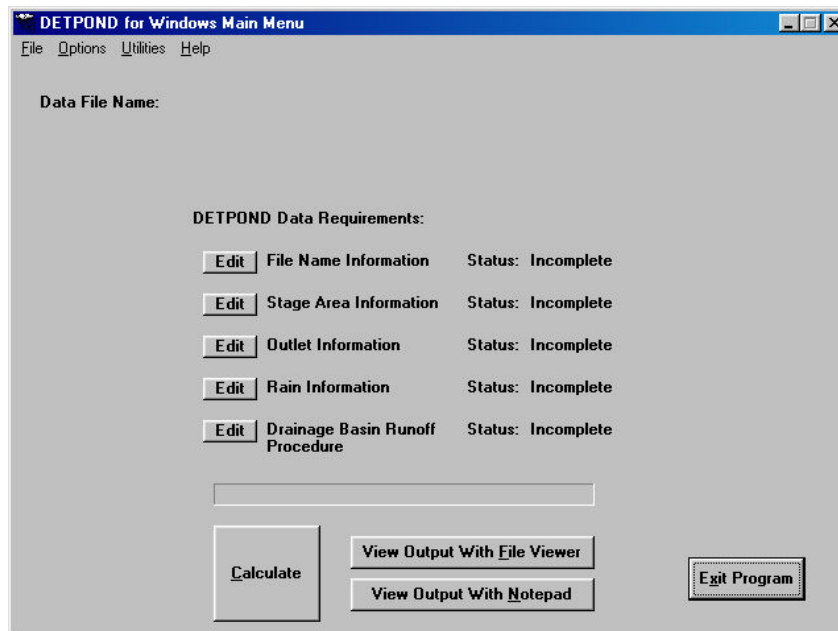

Notice that the status for each of the four main categories are listed as “incomplete.” The next steps in creating the file include entering this data. The first step for this window is to select the file name “edit” box and entering a file name, as shown below:

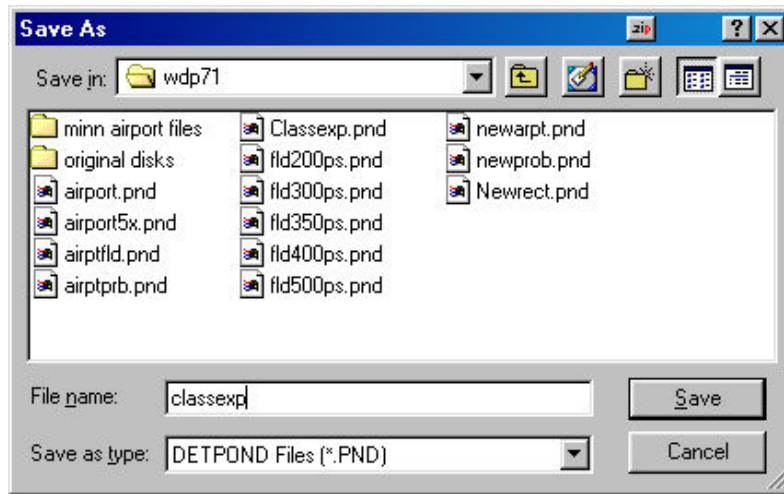

After the file name is typed in, click on the save button, after ensuring that the correct directory is listed. The next step under “file name information” is to enter a site description. Any short statement can be entered that will enable tracking the files or the site test conditions. The last part of this element is selecting the particle size file, as shown below:

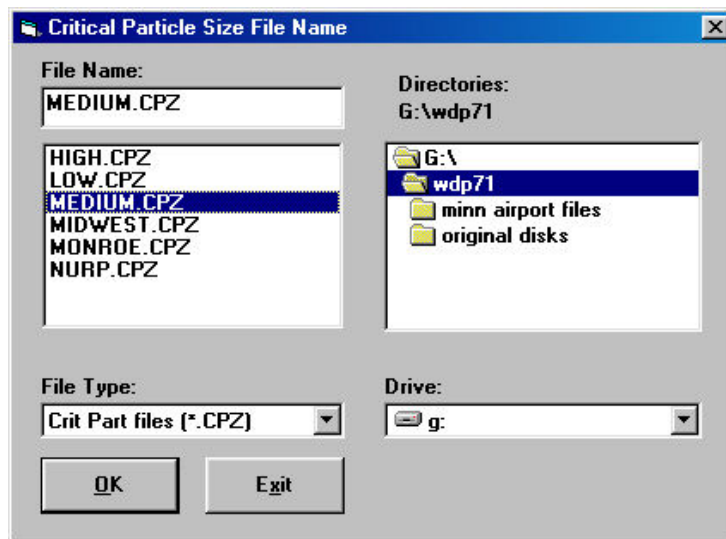

All available particle size files are listed. If the desired file is not listed, check the directory to ensure that the correct directory is shown. When the desired file is selected, click “OK.”

The next major category of information is the stage-area values. When that “edit” box is selected, the following window is displayed:

**Stage Area Values**

Initial Stage Elevation (ft)

Row 1 Stage (ft)

Insert a row before row number:

Delete row number:

User Defined Pond Efficiency Factor, n:

	Stage (ft)	Area (acres)
0	0.00	0.000
1		

Use Shift plus the arrow keys to move through the grid

The first information to be entered is the initial stage elevation. This is the water depth in the pond at the beginning of the study period. It is generally the normal water elevation (above the pond bottom datum). However, it can be different reflecting actual conditions (such as being lower than the lowest invert because of evaporation that may have occurred during an extended dry period, or higher because the pond has not completely drained since the preceding rain). When that number is entered, the program automatically starts requesting stage and surface area data. The bottom-most stage (at depth zero) is already entered (required to have a surface area of zero acres). When all of the stage-area data is entered, select continue, or change the user defined pond efficiency factor first. The sequence is displayed in the following window:

**Stage Area Values**

Initial Stage Elevation (ft)

Row 7 Area

Insert a row before row number:

Delete row number:

User Defined Pond Efficiency Factor, n:

	Stage (ft)	Area (acres)
0	0.00	0.000
1	0.50	0.100
2	1.00	0.130
3	1.50	0.170
4	2.00	0.200
5	2.50	0.900
6	3.00	1.200
	3.50	

Use Shift plus the arrow keys to move through the grid

The “User Defined Pond Efficiency Factor, n” is given as 5, but can be changed by over-typing. This is the n factor used in the Hazen equation and is equivalent to the number of pond cells. Large numbers imply very little short-circuiting, while small numbers imply that substantial numbers of large particles may be leaving the pond.

The next major data requirement group is the outlet information. Select “edit” to bring up the following window (this one has the rectangular weir already listed, normally, this would be empty and the user would select the desired outlet):

**Outlet Devices**

Add Outlet

Outlet Options

- 1. Rectangular Weir
- 2. V - Notch Weir
- 3. Orifice
- 4. Seepage Basin
- 5. Natural Seepage
- 6. Evaporation
- 7. User Specified
- 8. Pumped Outlet

Selected Outlets (Max. 10)  
Double Click to Edit or Delete

Rectangular Weir

Continue

When the rectangular weir is selected, the following window is brought up to enable the user to describe the weir dimensions and location:

**Rectangular Weir**

1. Weir Length (ft)

2. Height from bottom of weir opening (invert) to top of weir (ft)

3. Height from datum to bottom of weir opening (ft)

Cancel Continue Delete

The user needs to refer to the diagram (on Figure A-1) to ensure that the weir heights are correct. The program also checks to make sure that the sum of the “height of bottom of weir opening to top of weir” plus the “height from datum to bottom of weir opening” adds up to equal the total depth of the pond entered previously. After entering the data and clicking on “continue”, the user selects the V-notch weir for this example, bringing up the following window:



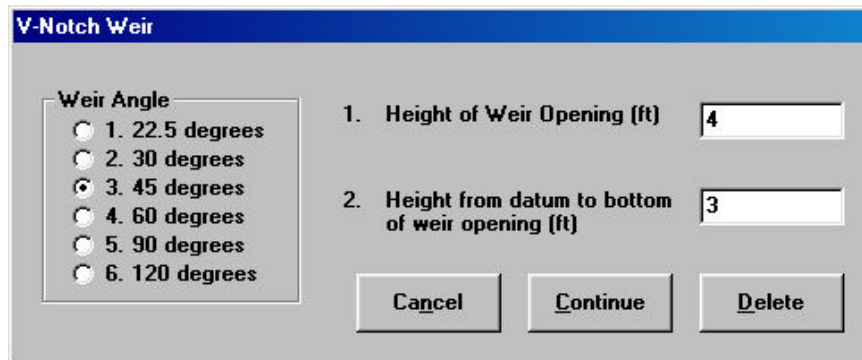

**V-Notch Weir**

**Weir Angle**

- 1. 22.5 degrees
- 2. 30 degrees
- 3. 45 degrees
- 4. 60 degrees
- 5. 90 degrees
- 6. 120 degrees

1. Height of Weir Opening (ft)

2. Height from datum to bottom of weir opening (ft)

The user selects the v-notch weir angle and the height data, and then clicks “continue.”

The next data requirement set relates to the rain file. A rainfall series is selected from the available list, and the starting and ending dates contained in the file are automatically listed. If these dates are not correct, they can be edited by selecting the “edit” button near each date, as shown in the following window, and typing in the desired dates:

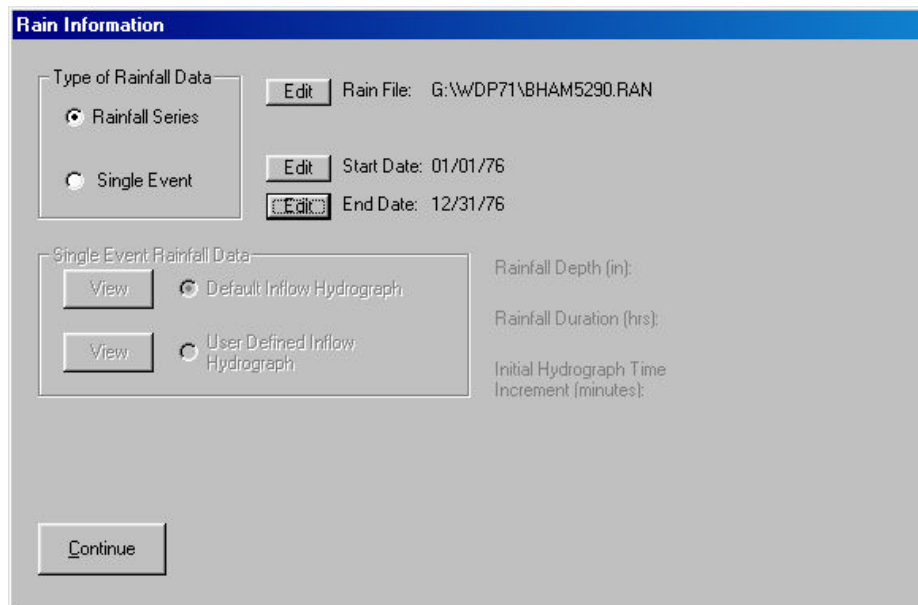

**Rain Information**

Type of Rainfall Data

- Rainfall Series
- Single Event

Rain File: G:\WDP71\BHAM5290.RAN

Start Date: 01/01/76

End Date: 12/31/76

Single Event Rainfall Data

- Default Inflow Hydrograph
- User Defined Inflow Hydrograph

Rainfall Depth (in):

Rainfall Duration (hrs):

Initial Hydrograph Time Increment (minutes):

If a user-defined hydrograph is to be evaluated (such as for entering a single design storm calculated using TR-55, for example, or to enter actual observed inflow rates), then the “single event” type of rainfall data is selected and the program prompts for that information.

The last series of data requirements is the drainage basin information, as shown in the following window:

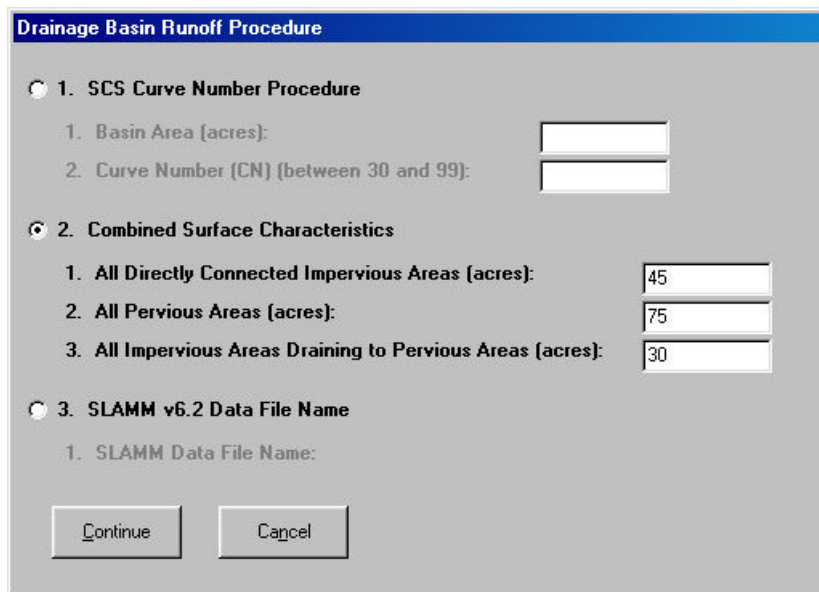

In our example, the “combined surface characteristics” is selected, which uses the correct runoff characteristics associated with small and intermediate-sized events. The area associated with each surface category is entered, and then the “continue” button is clicked. The “SCS Curve Number Procedure” simply uses a constant curve number for each event, but still uses the basic triangular hydrograph (and not the TR-55 tabular hydrograph, which is not accurate for these smaller rains). The SLAMM data file option allows more resolution in describing the surface areas, and is especially helpful if the same file is being used for a SLAMM analysis, but the greater detail in DETPOND is desired for an outfall wet detention pond. When these data are entered, the main screen shows that the status of each data requirement category is “complete.” The file needs to be saved again, as shown in the following window:

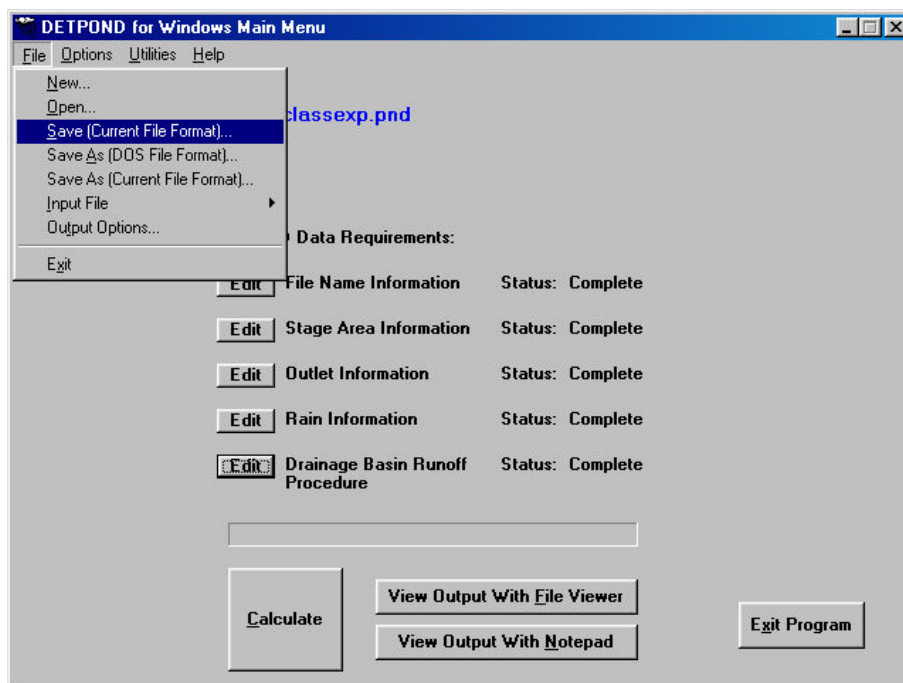

The file name is verified by clicking on “OK” in the following dialog box:



Finally, the large “calculate” button is clicked and after a few seconds, the program is completed. The file viewer is then clicked and the output file is selected. The following window then appears:

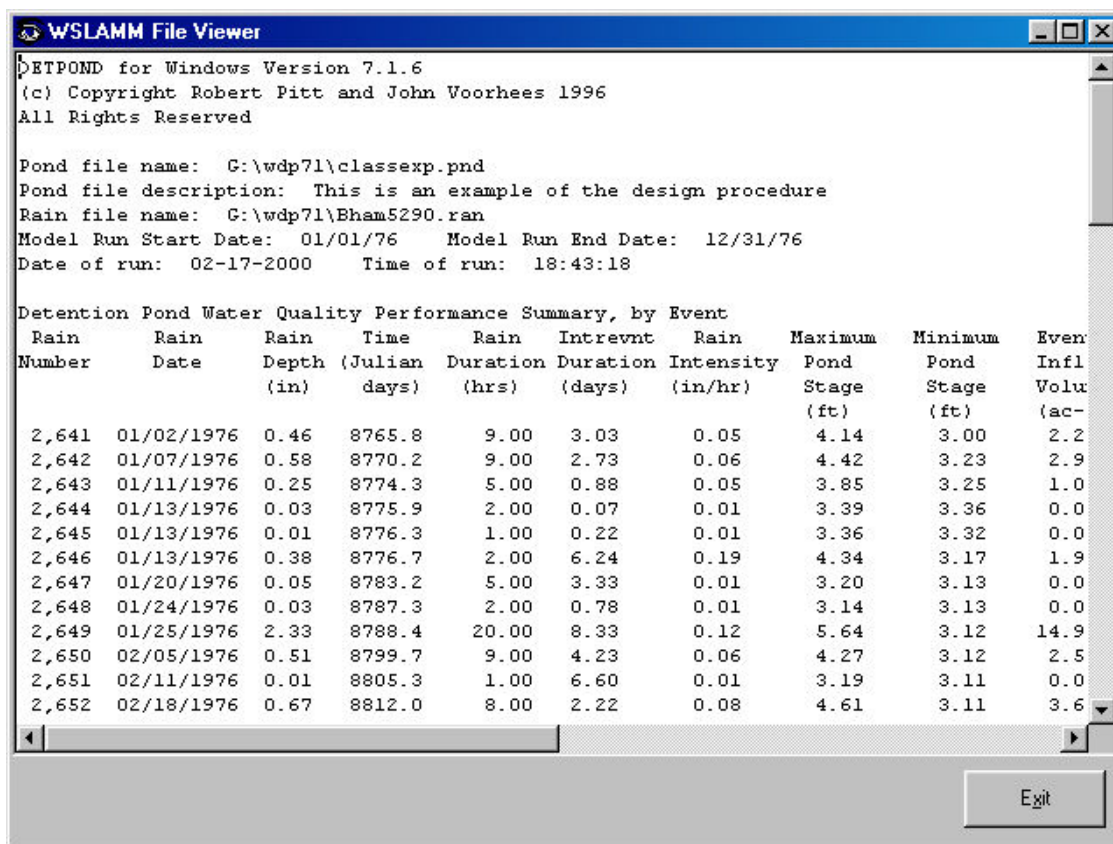

This example shows the default file output format, or one line per event. The “file, output” drop down menu offers several other options. The file is automatically saved as a comma separated value (CSV) file that can be directly opened with a spreadsheet program. In addition, the input file can also be saved to a file that can be opened in a spreadsheet for examination. The input file for this example is shown as Table A-1, while the output file (after adding some column statistics in Excel) is shown in Table A-2. It is also possible to plot these data from within the spreadsheet, or in any graphing program.

**Table A-1. Input File Associated with Example Problem**

Pond file name: G:\WDP71\CLASSEXP.PND  
Pond file description: This is an example of the design procedure  
Particle Size file name: G:\WDP71\MEDIUM.CPZ  
Output Format Option: Water Quality Summary: One Line per Event  
Output device: Print Output to File (extension .DPO)  
Date: 02-17-2000

Drainage Basin Runoff Procedure:

Combined Surface Characteristics

1. All directly connected impervious areas (acres): 45
2. All pervious areas (acres): 75
3. All impervious areas draining to pervious areas (acres): 30

Outlet Characteristics:

Outlet number 1

Outlet type: V - Notch Weir

1. Weir angle (degrees): 45
2. Weir height from invert: 4
3. Invert elevation above datum (ft): 3

Outlet Characteristics:

Outlet number 2

Outlet type: Rectangular Weir

1. Weir length (ft): 20
2. Weir height from invert: 1
3. Invert elevation above datum (ft): 6

Initial stage elevation (ft): 3

User defined pond efficiency factor (n): 5

Pond Stage, Surface Area, and Stage-related Outfall Devices (if applicable)

Entry Number	Stage (ft)	Pond Area (acres)	Natural Seepage (in/hr)	Other Outflow (cfs)
0	0.00	0.0000	0.00	0.00
1	0.50	0.1000	0.00	0.00
2	1.00	0.1300	0.00	0.00
3	1.50	0.1700	0.00	0.00
4	2.00	0.2000	0.00	0.00
5	2.50	0.9000	0.00	0.00
6	3.00	1.2000	0.00	0.00
7	3.50	1.5000	0.00	0.00
8	4.00	1.8000	0.00	0.00
9	4.50	2.1000	0.00	0.00
10	5.00	2.4000	0.00	0.00
11	5.50	2.7000	0.00	0.00
12	6.00	3.0000	0.00	0.00
13	6.50	3.3000	0.00	0.00
14	7.00	3.6000	0.00	0.00

Rain Information

Rain file name: G:\wdp71\BHAM5290.RAN

Rain starting date : 01/01/76

Rain ending date : 12/31/76

**Table A-2. Output Data for Example Analysis (one-line per event)**

DETPOND for Windows Version 7.1.6																	
© Copyright Robert Pitt and John Voorhees 1996																	
All Rights Reserved																	
Pond file name: G:\wdp71\classexp.pnd																	
Pond file description: this is an example of the design procedure																	
Rain file name: G:\wdp71\bham5290.ran																	
Model Run Start Date: 01/01/76 Model Run End Date: 12/31/76																	
Date of run: 02-17-2000 Time of run: 18:43:18																	
Detention Pond Water Quality Performance Summary, by Event																	
Rain Number	Rain Date	Rain Depth (in)	Rain Time (Julian days)	Rain Dur. (hrs)	Rain Intrvnt. Dur. (days)	Rain Intensity (in/hr)	Maximum Pond Stage (ft)	Minimum Pond Stage (ft)	Event Inflow Volume (ac-ft)	Event Hydr Outflow (ac-ft)	Event Infil Outflow (ac-ft)	Event Evap Outflow (ac-ft)	Event Total Outflow (ac-ft)	Flow-weighted Particle Size	Approx. Part Res Control (%)	Peak Reduction Factor	Event Flushing Ratio
2,641	1/17/76	0.46	8765.8	9	3.03	0.05	4.14	3.00	2.24	1.948	0	0	1.948	1.1	97.7	0.72	2.074
2,642	1/17/76	0.58	8770.2	9	2.73	0.06	4.42	3.23	2.931	2.906	0	0	2.906	1.5	96.2	0.63	2.714
2,643	1/11/76	0.25	8774.3	5	0.88	0.05	3.85	3.25	1.089	0.879	0	0	0.879	0.6	99.3	0.84	1.008
2,644	1/13/76	0.03	8775.9	2	0.07	0.01	3.39	3.36	0.017	0.068	0	0	0.068	0.2	99.8	0.39	0.015
2,645	1/13/76	0.01	8776.3	1	0.22	0.01	3.36	3.32	0.002	0.052	0	0	0.052	0.1	99.9	N/A	0.002
2,646	1/13/76	0.38	8776.7	2	6.24	0.19	4.34	3.17	1.939	2.122	0	0	2.122	1.7	95.3	0.89	1.795
2,647	1/20/76	0.05	8783.2	5	3.33	0.01	3.2	3.13	0.046	0.09	0	0	0.09	0	100	0.91	0.043
2,648	1/24/76	0.03	8787.3	2	0.78	0.01	3.14	3.13	0.017	0.016	0	0	0.016	0	100	0.95	0.015
2,649	1/25/76	2.33	8788.4	20	8.33	0.12	5.64	3.12	14.977	14.99	0	0	14.99	3.3	88.8	0.22	13.868
2,650	2/5/76	0.51	8799.7	9	4.23	0.06	4.27	3.12	2.523	2.427	0	0	2.427	1.3	96.9	0.68	2.336
2,651	2/11/76	0.01	8805.3	1	6.6	0.01	3.19	3.11	0.002	0.112	0	0	0.112	0	100	0.54	0.002
2,652	2/18/76	0.67	8812	8	2.22	0.08	4.61	3.11	3.678	3.444	0	0	3.444	1.7	95.3	0.63	3.405
2,653	2/21/76	0.61	8815.5	3	12.59	0.2	4.79	3.10	3.318	3.511	0	0	3.511	2.2	93.1	0.8	3.072
2,654	3/5/76	0.85	8828.5	23	0	0.04	4.47	3.10	4.801	4.465	0	0	4.465	1.7	95.2	0.36	4.445
2,655	3/8/76	1.11	8831.7	17	0.91	0.07	4.85	3.31	6.224	6.283	0	0	6.283	2.2	93.3	0.36	5.763
2,656	3/12/76	0.3	8835.1	5	0	0.06	4.01	3.31	1.366	0.642	0	0	0.642	1.2	97.6	0.81	1.265
2,657	3/12/76	1.18	8835.6	4	1.82	0.29	5.77	3.37	6.892	7.52	0	0	7.52	3.2	89.3	0.62	6.382
2,658	3/15/76	3.64	8838	27	1.24	0.13	6.02	3.24	25.319	25.319	0	0	25.319	3.8	86.7	0.12	23.268
2,659	3/20/76	0.04	8843.3	2	0.2	0.02	3.26	3.24	0.029	0.031	0	0	0.031	0.1	99.9	0.88	0.027
2,660	3/20/76	1.14	8843.8	6	2.93	0.19	5.4	3.24	6.616	6.576	0	0	6.576	2.8	90.8	0.58	6.126
2,661	3/24/76	0.04	8847.7	6	0.81	0.01	3.27	3.21	0.029	0.102	0	0	0.102	0.1	99.9	0.6	0.027
2,662	3/26/76	1.56	8849.4	17	0.62	0.09	5.22	3.21	9.111	8.928	0	0	8.928	2.7	91.1	0.31	8.436
2,663	3/29/76	2.2	8852.5	12	0	0.18	5.93	3.35	13.098	11.551	0	0	11.551	3.8	86.6	0.33	12.128
2,664	3/30/76	2.09	8853.4	22	8.99	0.09	5.44	3.11	12.884	14.718	0	0	14.718	3	89.8	0.2	11.911
2,665	4/11/76	0.21	8865.7	5	1.42	0.04	3.67	3.11	0.878	0.618	0	0	0.618	0.4	99.6	0.89	0.813
2,666	4/13/76	0.05	8867.9	7	9.74	0.01	3.32	3.1	0.046	0.32	0	0	0.32	0.1	99.9	0.56	0.043
2,667	4/24/76	0.84	8878.7	9	3.9	0.09	4.78	3.11	4.528	4.388	0	0	4.388	2	94.1	0.58	4.192

2,668	4/30/76	0.09	8883.9	8	0	0.01	3.31	3.21	0.165	0.055	0	0	0.055	0.1	99.9	0.87	0.153
2,669	4/30/76	0.94	8884.6	11	4.31	0.09	4.88	3.19	5.245	5.374	0	0	5.374	2.2	93.3	0.48	4.856

**Table A-2. Output Data for Example Analysis (one-line per event) (cont.)**

Rain Number	Rain Date	Rain Depth (in)	Time (Julian days)	Rain Dur. (hrs)	Intrvnt. Dur. (days)	Rain Intensity (in/hr)	Maximum Pond Stage (ft)	Minimum Pond Stage (ft)	Event Inflow Volume (ac-ft)	Event Hydr Outflow (ac-ft)	Event Infil Outflow (ac-ft)	Event Evap Outflow (ac-ft)	Event Total Outflow (ac-ft)	Flow-weighted Particle Size	Approx. Part Res Control (%)	Peak Reduction Factor	Event Flushing Ratio
2,670	5/6/76	1.71	8890.5	15	0	0.11	5.44	3.19	10.482	8.863	0	0	8.863	3.3	88.8	0.32	9.705
2,671	5/7/76	0.03	8891.5	2	0.07	0.01	4.19	3.8	0.017	0.723	0	0	0.723	1.5	96.3	N/A	0.015
2,672	5/8/76	0.3	8891.9	8	1.34	0.04	4.17	3.34	1.386	2.109	0	0	2.109	1.1	97.6	0.56	1.283
2,673	5/10/76	0.06	8894.5	2	0.03	0.03	3.37	3.33	0.067	0.052	0	0	0.052	0.2	99.8	0.87	0.062
2,674	5/10/76	0.2	8894.8	6	1.68	0.03	3.78	3.29	0.832	0.905	0	0	0.905	0.5	99.5	0.8	0.77
2,675	5/13/76	3.83	8897.4	34	0	0.11	5.86	3.3	26.954	25.826	0	0	25.826	3.8	86.8	0.11	24.958
2,676	5/15/76	0.01	8899.4	1	0.68	0.01	4	3.54	0.002	0.784	0	0	0.784	1.2	97.8	N/A	0.002
2,677	5/16/76	0.07	8900.2	2	6.24	0.04	3.57	3.15	0.092	0.633	0	0	0.633	0.3	99.7	0.73	0.085
2,678	5/22/76	2.33	8906.8	25	0.21	0.09	5.47	3.15	15.033	14.822	0	0	14.822	3.1	89.5	0.19	13.919
2,679	5/26/76	0.02	8910.7	4	0.15	0.02	3.31	3.26	0.007	0.068	0	0	0.068	0.1	99.9	N/A	0.007
2,680	5/27/76	0.02	8911.5	1	0.43	0.02	3.27	3.24	0.007	0.039	0	0	0.039	0.1	99.9	0.74	0.007
2,681	5/28/76	0.23	8912	8	0	0.03	3.77	3.24	0.994	0.522	0	0	0.522	0.7	99.3	0.79	0.92
2,682	5/28/76	0.05	8912.9	3	3.05	0.02	3.56	3.22	0.046	0.548	0	0	0.548	0.3	99.7	0.2	0.043
2,683	6/1/76	0.48	8916.4	10	15.5	0.05	4.26	3.08	2.488	2.655	0	0	2.655	1.3	96.8	0.63	2.304
2,684	6/18/76	0.03	8933.4	1	0.6	0.03	3.1	3.08	0.017	0.005	0	0	0.005	0	100	0.99	0.016
2,685	6/19/76	1.78	8934.1	24	7.4	0.07	5.15	3.1	10.778	10.74	0	0	10.74	2.7	91.1	0.23	9.98
2,686	6/30/76	0.46	8945.1	3	3.63	0.15	4.4	3.13	2.414	2.256	0	0	2.256	1.6	95.5	0.85	2.235
2,687	7/4/76	1.17	8949.2	14	7.19	0.08	5	3.14	6.626	6.751	0	0	6.751	2.4	92.4	0.4	6.136
2,688	7/13/76	0.26	8958.5	1	2.89	0.26	3.88	3.14	1.163	0.99	0	0	0.99	0.9	98.9	0.97	1.077
2,689	7/16/76	0.03	8961.5	1	4.81	0.03	3.27	3.14	0.017	0.175	0	0	0.175	0.1	99.9	0.88	0.016
2,690	7/21/76	0.09	8966.5	1	1.89	0.09	3.26	3.14	0.164	0.1	0	0	0.1	0.1	99.9	0.99	0.152
2,691	7/23/76	0.26	8968.5	1	3.81	0.26	3.92	3.19	1.163	1.109	0	0	1.109	1	98.5	0.96	1.077
2,692	7/27/76	0.91	8972.5	2	0.07	0.46	5.43	3.23	5.207	3.302	0	0	3.302	3.2	89.1	0.82	4.821
2,693	7/27/76	0.1	8972.9	1	0.31	0.1	4.37	3.83	0.216	1.182	0	0	1.182	1.9	94.4	0.48	0.2
2,694	7/28/76	1.63	8973.3	6	0.35	0.27	6.06	3.69	9.856	10.094	0	0	10.094	3.6	87.5	0.46	9.126
2,695	7/29/76	0.17	8974.6	3	0.18	0.06	3.94	3.63	0.615	0.702	0	0	0.702	1	98.5	0.78	0.569
2,696	7/30/76	0.23	8975.2	3	0.76	0.08	4.06	3.49	0.947	1.173	0	0	1.173	1.1	97.8	0.81	0.877
2,697	7/31/76	0.07	8976.4	1	6.02	0.07	3.54	3.15	0.091	0.556	0	0	0.556	0.3	99.7	0.88	0.085
2,698	8/6/76	0.3	8982.6	2	0.57	0.15	3.99	3.16	1.392	0.826	0	0	0.826	1.1	98.1	0.93	1.289
2,699	8/7/76	0.54	8983.5	1	7.93	0.54	4.89	3.14	2.849	3.31	0	0	3.31	2.6	91.6	0.91	2.638
2,700	8/15/76	0.06	8991.5	3	0.47	0.02	3.19	3.14	0.066	0.027	0	0	0.027	0	100	0.96	0.061
2,701	8/16/76	0.93	8992.5	3	7.63	0.31	5.34	3.15	5.323	5.297	0	0	5.297	2.9	90.2	0.76	4.929
2,702	8/24/76	0.86	9000.5	11	1.23	0.08	4.76	3.15	4.763	4.502	0	0	4.502	1.9	94.3	0.52	4.41
2,703	8/27/76	0.34	9003.4	6	0	0.06	4.11	3.34	1.621	0.891	0	0	0.891	1.4	96.8	0.76	1.5
2,704	8/28/76	0.11	9004	4	0	0.03	3.84	3.69	0.28	0.471	0	0	0.471	0.9	99	0.52	0.259
2,705	8/28/76	0.17	9004.4	2	0.87	0.09	3.97	3.47	0.599	0.947	0	0	0.947	1	98.4	0.84	0.554
2,706	8/29/76	0.03	9005.6	1	2.47	0.03	3.47	3.24	0.017	0.351	0	0	0.351	0.2	99.8	0.53	0.016
2,707	9/1/76	1.41	9008.2	10	0.71	0.14	5.44	3.24	8.393	8.109	0	0	8.109	2.9	90.5	0.43	7.771
2,708	9/3/76	0.25	9010.4	7	0	0.04	3.92	3.44	1.097	0.763	0	0	0.763	1	98.6	0.73	1.016



CCV	1.35	1.02	1.19	1.18	0.20	0.05	1.57	1.55	na	na	1.55	0.94	0.04	0.40	1.57
median:	0.24	5.00	1.39	0.05	3.96	3.19	1.04	0.90	0.00	0.00	0.90	1.00	98.45	0.68	0.97
total:	55.15	742	265				314	314	0.00	0.00	314				291
number:	98														



**Example 1: Create a Rain File for Use in DETPOND**

Create a rain file with the following four rainfall events:

```
01/14/87 11:00 01/15/87 03:00 0.21
01/16/87 14:00 01/16/87 16:00 0.05
01/17/87 18:00 01/19/87 02:00 3.79
01/21/87 21:00 01/22/87 07:00 0.46
```

Step Number	Command or Model Parameter	Enter Value:
1	Run the parameter module	DPPARA55
2	Select option 1: Rain data files	1
3	Select option 1: Create a rain file	1
4	Enter the number of rain events	4
5	Enter the last two digits of the year of the rain events	87
6	Enter the beginning date for the first event in the format MMDD	0114
7	Enter the beginning time for the first event in the format HHMM	1100
8	Enter the ending date for the first event in the format MMDD. If the ending date is the same as the beginning date, press enter	0115
9	Enter the ending time for the first event in the format HHMM	0300
10	Enter the rainfall depth multiplied by 100	21
11	Enter the second rainfall event	0116 1400 <ENTER> 1600 5
12	Enter the third rainfall event	0117 1800 0119 0200 379
13	Enter the fourth rainfall event	0121 2100 0122 0700 46
14	Enter the new rain file name	EX06
15	Exit the program	9 3

## ***Example 2: Edit the Rain File Created in Example 1***

Edit the rain file created in example 1 by:

1. Changing the beginning time of the second rainfall from 14:00 to 13:00
2. Insert this new rain event between events 3 and 4:  
                           01/20/87 03:00 01/20/87 12:00 0.34
3. Changing the rainfall depth of the fourth rainfall from 0.46 to 0.57

Step Number	Command or Model Parameter	Enter Value:
1	Run the parameter module	DPPARA55
2	Select option 1: Rain data files	1
3	Select option 2: Review or edit a rain file	2
4	Enter the name of the rain file you want to edit	EX06
5	Select the option to change a rain event	2
6	Enter the rain number you want to edit	2
7	Change the beginning time of the second rainfall from 14:00 to 13:00 using the format HHMM. Press enter to bypass those values you do not want to change	<ENTER> 1300 <ENTER> <ENTER>
8	Before inserting a new rain event, enter the event year	4 87
9	Add a new rain event	1
10	Enter the rain number you want to insert the new rain after	3
11	Enter the beginning date for the new event in the format MMDD	0120
12	Enter the beginning time for the new event in the format HHMM	0300
13	Enter the ending date for the new event in the format MMDD. If the ending date is the same as the beginning date, press enter	<ENTER>
14	Enter the ending time for the new event in the format HHMM	1200
15	Enter the rainfall depth, multiplied by 100, for the new event	34
16	Select the option to change a rain event	2
17	Enter the rain number you want to edit	5
18	Change the rainfall depth of the fifth rainfall from 0.46 to 0.57. Press enter to bypass those values you do not want to change	<ENTER> <ENTER> <ENTER> <ENTER>
19	Enter the new rain file name	57 EX07
20	Exit the program	9 3

### ***Example 3: Create a Rain File from CD ROM Data***

Use the Parameter Module to create a DETPOND/SLAMM-formatted rain file directly from rainfall data. The program will create the rain file based upon the minimum number of hours between rains and the minimum rainfall event depth values entered by the user. The data must be in the following comma-separated value format, which begins with the date and is followed by 24 values of hourly rain totals:

02/05/1976,0.00 ,0.00 ,0.00 ,0.00 ,0.00 ,0.00 ,0.00 ,0.00 ,0.00 ,0.00 ,0.00 ,0.01 ,0.10 ,0.18 ,0.01 ,0.05 ,0.00 ,0.01 ,0.00 ,0.04 ,0.10 ,0.05 ,0.12 ,0.30

Step Number	Command or Model Parameter	Enter Value:
1	Run the parameter module	DPPARA55
2	Select option 1: Rain data files	1
3	Select option 8: Create a rain file from standard format data	8
4	Enter the name of the comma-separated-value file that you want to convert to a DETPOND/SLAMM rain file. Include the extension	EXHOUR.CSV
5	Enter the name of the file you want to save the rain file created from EXHOUR.CSV	EX08
6	Enter the minimum number of hours you want between rainfall events	4
7	Enter the minimum rainfall depth you want in the rain file	0.01
8	Exit the program	9 3

#### ***Example 4: Stochastically Generate a Rain File***

Statistically evaluate an existing rain file to determine the rank correlation between rainfall depth and duration, the average depth, average duration, and average time between rains. Use this information to create a stochastically generated rainfall series.

Step Number	Command or Model Parameter	Enter Value:
1	Run the parameter module	DPPARA55
2	Select option 1: Rain data files	1
3	Save an existing rain file in a format with duration and interevent calculations appended to the data	4 BHAM77
4	Calculate the statistics for the rain file	7 2 BHAM77.RES
5	Record the results of the rainfall data analysis: Rank Correlation: 0.595 Rainfall Average: 0.62 Duration Average: 0.48 days or 12 hours Interevent Period Average: 3.29 days or 79 hours	
6	Exit the data analysis screen	<ENTER>
7	Select option 6: Create a generated rain file	6
8	Create a generator data file	3
9	Enter a generator file name	1 EX09
10	Enter the mean depth for the generated rain file	2 0.62
11	Enter the minimum recorded rain depth (in)	3 .01
12	Select the rainfall duration distribution (exponential in this example) and enter the mean rain duration, 12 hours, (for both exponential and gamma distributions) and duration variance (gamma distribution only)	4 1 12
13	Enter the mean time between rains (hours)	5 79
14	Enter the minimum time between rains (hours)	6 6
15	Generate 100 events	7 100
16	Select the seed. Enter an integer value or select zero to use the timer	8 42
17	Enter the depth-duration rank correlation coefficient	9 0.595
18	Enter the desired rainfall starting date in the format MMDDYY	10 01/01/88
19	Save the rain generator data file	14
20	Create a generated DETPOND/SLAMM format rain file using the data file you just created	1 EX09
21	Exit the program	9 3

**Example 5: Create a Particle Size Distribution File**

Create a particle distribution file from the MIDWEST data particle size distribution.

Step Number	Command or Model Parameter	Enter Value:
1	Run the parameter module	DPPARA55
2	Select option 2: Particle Size data files	2
3	Select option 1: Create a new particle size distribution file	1
4	Enter the name of the new particle size distribution file	EX10
5	Enter the description of the new particle size distribution file	Midwest
6	For each entry, enter the percent of the particles that are greater than the corresponding critical particle size	for 1 micron: 100 for 2 microns: 98 for 3 microns: 94 for 4 microns: 91 for 5 microns: 88 for 6 micron: 86 for 7 microns: 84 for 8 microns: 82 for 9 microns: 80 for 10 microns: 78 for 11 micron: 75 for 12 microns: 72 for 13 microns: 70 for 14 microns: 67 for 15 microns: 64 for 20 micron: 60 for 25 microns: 57 for 30 microns: 53 for 35 microns: 48 for 40 microns: 44 for 50 microns: 42 for 60 microns: 38 for 80 micron: 34 for 100 microns: 28 for 150 microns: 18 for 200 microns: 16 for 300 microns: 12 for 500 micron: 7 for 800 microns: 4 for 1000 microns: 3 for 2000 microns: 1
17	Exit the program	4 3